



A	04/Feb/2019	Initial release per PIM revision 2
---	-------------	------------------------------------

REV	DATE	MODIFICATIONS
-----	------	---------------

01 - C1 - Cover Sheet	10 - S4 - Structural Details (2)
02 - C2 - Disclaimer - Site Readiness	11 - M1 - HVAC
03 - A1 - General Notes	12 - E1 - Electrical Notes
04 - A2 - Equipment Layout	13 - E2 - Electrical Layout
05 - A3 - Section Views	14 - E3 - Electrical Elevations
06 - A4 - Equipment Details & Delivery	15 - E4 - Details-Interconnections
07 - S1 - Structural Notes	16 - E5 - Power Requirements
08 - S2 - Structural Layout	
09 - S3 - Structural Details (1)	

A mandatory component of this drawing set is the GE Healthcare Pre Installation manual. Failure to reference the Pre Installation manual will result in incomplete documentation required for site design and preparation.
 Pre Installation documents for GE Healthcare products can be accessed on the web at: www.gehealthcare.com/siteplanning

GE does not take responsibility for any damages resulting from changes on drawings made by others. Errors may occur by not referring to the complete set of final issue drawing. GE cannot accept responsibility for any damage due to the partial use of GE final issue drawings, however caused. All dimensions are in millimeters unless otherwise specified. Do not scale from printed pdf files. GE accepts no responsibility or liability for defective work due to scaling from these drawings.

Typical					

	GE Healthcare	----
---	----------------------	------

DISCOVERY XR 656 HD (G3) FINAL STUDY					
---	--	--	--	--	--

Drawn by	Verified by	Concession	S.O. (GON)	PIM Manual	Rev
DTC	REK	-	----	5643942-1EN	2
Format	Scale	File Name		Date	Sheet
A3	1/4"=1'-0"	EN-RAD-TYP-XR_656_HD_(G3)-WEB.DWG		15/Aug/2019	01/16

DISCLAIMER

GENERAL SPECIFICATIONS

- GE is not responsible for the installation of developers and associated equipment, lighting, cassette trays and protective screens or derivatives not mentioned in the order.
- The final study contains recommendations for the location of GE equipment and associated devices, electrical wiring and room arrangements. When preparing the study, every effort has been made to consider every aspect of the actual equipment expected to be installed.
- The layout of the equipment offered by GE, the dimensions given for the premises, the details provided for the pre-installation work and electrical power supply are given according to the information noted during on-site study and the wishes expressed by the customer.
- The room dimensions used to create the equipment layout may originate from a previous layout and may not be accurate as they may not have been verified on site. GE cannot take any responsibility for errors due to lack of information.
- Dimensions apply to finished surfaces of the room.
- Actual configuration may differ from options presented in some typical views or tables.
- If this set of final drawings has been approved by the customer, any subsequent modification of the site must be subject to further investigation by GE about the feasibility of installing the equipment. Any reservations must be noted.
- The equipment layout indicates the placement and interconnection of the indicated equipment components. There may be local requirements that could impact the placement of these components. It remains the customer's responsibility to ensure that the site and final equipment placement complies with all applicable local requirements.
- All work required to install GE equipment must be carried out in compliance with the building regulations and the safety standards of legal force in the country concerned.
- These drawings are not to be used for actual construction purposes. The company cannot take responsibility for any damage resulting therefrom.

CUSTOMER RESPONSIBILITIES

- It is the responsibility of the customer to prepare the site in accordance with the specifications stated in the final study. A detailed site readiness checklist is provided by GE. It is the responsibility of the customer to ensure all requirements are fulfilled and that the site conforms to all specifications defined in the checklist and final study. The GE Project Manager of Installation (PMI) will work in cooperation with the customer to follow up and ensure that actions in the checklist are complete, and if necessary, will aid in the rescheduling of the delivery and installation date.
- Prior to installation, a structural engineer of record must ensure that the floor and ceiling is designed in such a way that the loads of the installed system can be securely borne and transferred. The layout of additional structural elements, dimensioning and the selection of appropriate installation methods are the sole responsibility of the structural engineer. Execution of load bearing structures supporting equipment on the ceiling, floor or walls are the customer's responsibility.

RADIO-PROTECTION

- Suitable radiological protection must be determined by a qualified radiological physicist in conformation with local regulations. GE does not take responsibility for the specification or provision of radio-protection.

THE UNDERSIGNED, HEREBY CERTIFIES THAT I HAVE READ AND APPROVED THE PLANS IN THIS DOCUMENT.		
DATE	NAME	SIGNATURE

GLOBAL SITE READINESS CHECKLIST (DI)

DOC1809666 Rev. 6

Customer Name:	PMI Name:
GON/SO Number:	Field Service Name:
Equipment:	Country/City or City/State:
Site Visit Date for SRC:	SRC Status:
Site Ready Checks at Installation	
General Site Planning	
Room dimensions, including ceiling height, for all Exam, Equipment/Technical & Control rooms meets GE specifications.	
Ceiling support structure, if on the GE drawing, is at correct location and height according to the drawing specifications. Levelness and spacing has been measured. Overhead support Structure has been confirmed with contractor to meet GE criteria.	
Rooms that will contain equipment, including staging areas if applicable, are construction debris free. Precautions must be taken to prevent debris from entering rooms containing equipment.	
Finished ceiling is installed. If applicable ceiling tiles installed per PMI discretion.	
Delivery route from truck to installation space has been reviewed, all communications have occurred, arrangements made for special handling (if needed). Floors along delivery route will support weight of the equipment, reinforcements arranged if needed.	
System power & grounding (PDB/MDP) is available as per GE specifications, installed at point of final connection and ready to use. Lock Out Tag Out is available.	
System power and grounded audit has been scheduled to be completed during installation of equipment. (If Required) GEHC PM to confirmed if needed.	
Adequate room illumination installed and working.	
Cableways (floor, wall, ceiling, etc.) ready for GE cables and are of correct length and diameter. Cableways routed per GE Final drawings and access openings installed as determined by GEHC PM. Surface floor duct installed at time of system installation.	
HVAC systems Installed, and the site meets minimum environmental operational system requirements.	
Network outlets installed and computer network available and working.	
Hospital IT/connectivity contacts have been engaged and information has been added to Project management tool. (If Required)	
Floor levelness/flatness is measured and within tolerance, and there are no visible defects per GEHC specifications. Floor Strength and thickness have been discussed with customer/contractor and they have confirmed GE requirements are met.	
Customer supplied countertops where GE equipment will be installed are in place.	
Specific for CT & X-ray	
Doors and windows complete or scheduled to be installed. If applicable, radiation protection (shielding) finished & radioprotection regulatory approval for installation obtained.	
PMI Signature:	
Customer Signature:	
FS Signatature: optional	

CUSTOMER SITE READINESS REQUIREMENTS

- Any deviation from these drawings must be communicated in writing to and reviewed by your local GE healthcare installation project manager prior to making changes.
- Make arrangements for any rigging, special handling, or facility modifications that must be made to deliver the equipment to the installation site. If desired, your local GE healthcare installation project manager can supply a reference list of rigging contractors.
- New construction requires the following;
 1. Secure area for equipment,
 2. Power for drills and other test equipment,
 3. Capability for image analysis,
 4. Restrooms.
- Provide for refuse removal and disposal (e.g. crates, cartons, packing)
- It is the customer's responsibility to contract a vibration consultant/engineer to implement site design modifications to meet the GE vibration specification. Refer to the system preinstallation manual for the vibration specification.

ENVIRONMENTAL SPECIFICATIONS

MAGNETIC INTERFERENCE

To guarantee specified imaging performance :
X-ray tubes and control console equipment must be located in ambient static field of less than 10 gauss.

LIGHT REQUIREMENTS

For the electronic ballast of fluorescent lamp in exam room, the operating frequency should be above 42KHz.

ACOUSTIC OUTPUT

Measured 1 m from any point in system.
In-use: less than 55 dBA
Stand-by: less than 55 dBA

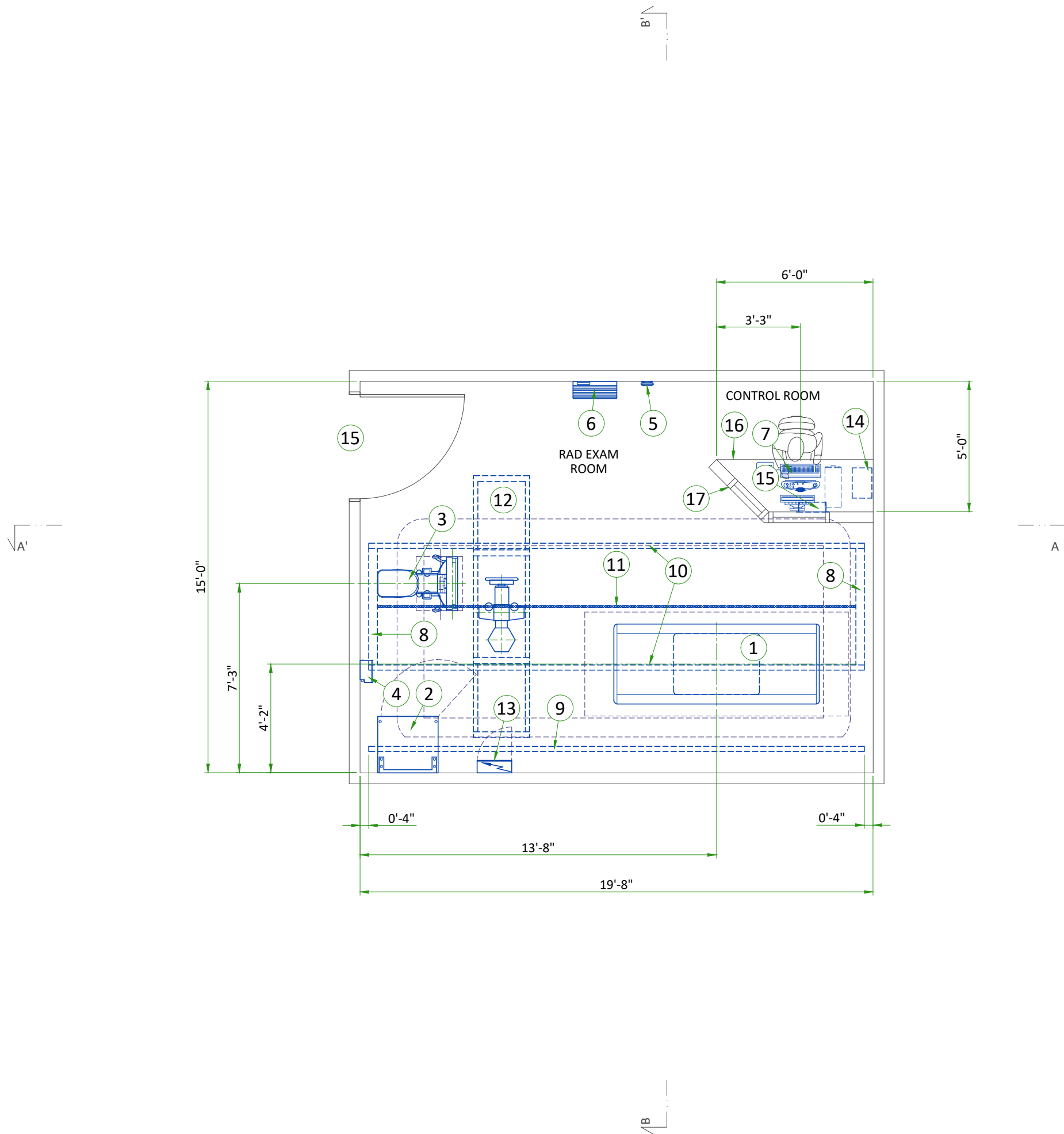

LEGEND

A	GE Supplied	C	Customer/contractor supplied and installed
B	GE Supplied/contractor installed	D	Available from GE
E	Existing		

BY	ITEM	DESCRIPTION	MAX HEAT OUTPUT (btu)*	WEIGHT (lbs)	MAX HEAT OUTPUT (W)*	WEIGHT (kg)
A	1	Elevating Table	-	661	-	300
A	2	Systems Cabinet	-	705	-	320
A	3	Wall Stand	-	624	-	284
A	4	Tether Interface Box	-	13.4	-	6
A	5	Access Point	-	1.3	-	0.6
A	6	Grid Holder	-	30.4	-	13.8
A	7	Operators Console	-	56.6	-	25.7
A	8	Anchor Rails	-	43.5	-	19.7
A	9	Cable Drape Rail	-	65	-	29.5
A	10	Longitudinal Stationary Rail for OTS	-	138	-	62.6
A	11	Longitudinal Drive Belt	-	-	-	-
A	12	OTS with 3m Bridge	-	1087	-	592
B/D	13	Main Disconnect Panel	-	-	-	-
D	14	Partial UPS	-	76	-	34.5
A	15	Wall Box	-	-	-	-
C	16	Minimum opening for equipment delivery is 36 in. w x 66.9 in. h, contingent on a 96 in. corridor width (Note: Image Paste option requires an 80.9 in H opening)				
C	17	Counter top for equipment- provide grommeted openings as required to route cables				
C	18	Control wall, 7 Ft. high with lead glass viewing window				

*Refer to heat dissipation detail on page M1 for system heat load information

Applications

The chart shows the applications possible to perform with the present equipment positioning, however the sales contract may not include all of them.

Auto Image Pasting at Wall Stand	YES
Auto Image Pasting at Table	YES
VolumeRAD	
Horizontal at Extended Arm Wall stand	NO
Vertical at Wall stand	YES
Cross-Table at Wall stand	YES
Horizontal at Table	YES

The following shots are NOT available in this layout

Rear to front cross table shot

Exam room height

Finished floor to slab height	TBD
Recommended finished ceiling height	9'-6"

The [GE HPI Technical Support Group](#) is an additional resource that can provide answers for general GE product siting questions and can be reached at (877)-305-9677 or mail to: HPI_TechCOE@ge.com

For [Accessory Sales](#): (866) 281-7545 Options 1, 2, 1, 2 or mail to: gehaccessorysales@ge.com

SIDE VIEW A-A'

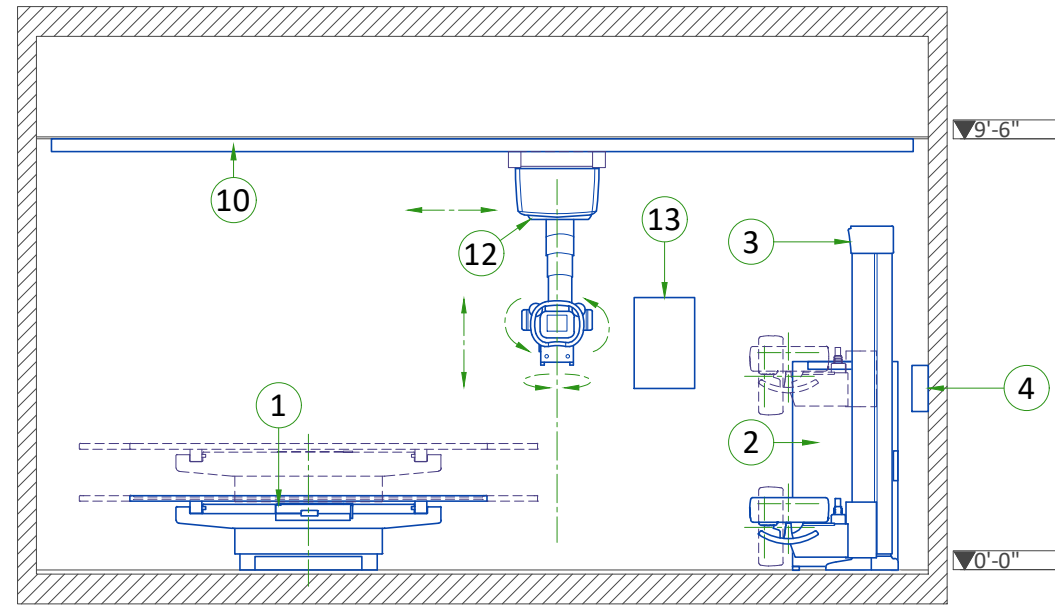

EXAM ROOM CEILING HEIGHTS

RECOMMENDED AND MINIMUM ROOM HEIGHTS

CONFIGURATION	SPECIFICATION	CEILING HEIGHT [mm]	CEILING HEIGHT [in]
2m, 3m or 4-meter Bridge	Recommended	2895.6 mm	114 in
2m, 3m Bridge with Advanced Applications	Minimum	2692.4 mm	106 in
2m, 3m Bridge without Advanced Applications	Minimum	2616.2 mm	103 in
4m Bridge with Advanced Applications	Minimum	2698.75 mm	106.25 in
4m Bridge without Advanced Applications	Minimum	2622.55 mm	103.25 in
3m Bridge with Wallstand at Front Position	Minimum	2870 mm	113 in
4m Bridge with Wallstand at Front Position	Minimum	2876.35 mm	113.25 in

Note : measured from the floor to the top of the longitudinal rails

FRONT VIEW B-B'

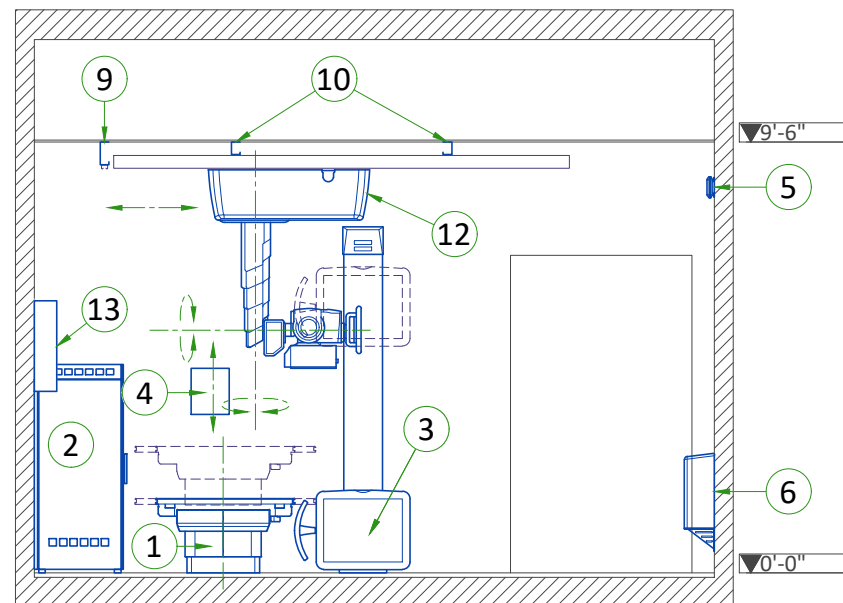

CLEARANCE AREAS

GLOBAL G3 TABLE WITH STANDARD WALLSTAND

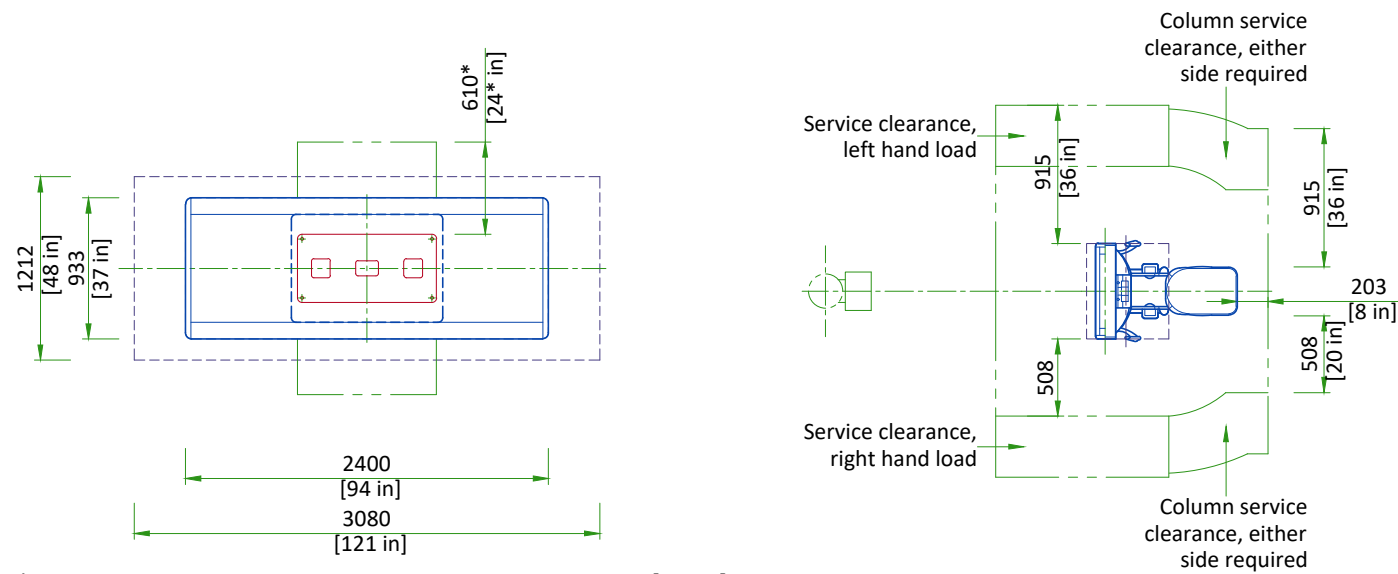

*Recommended service access clearance is 915 mm [36 in].

SCALE 1:50

DELIVERY

THE CUSTOMER/CONTRACTOR SHOULD:

- Provide an area adjacent to the installation site for delivery and unloading of the GE equipment.
- Ensure that the dimensions of all doors, corridors, ceiling heights are sufficient to accommodate the movement of GE equipment from the delivery area into the definitive installation room.
- Ensure that access routes for equipment will accommodate the weights of the equipment and any transportation, lifting and rigging equipment.
- Ensure that all necessary arrangements for stopping and unloading on public or private property not belonging to the customer have been made.

DIMENSIONS OF DELIVERY IN TRANSIT

EQUIPMENT	DIMENSIONS			WEIGHT	
	LENGTH	WIDTH	HEIGHT		
STANDARD WALLSTAND	LENGTH	2111 mm	83.1 in	270 kg + fixture	596 lbs + fixture
	WIDTH	911 mm	35.9 in		
	HEIGHT	1860 mm	73.2 in		
G2 TABLE	LENGTH	2400 mm	94.5 in	440 kg + dolly	970 lbs + dolly
	WIDTH	940 mm	37 in		
	HEIGHT	800 mm	31.5 in		

Pay attention to the lengths of the rails! They can be also 6 m [19.7 ft]!

ACCESS POINT POSITION

AP Wall-mounting position:

- There are 6 different positions available for AP wall-mounting.
- Install at more than 2.5 m [8.2 ft] height from floor level to avoid potential blocking from human or other obstacles.
- One Ethernet cable to Magic PC and one power cable to system cabinet are connected on the back of the AP.
- Use wall mount adapter included with AP.

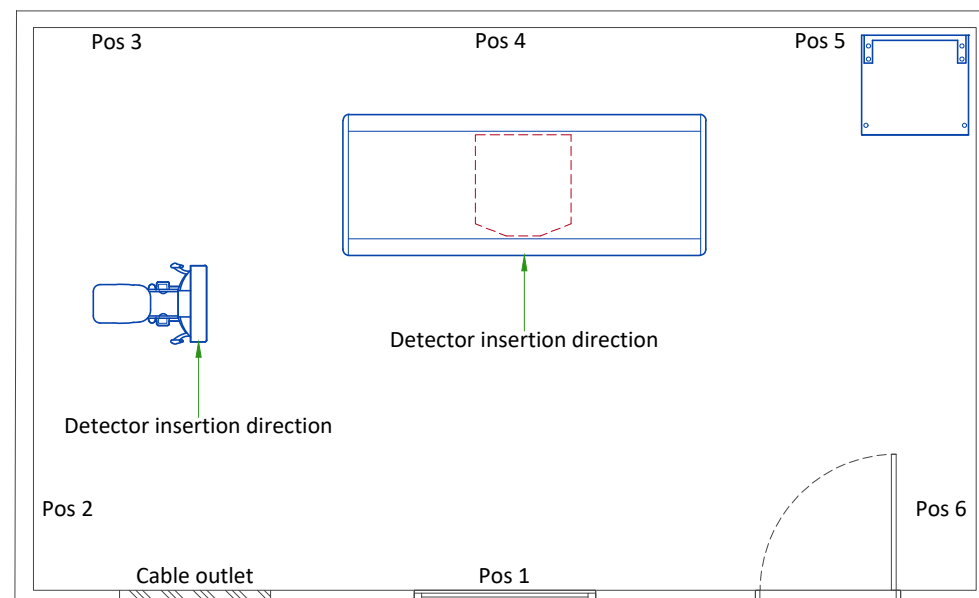

STRUCTURAL NOTES

- Methods of support for the steelwork that will permit attachment to structural steel or through bolts in concrete construction should be favored. Do not use concrete or masonry anchors in direct tension.
- All units that are wall mounted or wall supported are to be provided with supports where necessary. Wall supports are to be supplied and installed by the customer or his contractors. See plan for suggested locations.
- Control walls shall be constructed to minimum 2130mm (7'-0") high.
- Dimensions are to finished surfaces of room.
- Customers contractor must provide all penetrations in post tension floors.
- Customers contractor must provide and install any non-standard anchoring. Documents for standard anchoring methods are included with GE equipment drawings for geographic areas that require such documentation.
- Customers contractor must provide and install hardware for "through the floor" anchoring and/or any bracing under access floors. This contractor must also provide floor drilling that cannot be completed because of an obstruction encountered while drilling by the GE installer such as rebar etc.
- It is the customer's responsibility to perform any floor or wall penetrations that may be required. The customer is also responsible for ensuring that no subsurface utilities (e.g., electrical or any other form of wiring, conduits, piping, duct work or structural supports (i.e. post tension cables or rebar)) will interfere or come in contact with subsurface penetration operations (e.g. drilling and installation of anchors/screws) performed during the installation process. To ensure worker safety, GE installers will perform surface penetration operations only after the customer's validation and completion of the "GE surface penetration permit".
- Different anchor types are used to install the components of the system. Refer to Structural Requirements Section(s) of the Pre-Installation Manual for each anchor requirement.
- Refer to the Structural Requirements Section for the required minimum embedment.
- The ground surface must be flat and leveled, maximum tolerance for leveling is ± 1.5 mm per 1 m (0.2 in per 10 feet). A grout pad provided by the contractor is required to meet this specification. The maximum pad thickness is 6.3 mm (0.25 in).

CEILING REQUIREMENTS

To allow installation of the stationary rail cross-members, clearance is required between the ends of the stationary rails and the walls.

It is recommended that sprinkler heads not be placed between the stationary rails. All sprinkler heads should be mounted so they do not extend downward more than 6.35 mm from the ceiling while in the 'resting' position.

In addition, there should not be anything mounted in the ceiling (i.e. lights, A/C returns, etc) between the stationary rails. This is because the OTS longitudinal drive belt assembly is located on the movable bridge, approximately centered between the two stationary rails, and may come into contact with those ceiling-mounted items during normal use.

Stationary rails are designed for top (ceiling) mounting. Rails can be ordered and are supplied in 10.2 cm increments between 3.4 m and 5.64 m, plus a 5.79 m length totaling 24 different sizes. The choice of length depends on room size, configuration and the possible presence of obstructions.

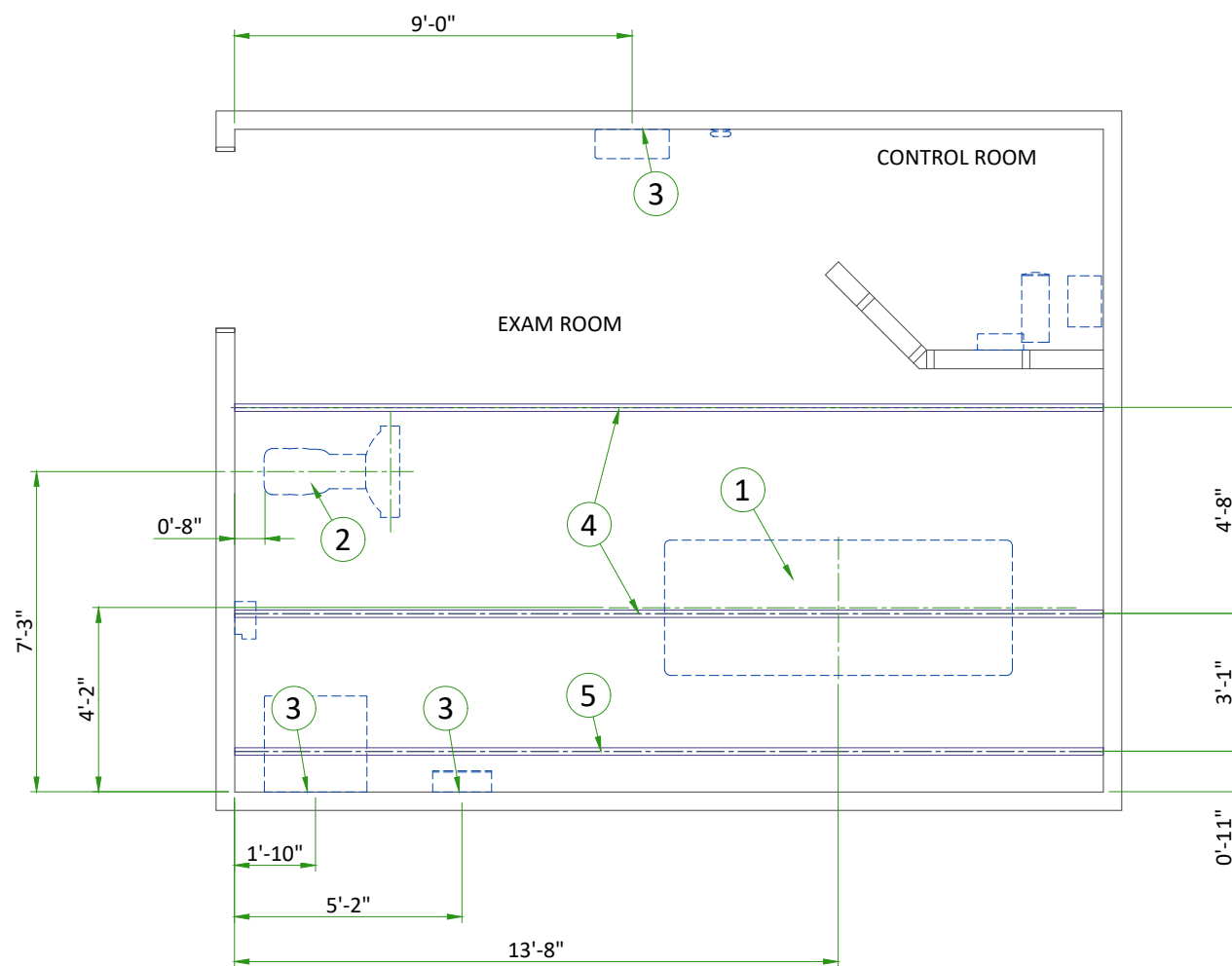

ITEM	DESCRIPTION
(GE SUPPLIED / CONTRACTOR INSTALLED)	
1	Area occupied by GE supplied table baseplate
2	Area occupied by GE supplied wall stand baseplate
(CONTRACTOR SUPPLIED & INSTALLED)	
3	Support backing, locate as shown.
4	Structural support in ceiling for fastening ceiling supported equipment. Supports to run continuous with no fittings extending below face of channel, run wall to wall, be parallel, square, and in the same horizontal plane, flush with the finished ceiling. Rails are mounted to these supports every 2'-2" and require 350 lbs. (597 lbs. In seismic regions) per bolt load. Methods of support that permit attachment to structural steel or through bolts in concrete should be favored. Do not use screw anchors in direct tension.
5	Structural support in ceiling for fastening cable drape rail. Supports to run continuous with no fittings extending below face of channel, run wall to wall, be parallel, square, and in the same horizontal plane, flush with the finished ceiling. Rails are mounted to these supports every 2'-2" and require 50 lbs. Per bolt load. Methods of support that permit attachment to structural steel or through bolts in concrete should be favored. Do not use screw anchors in direct tension.

TABLE ANCHORING

TABLE STAND

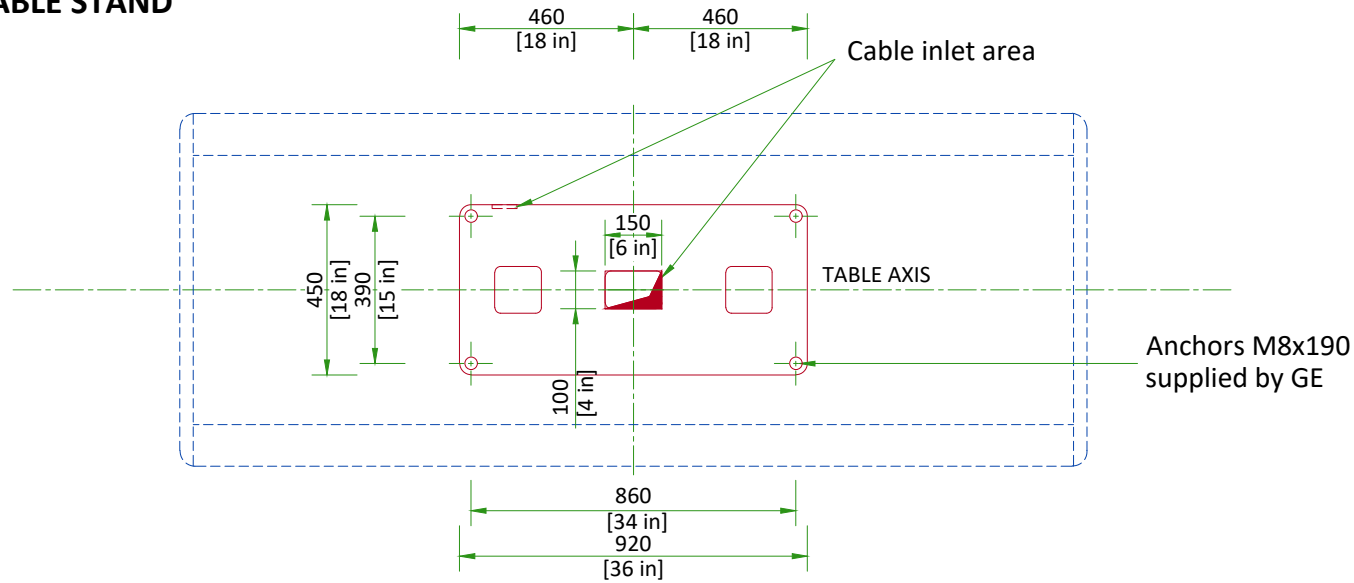

The floor bearing the system is recommended to be concrete and the thickness to be determined by a Structural Engineer to properly support the equipment loads. The supplied anchors require a minimum embedment of 90 mm [3.54 in] into the concrete. If the floor thickness is less than 95 mm [3.74 in], it is recommended that the unit be secured using a through-bolt method with a reinforcement plate on the back side.

NOTE: It is the responsibility of the customer/contractor/Structural engineer to design/provide/and install an alternate solution for anchoring if the anchors supplied by GE can't be used.

SCALE 1:20

OTS SUSPENSION RAILS MOUNTING SPECIFICATIONS

3 m BRIDGE

When a 22.7 kg [50 lb] force is applied vertically upward, downward or horizontally at any support rail mounting point, the attachment interface must not deflect more than 1.5 mm [1/16 in]

When a 136 kg [300 lb] load is applied vertically downward or horizontally at any stationary rail mounting point, the attachment interface must not deflect more than 1.5 mm [1/16 in]

660.4 ±1.5 mm [26 ±1/16 in]

Cable takeup support rail mounting points

Stationary rail mounting points must be parallel within ±3 mm [±1/8 in]

When a 45.4 kg [100 lb] force is applied vertically upward at any stationary rail mounting point, the attachment interface must not deflect more than 1.5 mm [1/16 in]

min. 883/rec. 950 ±3 mm [min. 34.8/rec. 37.4 ±1/8 in]

1422 ±3 mm [56 ±1/8 in]

Diagonals must be equal within ±6.5 mm [±1/4 in]

All mounting point must be located on a common centerline within ±1.5 mm [±1/16 in]

All mounting points must be in the same horizontal plane within ±2.4mm [±3/32 in]

Distance between holes axis 660.4 mm [26 in], Maximum load per screw is 159 kg [350 lb], however each mounting screw must not "PULL OUT" or otherwise fail under a vertically downward dead load of 636 kg [1400 lb]. Bolts for mounting stationary rails on Unistrut or equivalent supplied by GE (1/2" - 13 headed bolts)

WALLSTAND ANCHORING

WALLSTAND BASE

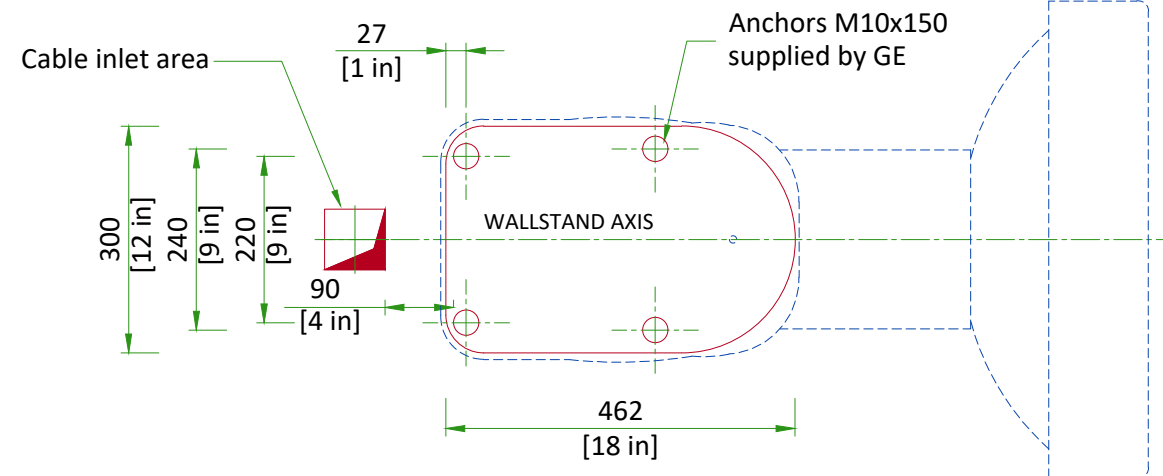

Concrete area for wall stand installation should be 1 m² [39.37 in²].

NOTE: It is the responsibility of the customer/contractor/Structural engineer to design/provide/and install an alternate solution for anchoring if the anchors supplied by GE can't be used.

SCALE 1:10

FOCAL SPOT TRAVEL

3 m BRIDGE

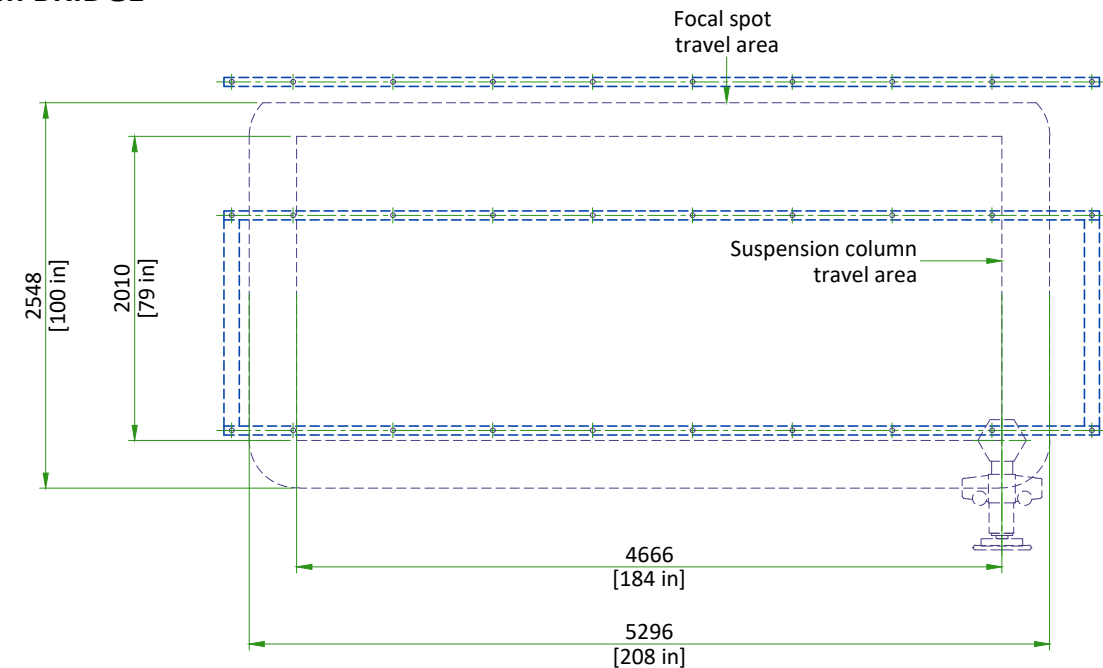

SCALE 1:50

XT RADIOGRAPHIC SUSPENSION, INBOARD MOUNTING

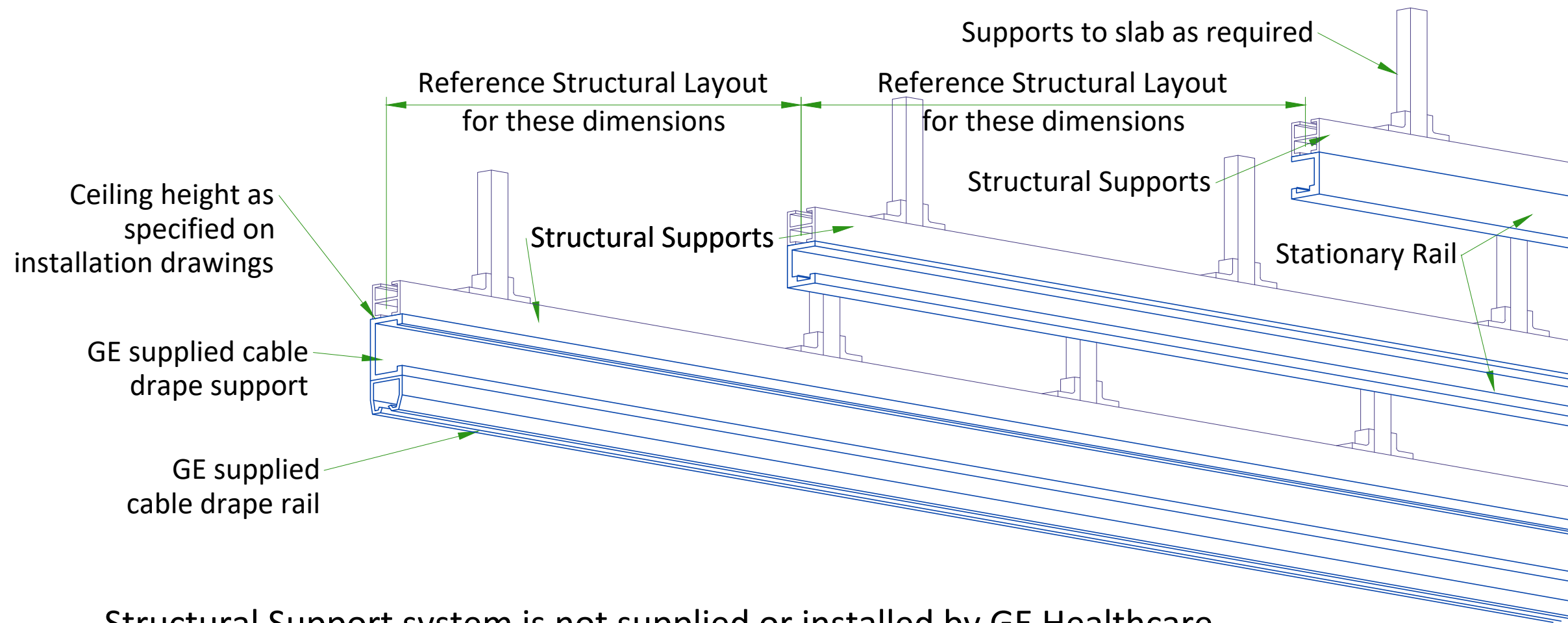

Structural Support system is not supplied or installed by GE Healthcare

DETAIL 1

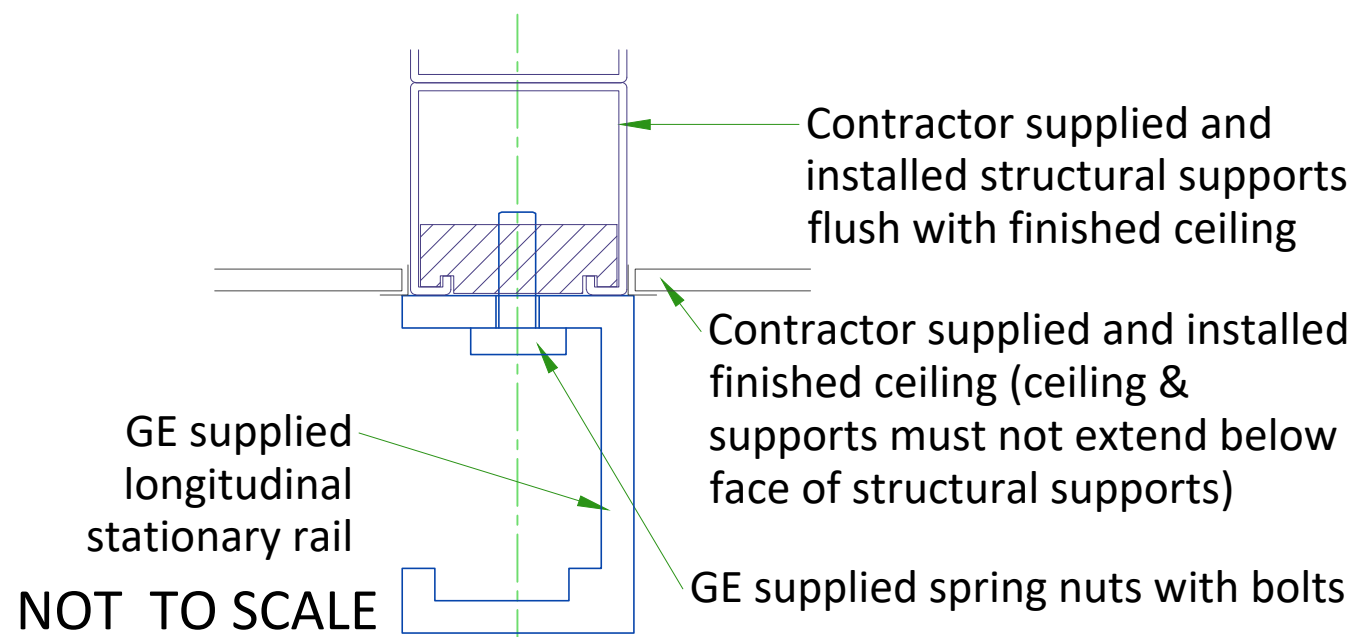

DETAIL 2

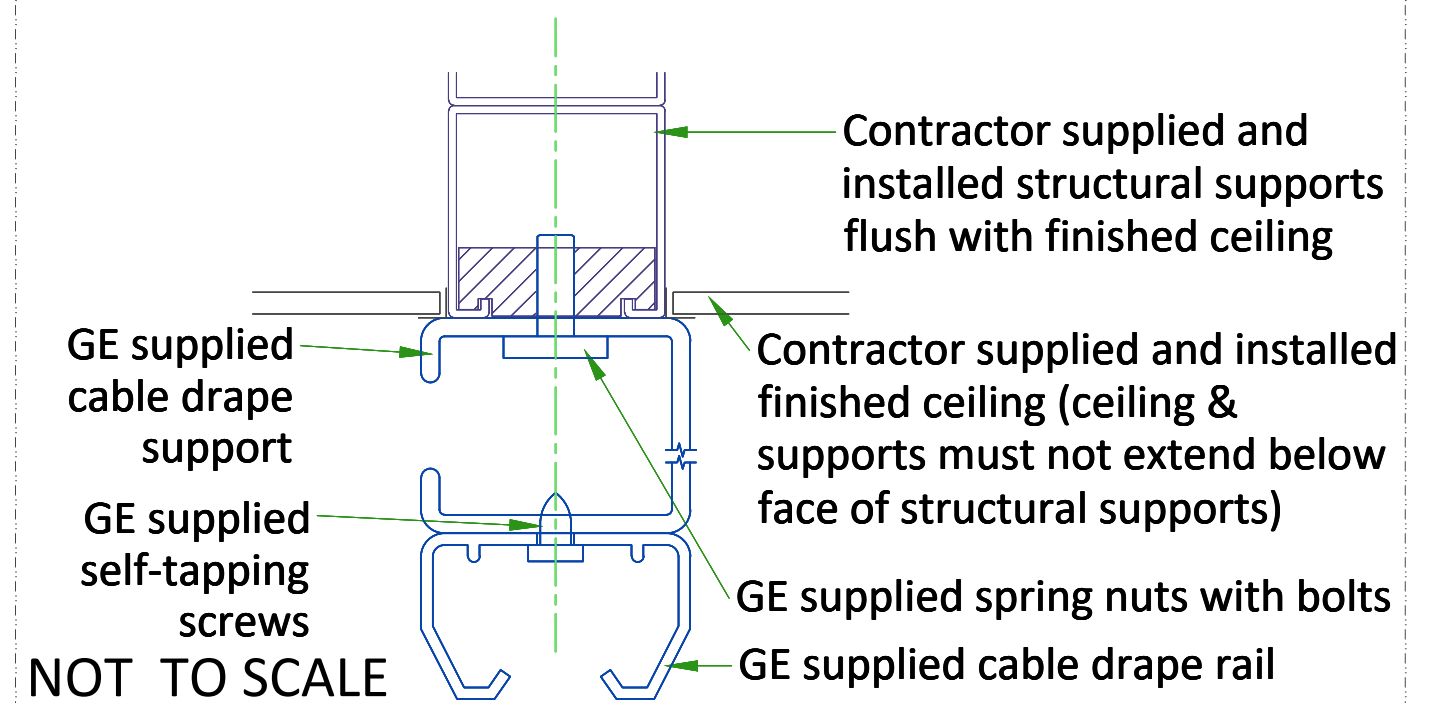

TEMPERATURE AND HUMIDITY SPECIFICATIONS

IN-USE CONDITIONS

	EXAM ROOM		CONTROL ROOM	
	Min	Max	Min	Max
Temperature	15°C [59°F]	35°C [95°F]	15°C [59°F]	35°C [95°F]
Temperature gradient	< 10°C/h [< 50°F/h]		< 10°C/h [< 50°F/h]	
Relative humidity (1)	30% to 60%		30% to 60%	
Humidity gradient	< 30%/h		< 30%/h	

STORAGE CONDITIONS

Temperature	-5°C [23°F] to +50°C [122°F]
Temperature gradient	< 20°C/h [< 68°F/h]
Relative humidity (1)	10% to 85%
Humidity gradient	< 30%/h

Storage longer than 90 days is not recommended.

(1) Non-condensing

AIR RENEWAL

According to local standards.

NOTE

In case of using air conditioning systems that have a risk of water leakage it is recommended not to install it above electric equipment or to take measures to protect the equipment from dropping water.

HEAT DISSIPATION DETAILS

SYSTEM POWER CONSUMPTION	HEAT OUTPUT			
	STANDBY		IN-USE	
Standby Power	1.0 kW	3412 BTU/hr		
Standby Current	2.0 A			
Continuous Power			2.2 kW	7507 BTU/hr
Continuous Current			4.5 A	

CONNECTIVITY REQUIREMENTS

Broadband Connections are necessary during the installation process and going forward to ensure full support from the Engineering Teams for the customers system. Maximum performance and availability for the customers system is maintained and closely monitored during the lifetime of the system. Proactive and reactive maintenance is available utilising the wide range of digital tools using the connectivity solutions listed below:

- Site-to-Site VPN/GE Solution
- Site-to-Site VPN/Customer Solution
- Connection through Dedicated Service Network
- Internet Access - connectivity for InSite 2.0

The requirements for these connectivity solutions are explained in the broadband solutions catalogue (separate document).

ELECTRICAL NOTES

1. All wires specified shall be copper stranded, flexible, thermo-plastic, color coded, cut 10 foot long at outlet boxes, duct termination points or stubbed conduit ends. All conductors, power, signal and ground, must be run in a conduit or duct system. Electrical contractor shall ring out and tag all wires at both ends. Wire runs must be continuous copper stranded and free from splices.
 - 1.1. Aluminum or solid wires are not allowed.
2. Wire sizes given are for use of equipment. Larger sizes may be required by local codes.
3. It is recommended that all wires be color coded, as required in accordance with national and local electrical codes.
4. Conduit sizes shall be verified by the architect, electrical engineer or contractor, in accordance with local or national codes.
5. Convenience outlets are not illustrated. Their number and location are to be specified by others. Locate at least one convenience outlet close to the system control, the power distribution unit and one on each wall of the procedure room. Use hospital approved outlet or equivalent.
6. General room illumination is not illustrated. Caution should be taken to avoid excessive heat from overhead spotlights. Damage can occur to ceiling mounting components and wiring if high wattage bulbs are used. Recommend low wattage bulbs no higher than 75 watts and use dimmer controls (except mr). Do not mount lights directly above areas where ceiling mounted accessories will be parked.
7. Routing of cable ductwork, conduits, etc., must run direct as possible otherwise may result in the need for greater than standard cable lengths (refer to the interconnection diagram for maximum usable lengths point to point).
8. Conduit turns to have large, sweeping bends with minimum radius in accordance with national and local electrical codes.
9. A special grounding system is required in all procedure rooms by some national and local codes. It is recommended in areas where patients might be examined or treated under present, future, or emergency conditions. Consult the governing electrical code and confer with appropriate customer administrative personnel to determine the areas requiring this type of grounding system.
10. The maximum point to point distances illustrated on this drawing must not be exceeded.
11. Physical connection of primary power to GE equipment is to be made by customers electrical contractor with the supervision of a GE representative. The GE representative would be required to identify the physical connection location, and insure proper handling of GE equipment.
12. GEHC conducts power audits to verify quality of power being delivered to the system. The customer's electrical contractor is required to be available to support this activity.

- All junction boxes, conduit, duct, duct dividers, switches, circuit breakers, cable tray, etc., are to be supplied and installed by customers electrical contractor.
- Conduit and duct runs shall have sweep radius bends
- Conduits and duct above ceiling or below finished floor must be installed as near to ceiling or floor as possible to reduce run length.
- Ceiling mounted junction boxes illustrated on this plan must be installed flush with finished ceiling.
- All ductwork must meet the following requirements:
 1. Ductwork shall be metal with dividers and have removable, accessible covers.
 2. Ductwork shall be certified/rated for electrical power purposes.
 3. Ductwork shall be electrically and mechanically bonded together in an approved manner.
 4. PVC as a substitute must be used in accordance with all local and national codes.
- All openings in access flooring are to be cut out and finished off with grommet material by the customers contractor.
- General contractor to insert pull cords for all cable run conduits between the equipment room and the operators control room.
- 10 foot pigtails at all junction points.
- Grounding is critical to equipment function and patient safety. Site must conform to wiring specifications shown on this plan.

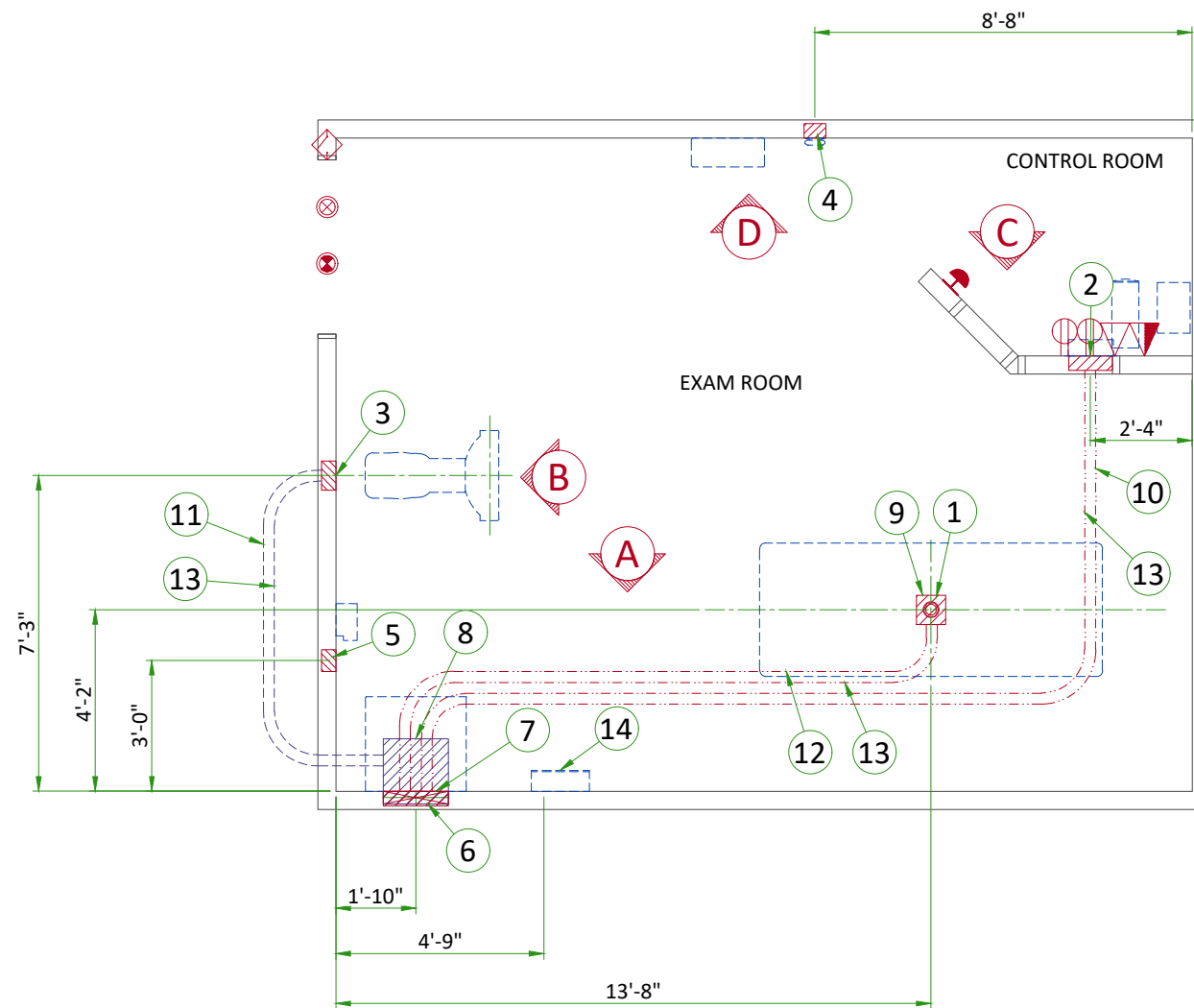

ELECTRICAL LAYOUT ITEM LIST

1	Suitable bushings & locknuts
2	Flush 12"x6"x4" box for Control
3	Flush J-box for Chest Unit - size per local code
4	Flush J-box for Dongle - size per local code
5	Flush J-box for TIB - size per local code
6	Flush J-box for Generator - size per local code
7	18" x 3 1/2" [450mm x 100mm] Flush vertical wall duct with minimum 2 dividers
8	Box above ceiling size per local code
9	Box below floor size per local code
10	One 1" cnd
11	One 1 1/2" cnd
12	One 2" cnd
13	One 2 1/2" cnd
14	Main Disconnect Panel

ITEM Outlet Legend for GE Equipment

	System emergency off (SEO), (recommended height 1.2m [48"] above floor)
	X-Ray room warning light control panel
	X-Ray ON lamp (L1) - 24V
	Door interlock switch (needed only if required by state/local codes)
	Duplex hospital grade, dedicated wall outlet 120-v, single phase power
	Dedicated telephone line(s)
	Network outlet

Conduit Legend

	Above Ceiling
	Below Floor

Additional Conduit Runs (Contractor Supplied and Installed)

From	To	Qty	Size	
			In.	mm
3 phase power	Main disconnect	1	AS REQ'D	AS REQ'D
Main disconnect	Emergency off	1	1/2	16
	Systems Cabinet	1	AS REQ'D	AS REQ'D
Warning light	Warning light control	1	1/2	16
		1	AS REQ'D	AS REQ'D
Systems Cabinet	Door Switch	1	1/2	16
	TIB	2	2	53
	Access Point	1	1	27
	Operators Console	TIB	1	1
Operators Console	Access Point	1	2	53

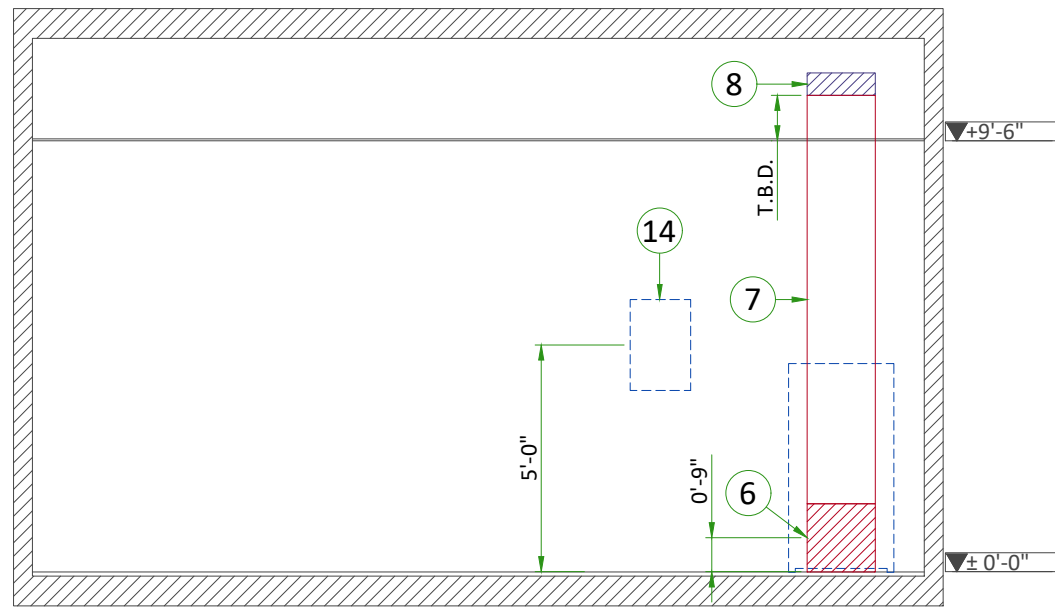

A

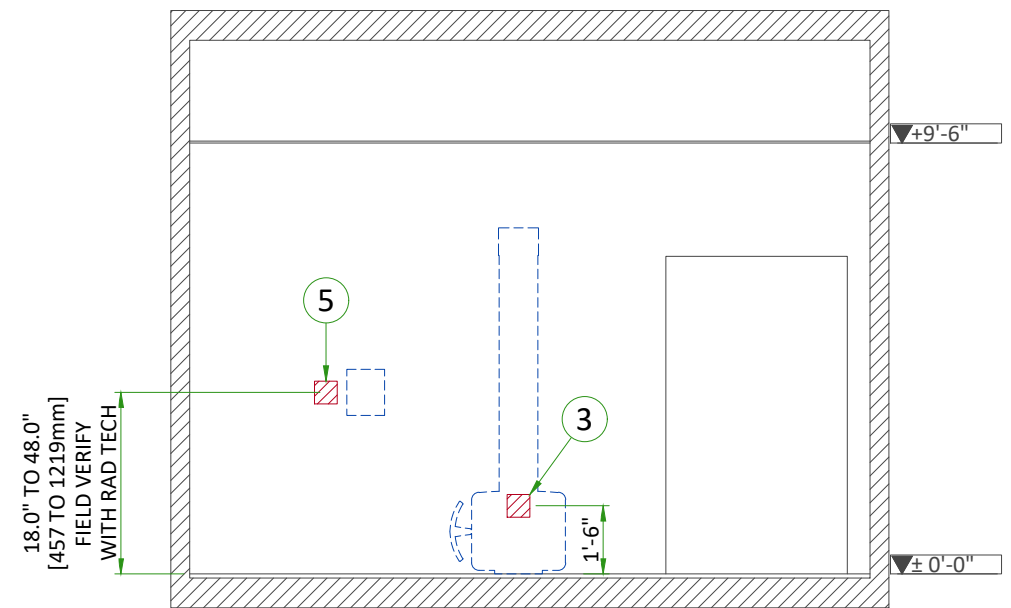

B

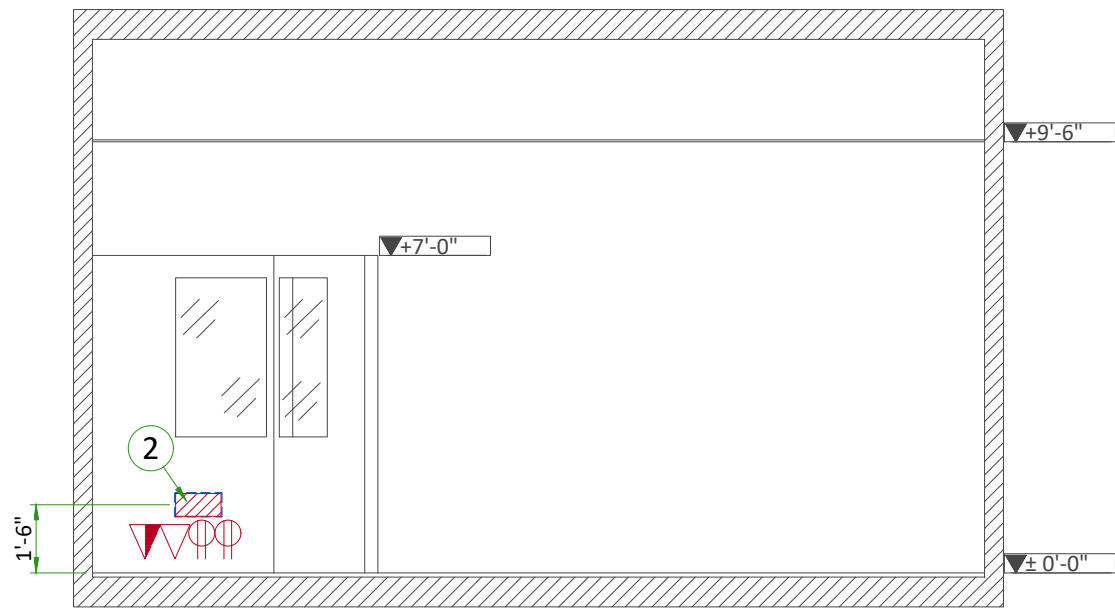

C

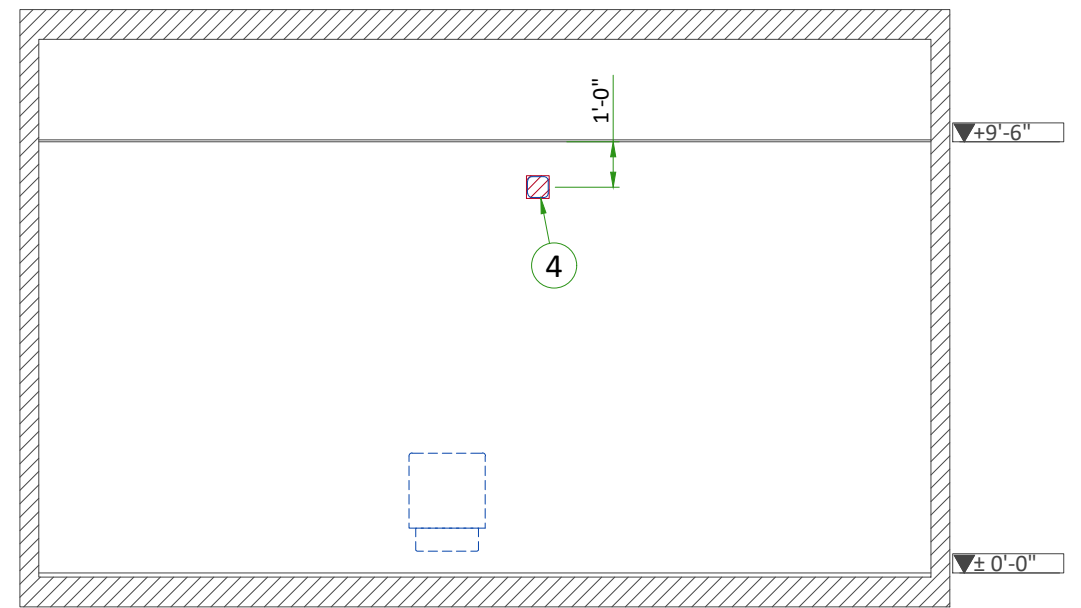

D

INTERCONNECTIONS

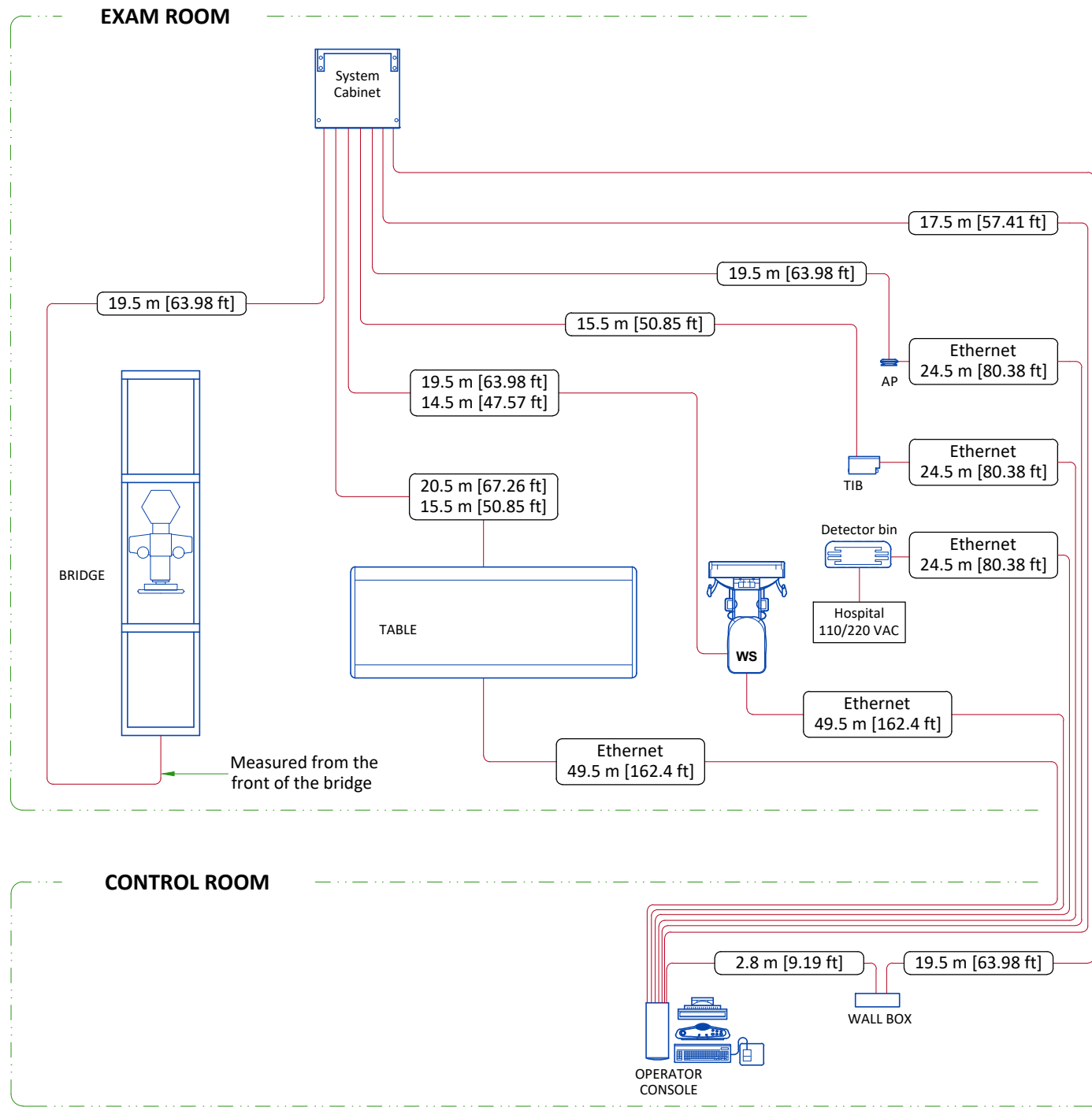

.....m [.....ft] - Long usable length
m [.....ft] - Standard usable length

CABLE MANAGEMENT

CONDUIT IN THE FLOOR

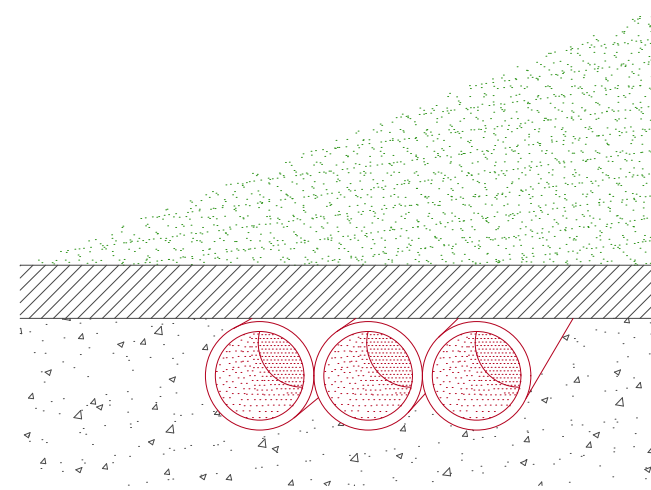

VERTICAL DUCT ON WALL

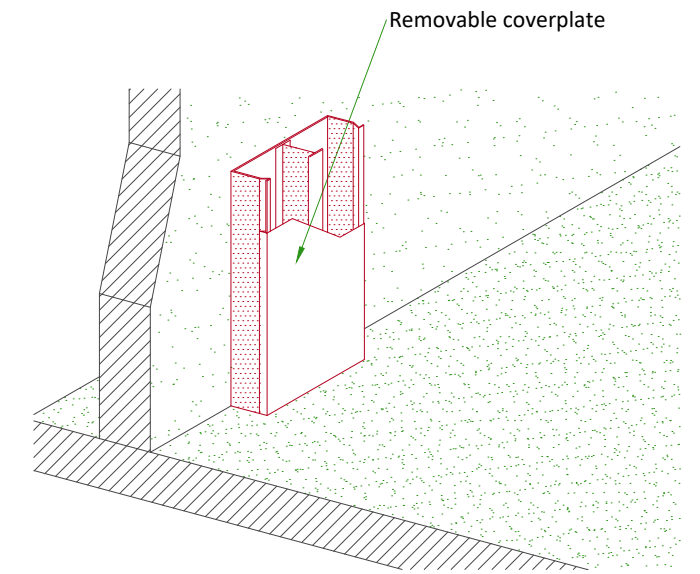

NOT TO SCALE

POWER REQUIREMENTS

POWER SUPPLY	380/400/415/440/460/480V ±10%, THREE-PHASE + G
FREQUENCIES	50/60Hz ± 3Hz
POWER DEMAND	125kVA
MAXIMUM LINE RESISTANCE PER 2 PHASES (Ohm)	380V : 0.096/ 400V : 0.100 / 415V : 0.113 440V : 0.125 / 480V : 0.150

- Power supply should come into a main disconnect panel (MDP) containing the protective units and controls.
- The section of the supply cable should be calculated in accordance with its length and the maximum permissible voltage drops.
- There must be discrimination between supply cable protective material at the beginning of the installation (main low-voltage transformer side) and the protective devices in the MDP.

SUPPLY CHARACTERISTICS

- Power input must be separated from any others which may generate transients (elevators, air conditioning, radiology rooms equipped with high speed film changers...)
- All equipment (lighting, power outlets, etc...) installed with GE system components must be powered separately.

GROUND SYSTEM

- Equipotential : the equipotential link will be by means of an equipotential bar. This equipotential bar should be connected to the protective earth conductors in the ducts of the non GE cableways and to additional equipotential connections linking up all the conducting units in the rooms where GE units are located.

CABLES

- Power and cable installation must comply with the distribution diagram below.
- All cables must be isolated and flexible.
- Cable color codes must comply with standards for electrical installation.

Case MDP furnished by GE : The cables for signals and remote control (SEO, XRL1...) will go to MDP with a pigtail length of 1.5 m (4.9 ft), and will be connected during installation. Each conductor will be identified and isolated (screw connector).

CABLEWAYS

The general rules for laying cableways should meet the conditions laid down in current standards and regulations, with regard to:

- Protecting cables against water (cableways should be waterproof)
- Protecting cables against abnormal temperatures (proximity to heating pipes or ducts)
- Protecting cables against temperature shocks
- Replacing cables (cableways should be large enough for cables to be replaced) metal cableways should be grounded.

FEEDER TABLE

MIN. FEEDER WIRE SIZE, AWG OR MCM (sq. mm)/VAC	MINIMUM FEEDER WIRE LENGTH - ft (m)								
	50 (15)	100 (30)	150 (46)	200 (61)	250 (76)	300 (91)	350 (107)	400 (122)	450 (137)
480 VAC	2 (34)	2 (34)	2 (34)	1 (45)	1/0 (54)	2/0 (68)	3/0 (85)	3/0 (85)	4/0 (107)
GENERAL NOTES									
In all cases qualified personnel must verify that the feeder (at the point of take-off) and the run to the GE system meet all the requirements stated in the PIM									
For a single unit installation, the minimum transformer size is 150 kVA, Synthesized power feed is not acceptable									
Grounding conductor will be of the same size as the feeder. This ground will run from the equipment back to the power source/main grounding point and always travel in the same conduit with the feeders									

POWER DISTRIBUTION

