

Technical Publications

Direction 2256472-100
Revision 4

EchoPAC version 6.3.2 **CONFORMANCE STATEMENT** **for DICOM V3.0**

Copyright © 2000 By General Electric Co.

Do not duplicate

g

GE Vingmed Ultrasound

GE MEDICAL SYSTEMS
DIRECTION 2256472-100 REV 4

ECHOPAC 6.3.2
CONFORMANCE STATEMENT

THIS PAGE LEFT INTENTIONALLY BLANK

TABLE OF CONTENTS

1. INTRODUCTION	1
1.1 OVERVIEW	1
1.2 OVERALL DICOM CONFORMANCE STATEMENT DOCUMENT STRUCTURE	2
1.3 INTENDED AUDIENCE.....	3
1.4 SCOPE AND FIELD OF APPLICATION	4
1.5 IMPORTANT REMARKS	4
1.6 REFERENCES.....	5
1.7 DEFINITIONS.....	5
1.8 SYMBOLS AND ABBREVIATIONS.....	5
2. NETWORK CONFORMANCE STATEMENT	6
2.1 INTRODUCTION.....	6
2.2 IMPLEMENTATION MODEL	6
2.2.1 Application Data Flow Diagram	6
2.2.2 Functional Definition of AE's	8
2.2.3 Sequencing of Real-World Activities.....	8
2.3 AE SPECIFICATIONS	9
2.3.1 EchoPAC AE Specification	9
2.4 COMMUNICATION PROFILES.....	23
2.4.1 Supported Communication Stacks (PS 3.8, PS 3.9).....	23
2.4.2 OSI Stack.....	23
2.4.3 TCP/IP Stack.....	23
2.4.4 Point-to-Point Stack.....	23
2.5 EXTENSIONS / SPECIALIZATIONS / PRIVATIZATIONS.....	23
2.6 CONFIGURATION.....	24
2.6.1 AE Title/Presentation Address Mapping.....	24
2.6.2 Configurable Parameters.....	24
2.7 SUPPORT OF EXTENDED CHARACTER SETS.....	26
3. MEDIA STORAGE CONFORMANCE STATEMENT	27

3.1 INTRODUCTION.....27

3.2 IMPLEMENTATION MODEL27

 3.2.1 Application Data Flow Diagram27

 3.2.2 Functional Definition of AE’s28

 3.2.3 Sequencing Requirements28

 3.2.4 File Meta Information Options (See PS3.10).....28

3.3 AE SPECIFICATIONS28

 3.3.1 EchoPAC AE Specification28

3.4 AUGMENTED AND PRIVATE APPLICATION PROFILES33

3.5 EXTENSIONS, SPECIALIZATIONS, PRIVATIZATIONS OF SOP CLASSES AND TRANSFER SYNTAXES.....33

3.6 CONFIGURATION.....33

3.7 SUPPORT OF EXTENDED CHARACTER SETS.....34

4. ULTRASOUND (US) INFORMATION OBJECT IMPLEMENTATION..... 35

4.1 INTRODUCTION.....35

4.2 US IOD IMPLEMENTATION35

4.3 US ENTITY-RELATIONSHIP MODEL.....35

 4.3.1 Entity Descriptions.....36

 4.3.2 EchoPAC Mapping of DICOM Entities36

4.4 IOD MODULE TABLE.....37

4.5 INFORMATION MODULE DEFINITIONS37

 4.5.1 Common Patient Entity Modules38

 4.5.2 Common Study Entity Modules39

 4.5.3 Common Series Entity Modules40

 4.5.4 Common Equipment Entity Modules.....41

 4.5.5 Common Image Entity Modules41

 4.5.6 General Modules46

 4.5.7 US Modules46

5. ULTRASOUND MULTIFRAME (US MF) INFORMATION OBJECT IMPLEMENTATION 52

5.1 INTRODUCTION.....52

5.2 US IOD IMPLEMENTATION52

5.3 US ENTITY-RELATIONSHIP MODEL.....52

 5.3.1 Entity Descriptions.....53

 5.3.2 EchoPAC Mapping of DICOM entities.....53

5.4 IOD MODULE TABLE.....54

5.5 INFORMATION MODULE DEFINITIONS55

5.5.1 Common Image Modules.....55

6. SC INFORMATION OBJECT IMPLEMENTATION..... 58

6.1 INTRODUCTION.....58

6.2 SC IOD IMPLEMENTATION58

6.3 SC ENTITY-RELATIONSHIP MODEL58

6.3.1 Entity Descriptions.....59

6.3.2 EchoPAC Mapping of DICOM Entities59

6.4 IOD MODULE TABLE.....60

6.5 INFORMATION MODULE DEFINITIONS60

6.5.1 SC Modules61

7. BASIC DIRECTORY INFORMATION OBJECT IMPLEMENTATION 62

7.1 INTRODUCTION.....62

7.2 BASIC DIRECTORY IOD IMPLEMENTATION62

7.3 BASIC DIRECTORY ENTITY-RELATIONSHIP MODEL.....62

7.3.1 EchoPAC Mapping of DICOM entities.....62

7.4 IOD MODULE TABLE.....63

7.5 INFORMATION MODULE DEFINITIONS64

7.5.1 Common File Set identification Modules.....64

7.5.2 Common Directory Information Modules64

7.5.3 Definition of Specific Directory Records.....66

7.6 PRIVATE DATA DICTIONARY.....69

8. PRINT MANAGEMENT SOP CLASS DEFINITION..... 70

8.1 INTRODUCTION.....70

8.2 BASIC PRINT MANAGEMENT META SOP CLASSES70

8.2.1 Basic Grayscale Print Management Meta SOP Class.....70

8.2.2 Basic Color Print Management Meta SOP Class70

8.3 PRINT MANAGEMENT SOP CLASS DEFINITIONS71

8.3.1 Basic Film Session SOP Class.....71

8.3.2 Basic Film Box SOP Class72

8.3.3 Image Box SOP Class.....72

8.3.4 Printer SOP Class73

8.4 PRINT MANAGEMENT IODS73

8.4.1 Film Session IOD Module74

8.4.2 Basic Film Box IOD Module Table.....74

8.4.3	Basic Image Box IOD Module Table.....	74
8.4.4	Printer IOD Module Table	74
8.5	INFORMATION MODULE DEFINITIONS	74
8.5.1	General Modules	75
8.5.2	Print Management Modules	75
9.	MODALITY WORKLIST INFORMATION MODEL DEFINITION.....	81
9.1	INTRODUCTION.....	81
9.2	MODALITY WORKLIST INFORMATION MODEL DESCRIPTION.....	81
9.3	MODALITY WORKLIST INFORMATION MODEL ENTITY-RELATIONSHIP MODEL	81
9.3.1	Entity Descriptions.....	82
9.3.2	EchoPAC Mapping of DICOM entities.....	83
9.4	INFORMATION MODEL MODULE TABLE.....	83
9.5	INFORMATION MODEL KEYS	84
9.5.1	Supported Matching	84
9.5.2	Scheduled Procedure Step Entity.....	84
9.5.3	Requested Procedure Entity	86
9.5.4	Imaging Service Request Entity	87
9.5.5	Visit Entity	87
9.5.6	Patient Entity.....	88
10.	MODALITY PERFORMED PROCEDURE STEP SOP CLASS DEFINITION	91
10.1	INTRODUCTION.....	91
10.2	MODALITY PERFORMED PROCEDURE STEP SOP CLASS DEFINITION	91
10.2.1	IOD Description.....	91
10.2.2	Operations	94
11.	STORAGE COMMITMENT PUSH MODEL SOP CLASS DEFINITION	98
11.1	INTRODUCTION.....	98
11.2	STORAGE COMMITMENT PUSH MODEL SOP CLASS DEFINITION	98
11.2.1	IOD Description.....	98
11.2.2	DIMSE Service Group.....	99
11.2.3	Operations	99
11.2.4	Notifications.....	102

1. INTRODUCTION

1.1 OVERVIEW

This DICOM Conformance Statement is divided into Sections as described below:

Section 1 (Introduction), which describes the overall structure, intent, and references for this Conformance Statement

Section 2 (Network Conformance Statement), which specifies the GEMS equipment compliance to the DICOM requirements for the implementation of Networking features.

Section 3 (Media Storage Conformance Statement), which specifies the GEMS equipment compliance to the DICOM requirements for the implementation of Media Storage features.

Section 4 (Ultrasound Information Object Implementation), which specifies the GEMS equipment compliance to DICOM requirements for the implementation of an Ultrasound Medicine Information Object.

Section 5 (Ultrasound Multi-Frame Information Object Implementation), which specifies the GEMS equipment compliance to DICOM requirements for the implementation of an Ultrasound Multi-Frame Information.

Section 6 (SC Object Implementation), which specifies GEMS compliance to DICOM requirements for the implementation of a Secondary Capture Information Object.

Section 7 (Basic Directory Information Object Implementation), which specifies GEMS compliance to DICOM requirements for the implementation of a Basic Directory Information Object.

Section 8 (Basic Print Meta SOP Class Information Object Implementation), which specifies the GEMS equipment compliance to DICOM requirements for the implementation of Basic Print Meta SOP Classes (Gray and Color).

Section 9 (Modality Worklist Information Model), which specifies the GEMS equipment compliance to DICOM requirements for the implementation of the Modality Worklist service.

Section 10 (Modality Performed Procedure Step SOP Class Definition), which specifies the GEMS equipment compliance to DICOM requirements for the implementation of Modality Performed Procedure Step SOP Class Definition.

Section 11 (Storage Commitment Push Model SOP Class Definition), which specifies the GEMS equipment compliance to DICOM requirements for the implementation of the Storage Commitment Push Model SOP Class Definition.

1.2 OVERALL DICOM CONFORMANCE STATEMENT DOCUMENT STRUCTURE

The Documentation Structure of the GEMS Conformance Statements and their relationship with the DICOM v3.0 Conformance Statements is shown in the Illustration below.

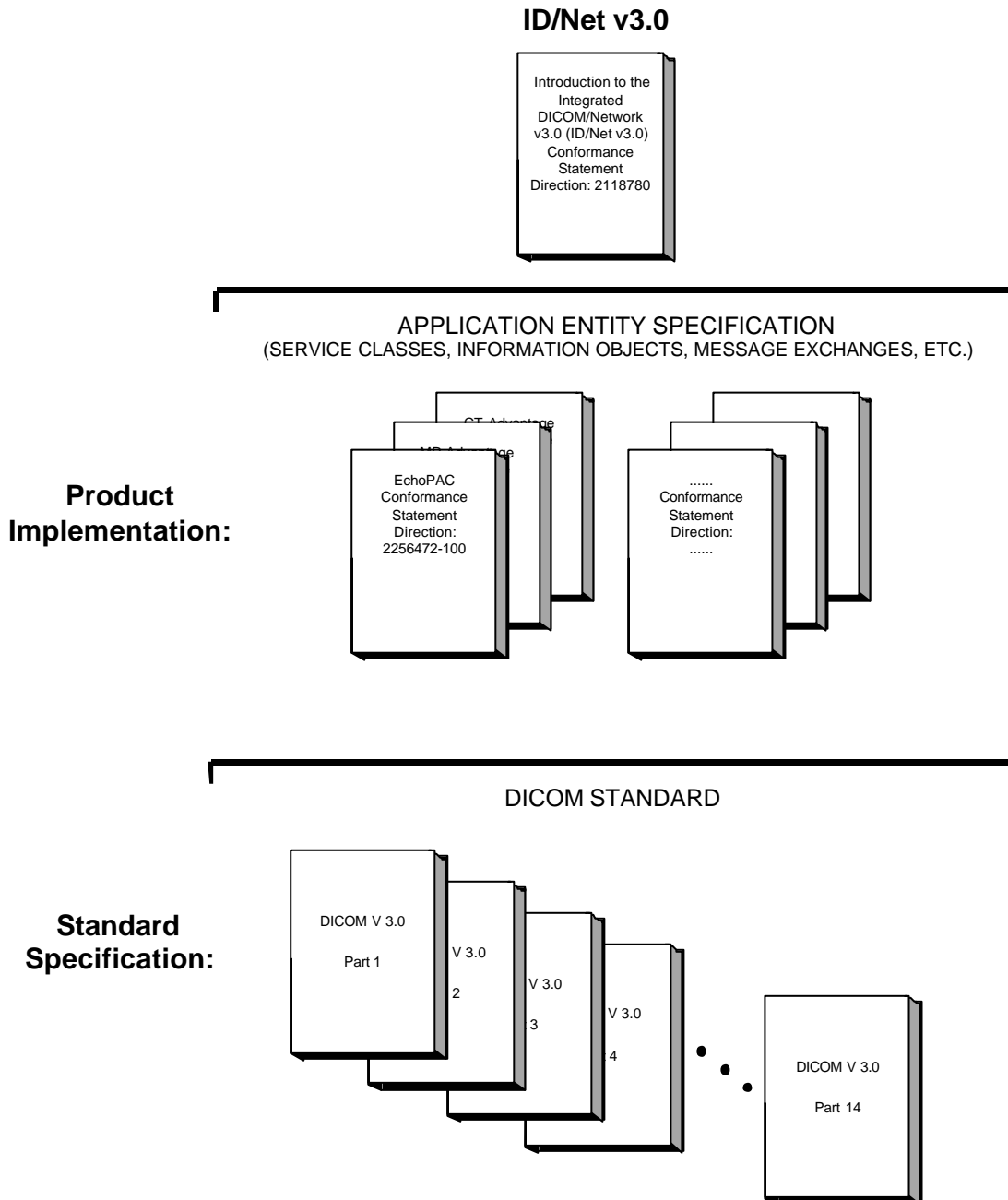

This document specifies the DICOM v3.0 implementation. It is entitled:

*EchoPAC version 6.3.2
Conformance Statement for DICOM v3.0
Direction 2256472-100*

This DICOM Conformance Statement documents the DICOM v3.0 Conformance Statement and Technical Specification required to inter-operate with the GEMS network interface. Introductory information, which is applicable to all GEMS Conformance Statements, is described in the document:

*Introduction to the Integrated DICOM/Network v3.0 (ID/Net v3.0)
Conformance Statement
Direction: 2118780.*

This Introduction familiarizes the reader with DICOM terminology and general concepts. It should be read prior to reading the individual products' GEMS Conformance Statements.

The GEMS Conformance Statement, contained in this document, also specifies the Lower Layer communications which it supports (e.g., TCP/IP). However, the Technical Specifications are defined in the DICOM v3.0 Part 8 standard.

For more information including Network Architecture and basic DICOM concepts, please refer to the Introduction.

For the convenience of software developers, there is "collector" Direction available. By ordering the collector, the Introduction described above and all of the currently published GEMS Product Conformance Statements will be received. The collector Direction is:

*ID/Net v3.0 Conformance Statements
Direction: 2117016*

For more information regarding DICOM v3.0, copies of the Standard may be obtained by written request or phone by contacting:

NEMA Publication
1300 North 17th Street
Suite 1847
Rosslyn, VA 22209
USA
Phone: (703) 841-3200

1.3 INTENDED AUDIENCE

The reader of this document is concerned with software design and/or system integration issues. It is assumed that the reader of this document is familiar with the DICOM v3.0 Standards and with the terminology and concepts, which are used in those Standards.

If readers are unfamiliar with DICOM v3.0 terminology they should first refer to the document listed below, then read the DICOM v3.0 Standard itself, prior to reading this DICOM Conformance Statement document.

*Introduction to the Integrated DICOM/Network v3.0 (ID/Net v3.0)
Conformance Statement*

Direction: 2118780

1.4 SCOPE AND FIELD OF APPLICATION

It is the intent of this document, in conjunction with the *Introduction to the Integrated DICOM/Network v3.0 (ID/Net v3.0) Conformance Statement, Direction: 2118780*, to provide an unambiguous specification for GEMS implementations. This specification, called a Conformance Statement, includes a DICOM v3.0 Conformance Statement and is necessary to ensure proper processing and interpretation of GEMS medical data exchanged using DICOM v3.0. The GEMS Conformance Statements are available to the public.

The reader of this DICOM Conformance Statement should be aware that different GEMS devices are capable of using different Information Object Definitions. For example, a GEMS CT Scanner may send images using the CT Information Object, MR Information Object, Secondary Capture Object, etc.

Included in this DICOM Conformance Statement are the Module Definitions, which define all data elements, used by this GEMS implementation. If the user encounters unspecified private data elements while parsing a GEMS Data Set, the user is well advised to ignore those data elements (per the DICOM v3.0 standard). Unspecified private data element information is subject to change without notice. If, however, the device is acting as a "full fidelity storage device", it should retain and re-transmit all of the private data elements which are sent by GEMS devices.

1.5 IMPORTANT REMARKS

The use of these DICOM Conformance Statements, in conjunction with the DICOM v3.0 Standards, is intended to facilitate communication with GE imaging equipment. However, **by itself, it is not sufficient to ensure that inter-operation will be successful**. The **user (or user's agent)** needs to proceed with caution and address at least four issues:

- **Integration** - The integration of any device into an overall system of interconnected devices goes beyond the scope of standards (DICOM v3.0), and of this introduction and associated DICOM Conformance Statements when interoperability with non-GE equipment is desired. The responsibility to analyze the applications requirements and to design a solution that integrates GE imaging equipment with non-GE systems is the **user's** responsibility and should not be underestimated. The **user** is strongly advised to ensure that such an integration analysis is correctly performed.
- **Validation** - Testing the complete range of possible interactions between any GE device and non-GE devices, before the connection is declared operational, should not be overlooked. Therefore, the **user** should ensure that any non-GE provider accepts full responsibility for all validation required for their connection with GE devices. This includes the accuracy of the image data once it has crossed the interface between the GE imaging equipment and the non-GE device and the stability of the image data for the intended applications.
- Such a validation is required before any clinical use (diagnosis and/or treatment) is performed. It applies when images acquired on GE imaging equipment are processed/displayed on a non-GE device, as well as when images acquired on non-GE equipment is processed/displayed on a GE console or workstation.
- **Future Evolution** - GE understands that the DICOM Standard will evolve to meet the user's growing requirements. GE is actively involved in the development of the DICOM v3.0 Standard. DICOM v3.0 will incorporate new features and technologies and GE may follow the evolution of the Standard. The GEMS protocol is based on DICOM v3.0 as specified in each DICOM Conformance Statement. Evolution of the Standard may require changes to devices, which have implemented DICOM v3.0. **In addition, GE reserves the right to discontinue or make changes to the support of communications features (on its products) reflected on by these DICOM Conformance Statements.** The **user** should ensure that any non-GE provider, which connects with GE devices, also plans for the future evolution of the DICOM Standard. Failure to do so will likely result in the loss of function and/or connectivity as the DICOM Standard changes and GE Products are enhanced to support these changes.
- **To be informed of the evolution of the implementation described in this document, the User is advised to regularly check the GE Internet Server, accessible via anonymous ftp (GE Internet Server Address: ftp.med.ge.com, 192.88.230.11).**
- **Interaction** - It is the sole responsibility of the **non-GE provider** to ensure that communication with the interfaced equipment does not cause degradation of GE imaging equipment performance and/or function.

1.6 REFERENCES

A list of references, which is applicable to all GEMS Conformance Statements, is included in the *Introduction to the Integrated DICOM/Network v3.0 (ID/Net v3.0) Conformance Statement, Direction: 2118780*.

The information object implementation refers to DICOM PS 3.3 (Information Object Definition).

1.7 DEFINITIONS

A set of definitions, which is applicable to all GEMS Conformance Statements, is included in *the Introduction to the Integrated DICOM/Network v3.0 (ID/Net v3.0) Conformance Statement, Direction: 2118780*.

1.8 SYMBOLS AND ABBREVIATIONS

A list of symbols and abbreviations, which is applicable to all GEMS Conformance Statements, is included in the *Introduction to the Integrated DICOM/Network v3.0 (ID/Net v3.0) Conformance Statement, Direction: 2118780*.

2. NETWORK CONFORMANCE STATEMENT

2.1 INTRODUCTION

This section of the DICOM Conformance Statement specifies the compliance to DICOM conformance requirements for the relevant **Networking** features for EchoPAC 6.3.2. Note that the format of this section strictly follows the format defined in DICOM Standard PS 3.2 (Conformance). Please refer to that part of the standard while reading this section.

2.2 IMPLEMENTATION MODEL

2.2.1 Application Data Flow Diagram

The Basic and Specific Application models for this device are shown in the following illustration:

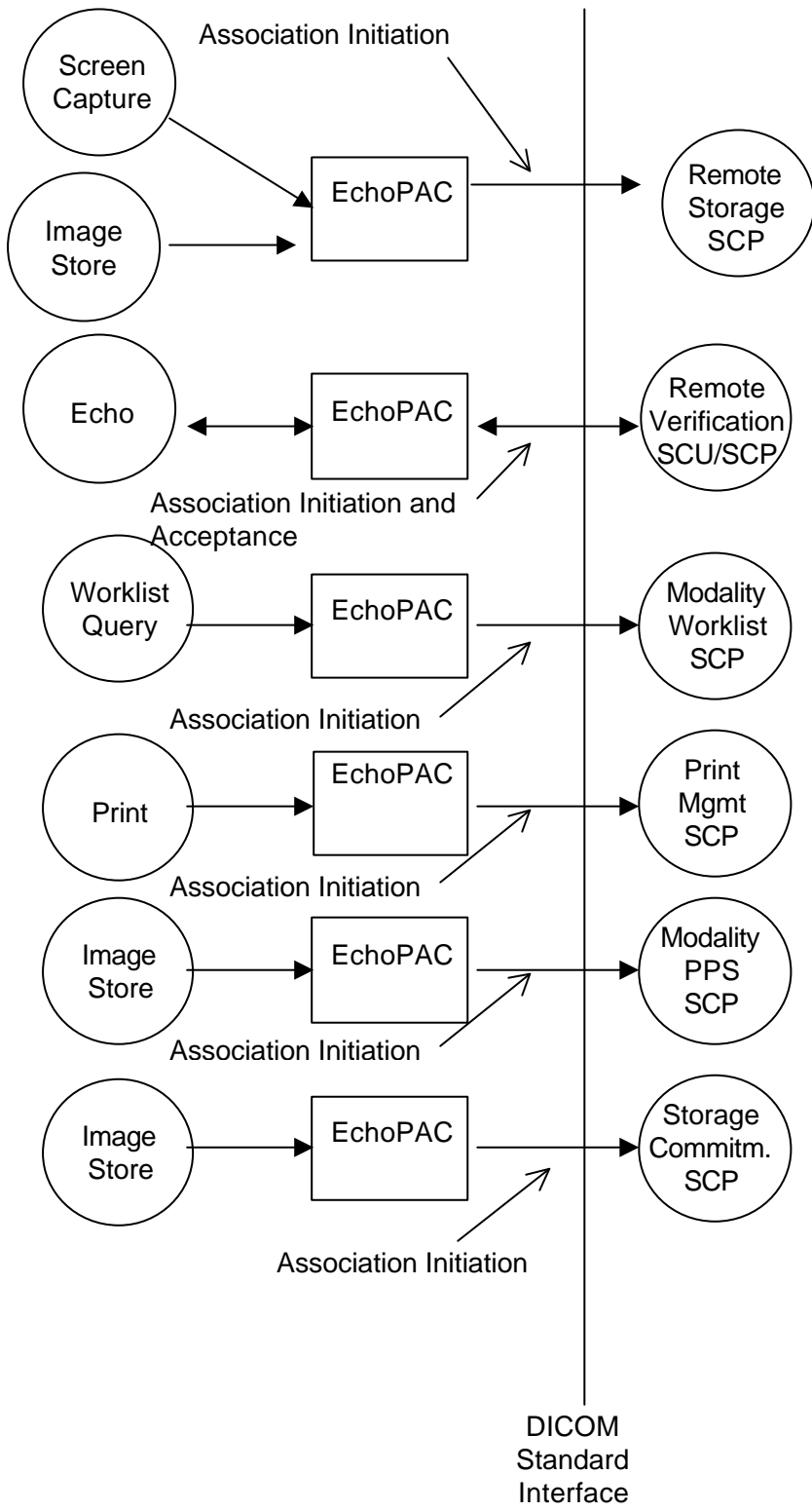

There are five local real-world activities that occur in EchoPAC - **Image Store, Screen Capture, Echo, Worklist Query and Print.**

Image Store initiates a connection with the server, encodes one or more images and transmits the images to the server. If Modality Performed Procedure Step is configured, EchoPAC will send start and end exam messages. If Storage Commitment is configured and EchoPAC is not in DICOM mode, EchoPAC will send commitment request message and respond to answer from the server. Image Store is activated either pressing **Export** in Patient Home Screen, pressing **Send patients** in DICOM buffer or pressing **DICOM** in the View Images or View Buffer. If an error occurs during transmission the storage is terminated and an error message is posted to the user.

Screen Capture initiates a connection with the server, encodes a DICOM image and transmits the images to the server. **Screen Capture** is activated pressing the Secondary Captured short-cut key. **Screen Capture** will only be activated if DICOM Storage SCP is selected as the target. If an error occurs during transmission the storage is terminated.

Echo initiates a connection with the DICOM server, posts an Echo message and closes the connection. Echo also responds to **Echo** messages from an SCU.

Worklist Query sends a query to a Worklist server with the search criteria entered in Worklist Screen.

Print will send images from the print buffer to a DICOM Print server.

2.2.2 Functional Definition of AE's

Application Entity EchoPAC supports the following functions:

- Initiates a DICOM association to send images.
- Encodes raw data images into DICOM images or load DICOM images from disk.
- Transmits DICOM images to the DICOM Storage SCP.
- Initiates a DICOM verification to assist in network diagnostics.
- Responds to DICOM verification requests from other devices.
- Initiates a DICOM worklist query to receive worklist info.
- Initiates a DICOM association to print images.
- Initiates a DICOM association to notify start of examination.
- Initiates a DICOM association to notify end of examination.
- Initiates a DICOM association to request storage commitment of images and responds to answer from server.

2.2.3 Sequencing of Real-World Activities

Image Store:

- EchoPAC initiates a DICOM association with the selected archive device AE when the operator requests an image to be sent. The initial association negotiation list depends on the configuration setting. The association negotiation lists are described in 2.3.1.2.1.2.
- The images are then transferred to the Storage SCP (DICOM servers) using the C-STORE command. Multiple images are sent on the same DICOM Association according to the configuration of the connection in the Config Setup. For example, if the images are within one series and the reopening setting is series, study, patient or session, then all images are sent

on the same connection. If the reopening setting is image, then the connection is reopened between sending every image. In DICOM mode, reopening is not in effect.

- If the export is successful and Modality Performed Procedure Step in configured, EchoPAC will send the following Modality Performed Procedure Step messages: NCREATE, N-SET with list of all exported (except imported DICOM images and Secondary Captures) images and an N-SET with the status COMPLETED.
- If the export is successful, Storage commitment is configured and EchoPAC is not in DICOM mode, EchoPAC will send the Storage Commitment message NACTION-RQ for all images in the export (except imported DICOM images and Secondary Captures). EchoPAC will then listen for NEVENT-REPORT-RQ from the Storage commitment server and update the status of the sent commitment request.

Screen Capture:

- EchoPAC initiates a DICOM association with the selected archive device AE when the operator requests an image to be sent. The initial association list depends on the configuration setting. The association negotiation list is described in 2.3.1.2.1.2.
- The images are then transferred to the server using the C-STORE command.

Echo:

An **Echo** is initiated in the Config Screen using the "Echo" button.

- The AE uses the C-ECHO to verify the communication path to a remote AE.

Echo also responds to Echo messages from an SCU.

- Upon a DICOM association with a Verify message, Echo will respond to the client.

Worklist Query:

- EchoPAC initiates a DICOM association to one specific SCP, using the C-FIND command to query and retrieve the worklist information.

Print:

- EchoPAC’s AE initiates a DICOM association with the selected printer AE when the operator presses the button for sending a print job to the printer.
- The AE uses the N-GET to retrieve an instance of the Printer SOP Class.
- The AE uses the N-CREATE to create a Basic Film Session SOP Instance.
- The AE uses the N-CREATE to create a Basic Film Box SOP Instance.
- The AE uses the N-SET to update the Basic Image Box IOD.
- The AE uses the N-ACTION (PRINT, Film Session Sop Instance) command to print the image.
- The AE uses the N-DELETE to delete the Film Box SOP Instance.

2.3 AESPECIFICATIONS

2.3.1 EchoPAC AE Specification

This Application Entity provides Standard Conformance to the following DICOM V3.0 SOP Classes as an **SCU**:

SOP Class Name	SOP Class UID
Ultrasound Multi-frame Image Storage	1.2.840.10008.5.1.4.1.1.3.1

Ultrasound Multi-frame Image Storage (Retired)	1.2.840.10008.5.1.4.1.1.3
Ultrasound Image Storage	1.2.840.10008.5.1.4.1.1.6.1
Ultrasound Image Storage (Retired)	1.2.840.10008.5.1.4.1.1.6
Secondary Capture Image Storage	1.2.840.10008.5.1.4.1.1.7
Verification SOP Class	1.2.840.10008.1.1
Basic Grayscale Print Management Meta SOP Class	1.2.840.10008.5.1.1.9
Basic Color Print Management Meta SOP Class	1.2.840.10008.5.1.1.18
Modality Worklist Information Model - FIND	1.2.840.10008.5.1.4.31
Modality Performed Procedure Step SOP Class	1.2.840.10008.3.1.2.3.3
Storage Commitment Push Model SOP Class	1.2.840.10008.1.20.1

This Application Entity provides Standard Conformance to the following DICOM V3.0 SOP Classes as an **SCP**:

SOP Class Name	SOP Class UID
Verification SOP Class	1.2.840.10008.1.1

2.3.1.1 Association Establishment Policies

2.3.1.1.1 General

The DICOM Application Context Name (ACN), which is always proposed, is:

Application Context Name	1.2.840.10008.3.1.1.1
---------------------------------	------------------------------

The Maximum Length PDU negotiation is included in all association establishment requests.

The maximum length PDU for an association initiated by EchoPAC is configurable.

Maximum Length PDU	Configurable from 4096 to 30000
---------------------------	--

The SOP Class Extended Negotiation is not supported.

The user information Items sent by this product are:

- Maximum PDU Length
- Implementation UID
- Implementation Version Name

2.3.1.1.2 Number of Associations

The EchoPAC AE will initiate only one DICOM association at a time to perform an image store, or verify.

The EchoPAC AE can have a maximum of two DICOM associations open simultaneously, one to send an image and one to respond to an Echo or Storage Commitment result.

2.3.1.1.3 Asynchronous Nature

Asynchronous mode is not supported. All operations will be performed synchronously.

2.3.1.1.4 Implementation Identifying Information

The Implementation UID for this DICOM v3.0 Implementation is:

EchoPAC Implementation UID	1.2.840.113619.6.71
-----------------------------------	----------------------------

The Implementation Version Name for this DICOM v3.0 Implementation is:

EchoPAC Implementation Version Name	EchoPAC_6_3_2
--	----------------------

Note: The Implementation Version Name and may change in the future without modification of this document.

2.3.1.2 Association Initiation Policy

The EchoPAC AE attempts to establish a new association with a remote device due to five Real-World Activities:

- Image Store initiated by the operator for a specific image or group of images.
- Screen Capture initiated by the operator for a specific image or group of images.
- Verification, which verifies application level communication between peer DICOM AE's for service purposes.
- Worklist initiated by the operator for receiving worklist info.
- Print initiated by the operator for a specific image or group of images.

2.3.1.2.1 Real-World Activity A (‘Image Store’ Operation)**2.3.1.2.1.1 Associated Real-World Activity**

Upon a request by the operator, images will be sent to a DICOM Storage SCP. If an error occurs during the transmission, the current association is released and a new association initiated. The maximum number of retries is configurable.

2.3.1.2.1.2 Proposed Presentation Context Tables

The proposed transfer syntaxes depend on the configuration settings for reopening the connection if compression is not “Default”, in which case all syntaxes are proposed.

If the reopening setting is equal to **session, patient or study**, the most advanced negotiation scheme is used. Then the connection is negotiated to allow for transfer of image objects using of different transfer syntaxes without reopening the connection to the Storage SCP. This means that images encoded with different compression schemes may be transmitted without reopening the connection. Not all Storage SCP devices handles this association policy properly, and verification of image handling is necessary before using this setting.

If the **Reopen Transmission** is equal to **series**, the negotiation list contains only one instance of every SOP class UID, and the objects are negotiated using one compression setting. This means that images encoded using different SOP class UIDs (Secondary Captured, Ultrasound, Ultrasound MF) may be transmitted without reopening the Storage SCP connection, as long as the images are encoded using the same compression (uncompressed, RLE or JPEG) and the images are within one series. This association policy is normally supported by the Storage SCP devices.

If the reopening setting is equal to **image**, only one SOP class UID and one image compression scheme is negotiated. In this case the Storage SCP connection is reopened between sending every images. This association policy may be used if the communication with the Storage SCP device is problematic using **Reopen Transmission** equal to **series**.

2.3.1.2.1.2.1 Reopen Transmission: session, patient or study

The Proposed Presentation Context Table used when the **Reopen Transmission** is set to session, patient or study is:

Presentation Context Table 1 - Proposed					
Abstract Syntax		Transfer Syntax		Role	Extended Negotiation
Name	UID	Name List	UID List		
Secondary Capture Image Storage	1.2.840.10008.5.1.4.1.1.7	Explicit VR Little Endian	1.2.840.10008.1.2.1	SCU	None
		Explicit VR Big Endian	1.2.840.10008.1.2.2		
		Implicit VR Little Endian	1.2.840.10008.1.2		
Secondary Capture Image Storage	1.2.840.10008.5.1.4.1.1.7	Run Length Encoding, RLE	1.2.840.10008.1.2.5	SCU	None
Secondary Capture Image Storage	1.2.840.10008.5.1.4.1.1.7	JPEG Baseline	1.2.840.10008.1.2.4.50	SCU	None
Ultrasound Image Storage	1.2.840.10008.5.1.4.1.1.6.1	Explicit VR Little Endian	1.2.840.10008.1.2.1	SCU	None
		Explicit VR Big Endian	1.2.840.10008.1.2.2		
		Implicit VR Little Endian	1.2.840.10008.1.2		
Ultrasound Image Storage	1.2.840.10008.5.1.4.1.1.6.1	Run Length Encoding, RLE	1.2.840.10008.1.2.5	SCU	None

Ultrasound Image Storage	1.2.840.10008.5.1.4.1.1.6.1	JPEG Baseline	1.2.840.10008.1.2.4.50	SCU	None
Ultrasound Multi-frame Image Storage	1.2.840.10008.5.1.4.1.1.3.1	Explicit VR Little Endian Explicit VR Big Endian Implicit VR Little Endian	1.2.840.10008.1.2.1 1.2.840.10008.1.2.2 1.2.840.10008.1.2	SCU	None
Ultrasound Multi-frame Image Storage	1.2.840.10008.5.1.4.1.1.3.1	Run Length Encoding, RLE	1.2.840.10008.1.2.5	SCU	None
Ultrasound Multi-frame Image Storage	1.2.840.10008.5.1.4.1.1.3.1	JPEG Baseline	1.2.840.10008.1.2.4.50	SCU	None
Ultrasound Image Storage (retired)	1.2.840.10008.5.1.4.1.1.6	Explicit VR Little Endian Explicit VR Big Endian Implicit VR Little Endian	1.2.840.10008.1.2.1 1.2.840.10008.1.2.2 1.2.840.10008.1.2	SCU	None
Ultrasound Image Storage (retired)	1.2.840.10008.5.1.4.1.1.6	Run Length Encoding, RLE	1.2.840.10008.1.2.5	SCU	None
Ultrasound Image Storage (retired)	1.2.840.10008.5.1.4.1.1.6	JPEG Baseline	1.2.840.10008.1.2.4.50	SCU	None
Ultrasound Multi-frame Image Storage (retired)	1.2.840.10008.5.1.4.1.1.3	Explicit VR Little Endian Explicit VR Big Endian Implicit VR Little Endian	1.2.840.10008.1.2.1 1.2.840.10008.1.2.2 1.2.840.10008.1.2	SCU	None
Ultrasound Multi-frame Image Storage (retired)	1.2.840.10008.5.1.4.1.1.3	Run Length Encoding, RLE	1.2.840.10008.1.2.5	SCU	None
Ultrasound Multi-frame Image Storage (retired)	1.2.840.10008.5.1.4.1.1.3	JPEG Baseline	1.2.840.10008.1.2.4.50	SCU	None

2.3.1.2.1.2.2 Reopen Transmission: series

When **Reopen Transmission** is set to **series**, there are three presentation context lists, one for every setting of Compression:

Presentation Context Table 2 – Proposed					
Abstract Syntax		Transfer Syntax		Role	Extended Negotiation
Name	UID	Name List	UID List		
Presentation Context Table: Compression set to None					
Secondary Capture Image Storage	1.2.840.10008.5.1.4.1.1.7	Explicit VR Little Endian Explicit VR Big Endian Implicit VR Little Endian	1.2.840.10008.1.2.1 1.2.840.10008.1.2.2 1.2.840.10008.1.2	SCU	None
Ultrasound Image Storage	1.2.840.10008.5.1.4.1.1.6.1	Explicit VR Little Endian Explicit VR Big Endian Implicit VR Little Endian	1.2.840.10008.1.2.1 1.2.840.10008.1.2.2 1.2.840.10008.1.2	SCU	None
Ultrasound Multi-frame Image Storage	1.2.840.10008.5.1.4.1.1.3.1	Explicit VR Little Endian Explicit VR Big Endian Implicit VR Little Endian	1.2.840.10008.1.2.1 1.2.840.10008.1.2.2 1.2.840.10008.1.2	SCU	None
Ultrasound Image Storage	1.2.840.10008.5.1.4.1.1.6	Explicit VR Little Endian	1.2.840.10008.1.2.1	SCU	None

(retired)		Explicit VR Big Endian	1.2.840.10008.1.2.2		
		Implicit VR Little Endian	1.2.840.10008.1.2		
Ultrasound Multi-frame Image Storage(retired)	1.2.840.10008.5.1.4.1.1.3	Explicit VR Little Endian	1.2.840.10008.1.2.1	SCU	None
		Explicit VR Big Endian	1.2.840.10008.1.2.2		
		Implicit VR Little Endian	1.2.840.10008.1.2		
Presentation Context Table: Compression set to None 1S					
Secondary Capture Image Storage	1.2.840.10008.5.1.4.1.1.7	Implicit VR Little Endian	1.2.840.10008.1.2	SCU	None
Ultrasound Image Storage	1.2.840.10008.5.1.4.1.1.6.1	Implicit VR Little Endian	1.2.840.10008.1.2	SCU	None
Ultrasound Multi-frame Image Storage	1.2.840.10008.5.1.4.1.1.3.1	Implicit VR Little Endian	1.2.840.10008.1.2	SCU	None
Ultrasound Image Storage (retired)	1.2.840.10008.5.1.4.1.1.6	Implicit VR Little Endian	1.2.840.10008.1.2	SCU	None
Ultrasound Multi-frame Image Storage(retired)	1.2.840.10008.5.1.4.1.1.3	Implicit VR Little Endian	1.2.840.10008.1.2	SCU	None
Presentation Context Table: Compression set to RLE					
Secondary Capture Image Storage	1.2.840.10008.5.1.4.1.1.7	Run Length Encoding, RLE	1.2.840.10008.1.2.5	SCU	None
Ultrasound Image Storage	1.2.840.10008.5.1.4.1.1.6.1	Run Length Encoding, RLE	1.2.840.10008.1.2.5	SCU	None
Ultrasound Multi-frame Image Storage	1.2.840.10008.5.1.4.1.1.3.1	Run Length Encoding, RLE	1.2.840.10008.1.2.5	SCU	None
Ultrasound Image Storage (retired)	1.2.840.10008.5.1.4.1.1.6	Run Length Encoding, RLE	1.2.840.10008.1.2.5	SCU	None
Ultrasound Multi-frame Image Storage(retired)	1.2.840.10008.5.1.4.1.1.3	Run Length Encoding, RLE	1.2.840.10008.1.2.5	SCU	None
Presentation Context Table: Compression set to JPEG					
Secondary Capture Image Storage	1.2.840.10008.5.1.4.1.1.7	JPEG Baseline	1.2.840.10008.1.2.4.50	SCU	None
Ultrasound Image Storage	1.2.840.10008.5.1.4.1.1.6.1	JPEG Baseline	1.2.840.10008.1.2.4.50	SCU	None
Ultrasound Multi-frame Image Storage	1.2.840.10008.5.1.4.1.1.3.1	JPEG Baseline	1.2.840.10008.1.2.4.50	SCU	None

Ultrasound Image Storage	1.2.840.10008.5.1.4.1.1.6	JPEG Baseline	1.2.840.10008.1.2.4.50	SCU	None
Ultrasound Multi-frame Image Storage(retired)	1.2.840.10008.5.1.4.1.1.3	JPEG Baseline	1.2.840.10008.1.2.4.50	SCU	None

2.3.1.2.1.2.3 Reopening Transmission: image

When **Reopen Transmission** is set to image, only one of the Abstract syntaxes in the table is negotiated, and this Presentation Context Table depends on the Compression setting and the DICOM object to be transferred to the Storage SCP. The proposed Presentation Context Tables as a function of Compression and Storage service are:

Presentation Context Table 3 – Proposed					
Abstract Syntax		Transfer Syntax		Role	Extended Negotiation
Name	UID	Name List	UID List		
Presentation Context Table: Compression set to None, Secondary Captured Image Storage					
Secondary Capture Image Storage	1.2.840.10008.5.1.4.1.1.7	Explicit VR Little Endian	1.2.840.10008.1.2.1	SCU	None
		Explicit VR Big Endian			
		Implicit VR Little Endian	1.2.840.10008.1.2.2		
			1.2.840.10008.1.2		
Presentation Context Table: Compression set to None IS, Secondary Captured Image Storage					
Secondary Capture Image Storage	1.2.840.10008.5.1.4.1.1.7	Implicit VR Little Endian	1.2.840.10008.1.2	SCU	None
Presentation Context Table: Compression set to RLE, Secondary Captured Image Storage					
Secondary Capture Image Storage	1.2.840.10008.5.1.4.1.1.7	Run Length Encoding, RLE	1.2.840.10008.1.2.5	SCU	None
Presentation Context Table: Compression set to JPEG, Secondary Captured Image Storage					
Secondary Capture Image Storage	1.2.840.10008.5.1.4.1.1.7	JPEG Baseline	1.2.840.10008.1.2.4.50	SCU	None
Presentation Context Table: Compression set to None, Ultrasound Image Storage					
Ultrasound Image Storage	1.2.840.10008.5.1.4.1.1.6.1	Explicit VR Little Endian	1.2.840.10008.1.2.1	SCU	None
		Explicit VR Big Endian			
		Implicit VR Little Endian	1.2.840.10008.1.2.2		
			1.2.840.10008.1.2		

Presentation Context Table 3 – Proposed					
Presentation Context Table: Compression set to None 1S, Ultrasound Image Storage					
Ultrasound Image Storage	1.2.840.10008.5.1.4.1.1.6.1	Implicit VR Little Endian	1.2.840.10008.1.2	SCU	None
Presentation Context Table: Compression set to RLE, Ultrasound Image Storage					
Ultrasound Image Storage	1.2.840.10008.5.1.4.1.1.6.1	Run Length Encoding, RLE	1.2.840.10008.1.2.5	SCU	None
Presentation Context Table: Compression set to JPEG, Ultrasound Image Storage					
Ultrasound Image Storage	1.2.840.10008.5.1.4.1.1.6.1	JPEG Baseline	1.2.840.10008.1.2.4.50	SCU	None
Presentation Context Table: Compression set to None, Ultrasound Multi-frame Image Storage					
Ultrasound Multi-frame Image Storage	1.2.840.10008.5.1.4.1.1.3.1	Explicit VR Little Endian	1.2.840.10008.1.2.1	SCU	None
		Explicit VR Big Endian			
		Implicit VR Little Endian	1.2.840.10008.1.2.2 1.2.840.10008.1.2		
Presentation Context Table: Compression set to None 1S, Ultrasound Multi-frame Image Storage					
Ultrasound Multi-frame Image Storage	1.2.840.10008.5.1.4.1.1.3.1	Implicit VR Little Endian	1.2.840.10008.1.2	SCU	None
Presentation Context Table: Compression set to RLE, Ultrasound Multi-frame Image Storage					
Ultrasound Multi-frame Image Storage	1.2.840.10008.5.1.4.1.1.3.1	Run Length Encoding, RLE	1.2.840.10008.1.2.5	SCU	None
Presentation Context Table: Compression set to JPEG, Ultrasound Multi-frame Image Storage					
Ultrasound Multi-frame Image Storage	1.2.840.10008.5.1.4.1.1.3.1	JPEG Baseline	1.2.840.10008.1.2.4.50	SCU	None
Presentation Context Table: Compression set to None, Ultrasound Image Storage (retired)					
Ultrasound Image Storage (retired)	1.2.840.10008.5.1.4.1.1.6	Explicit VR Little Endian	1.2.840.10008.1.2.1	SCU	None
		Explicit VR Big Endian			
		Implicit VR Little Endian	1.2.840.10008.1.2.2 1.2.840.10008.1.2		

Presentation Context Table 3 – Proposed				
Presentation Context Table: Compression set to None 1S, Ultrasound Image Storage (retired)				
Ultrasound Image Storage (retired)	1.2.840.10008.5.1.4.1.1.6	Implicit VR Little Endian	1.2.840.10008.1.2	SCU None
Presentation Context Table: Compression set to RLE, Ultrasound Image Storage (retired)				
Ultrasound Image Storage (retired)	1.2.840.10008.5.1.4.1.1.6	Run Length Encoding, RLE	1.2.840.10008.1.2.5	SCU None
Presentation Context Table: Compression set to JPEG, Ultrasound Image Storage (retired)				
Ultrasound Image Storage (retired)	1.2.840.10008.5.1.4.1.1.6	JPEG Baseline	1.2.840.10008.1.2.4.50	SCU None
Presentation Context Table: Compression: None, Ultrasound Multi-frame Image Storage (retired)				
Ultrasound Multi-frame Image Storage (retired)	1.2.840.10008.5.1.4.1.1.3	Explicit VR Little Endian Explicit VR Big Endian Implicit VR Little Endian	1.2.840.10008.1.2.1 1.2.840.10008.1.2.2 1.2.840.10008.1.2	SCU None
Presentation Context Table: Compression: None 1S, Ultrasound Multi-frame Image Storage (retired)				
Ultrasound Multi-frame Image Storage (retired)	1.2.840.10008.5.1.4.1.1.3	Implicit VR Little Endian	1.2.840.10008.1.2	SCU None
Presentation Context Table: Compression set to RLE, Ultrasound Multi-frame Image Storage (retired)				
Ultrasound Multi-frame Image Storage (retired)	1.2.840.10008.5.1.4.1.1.3	Run Length Encoding, RLE	1.2.840.10008.1.2.5	SCU None
Presentation Context Table: Compression set to JPEG, Ultrasound Multi-frame Image Storage (retired)				
Ultrasound Multi-frame Image Storage (retired)	1.2.840.10008.5.1.4.1.1.3	JPEG Baseline	1.2.840.10008.1.2.4.50	SCU None

2.3.1.2.1.2.4 Compression “Default”

The Proposed Presentation Context Table used when compression is set to “Default” is :

Presentation Context Table 4 – Proposed			
Abstract Syntax	Transfer Syntax	Role	Extended

Name	UID	Name List	UID List		Negotiation
Secondary Capture Image Storage	1.2.840.10008.5.1.4.1.1.7	JPEG Baseline Explicit VR Little Endian Explicit VR Big Endian Run Length Encoding, RLE Implicit VR Little Endian	1.2.840.10008.1.2.4.50 1.2.840.10008.1.2.1 1.2.840.10008.1.2.2 1.2.840.10008.1.2.5 1.2.840.10008.1.2	SCU	None
Ultrasound Image Storage	1.2.840.10008.5.1.4.1.1.6.1	JPEG Baseline Explicit VR Little Endian Explicit VR Big Endian Run Length Encoding, RLE Implicit VR Little Endian	1.2.840.10008.1.2.4.50 1.2.840.10008.1.2.1 1.2.840.10008.1.2.2 1.2.840.10008.1.2.5 1.2.840.10008.1.2	SCU	None
Ultrasound Multi-frame Image Storage	1.2.840.10008.5.1.4.1.1.3.1	JPEG Baseline Explicit VR Little Endian Explicit VR Big Endian Run Length Encoding, RLE Implicit VR Little Endian	1.2.840.10008.1.2.4.50 1.2.840.10008.1.2.1 1.2.840.10008.1.2.2 1.2.840.10008.1.2.5 1.2.840.10008.1.2	SCU	None
Ultrasound Image Storage (retired)	1.2.840.10008.5.1.4.1.1.6	JPEG Baseline Explicit VR Little Endian Explicit VR Big Endian Run Length Encoding, RLE Implicit VR Little Endian	1.2.840.10008.1.2.4.50 1.2.840.10008.1.2.1 1.2.840.10008.1.2.2 1.2.840.10008.1.2.5 1.2.840.10008.1.2	SCU	None
Ultrasound Multi-frame Image Storage (retired)	1.2.840.10008.5.1.4.1.1.3	JPEG Baseline Explicit VR Little Endian Explicit VR Big Endian Run Length Encoding, RLE Implicit VR Little Endian	1.2.840.10008.1.2.4.50 1.2.840.10008.1.2.1 1.2.840.10008.1.2.2 1.2.840.10008.1.2.5 1.2.840.10008.1.2	SCU	None

2.3.1.2.1.2.5 SOP Specific DICOM Conformance Statement for all Storage SOP Classes

Following are the status codes that are more specifically processed when receiving storage status messages from a **Storage SCP** equipment:

Service Status	Status Codes	Further Meaning	Application Behavior When receiving Status Codes	Related Fields Processed if received
Refused	A7xx	Out of resources	association is terminated; image not transferred	(0000,0902)
	0122	SOP Class not Supported	association is terminated; image not transferred	(0000,0902)
Error	Cxx	Cannot Understand	association is terminated; image not transferred	(0000,0901) (0000,0902)
	A9xx	Data Set does not match SOP Class	association is terminated; image not transferred	(0000,0901) (0000,0902)
Warning	B000	Coercion of Data Elements	treated as a 'Successful' response	(0000,0901) (0000,0902)
	B007	Data Set does not match SOP Class	treated as a 'Successful' response	(0000,0901) (0000,0902)
	B006	Elements Discarded	treated as a 'Successful' response	(0000,0901) (0000,0902)
Success	0000			None

The status codes are logged in the mergecom.log file if debugging is activated in the Config screen.

An association is open until an explicit reopen is select in the Config screen.

This operation also sends Modality Performed Procedure Step messages (if it is configured), with the following as the proposed presentation context.

Presentation Context Table– Proposed					
Abstract Syntax		Transfer Syntax		Role	Extended Negotiation
Name	UID	Name List	UID List		
Basic Worklist Management SOP Class	1.2.840.10008.5.1.4.31	Explicit VR Big Endian	1.2.840.10008.1.2.2	SCU	None
		Explicit VR Little Endian	1.2.840.10008.1.2.1		
		Implicit VR Little Endian	1.2.840.10008.1.2		
Modality Performed Procedure Step SOP Class	1.2.840.10008.3.1.2.3.3	Explicit VR Big Endian	1.2.840.10008.1.2.2	SCU	None
		Explicit VR Little Endian	1.2.840.10008.1.2.1		
		Implicit VR Little Endian	1.2.840.10008.1.2		

This operation also sends a Storage Commitment Request (if it is configured and EchoPAC is not in DICOM mode), with the following as the proposed presentation context.

Presentation Context Table - Proposed					
Abstract Syntax		Transfer Syntax		Role	Extended Negotiation
Name	UID	Name List	UID List		
Storage Commitment Push Model	1.2.840.10008.1.20.1	Explicit VR Big Endian	1.2.840.10008.1.2.2	SCU	None
		Explicit VR Little Endian	1.2.840.10008.1.2.1		
		Implicit VR Little Endian	1.2.840.10008.1.2		

2.3.1.2.2 Real-World Activity B ('Screen Capture' Operation)

Screen Capture is initiated through the DICOM screen capture shortcut. This activity is like 'Image Store', but only one image is sent, and this image is a single frame image.

2.3.1.2.3 Real-World Activity C ('Echo' Operation)

2.3.1.2.3.1 Associated Real-World Activity

The user may initiate a DICOM Verification Request in the Config screen by selecting one device to verify and pressing "Echo". The result of the C-ECHO is displayed on the screen.

Associations will be released upon the receipt of each C-ECHO confirmation.

2.3.1.2.3.2 Proposed Presentation Context Table

Presentation Context Table - Proposed					
Abstract Syntax		Transfer Syntax		Role	Extended Negotiation
Name	UID	Name List	UID List		
Verification SOP Class	1.2.840.10008.1.1	Explicit VR Big Endian	1.2.840.10008.1.2.2	SCU	None
		Explicit VR Little Endian	1.2.840.10008.1.2.1		
		Implicit VR Little Endian	1.2.840.10008.1.2		

2.3.1.2.3.3 Transfer Syntax Selection Policies

The selected transfer syntax is based on the proposed transfer syntax list. The priority order is Explicit VR Big Endian, Explicit VR Little Endian and Implicit VR Little Endian.

2.3.1.2.4 Real-World Activity D (‘Worklist Query’ Operation)

2.3.1.2.4.1 Associated Real-World Activity

The user may initiate a query from the Worklist screen, by pressing Query.

Automatic query can be performed, by setting the polling interval in Configuration Screen. EchoPAC will then perform a query according to that time interval, but not when the user is in worklist screen. The last entered search criteria will be used.

2.3.1.2.4.2 Proposed Presentation Context Tables

Presentation Context Table - Proposed					
Abstract Syntax		Transfer Syntax		Role	Extended Negotiation
Name	UID	Name List	UID List		
Basic Worklist Management SOP Class	1.2.840.10008.5.1.4.31	Explicit VR Big Endian	1.2.840.10008.1.2.2	SCU	None
		Explicit VR Little Endian	1.2.840.10008.1.2.1		
		Implicit VR Little Endian	1.2.840.10008.1.2		
Modality Performed Procedure Step SOP Class	1.2.840.10008.3.1.2.3.3	Explicit VR Big Endian	1.2.840.10008.1.2.2	SCU	None
		Explicit VR Little Endian	1.2.840.10008.1.2.1		
		Implicit VR Little Endian	1.2.840.10008.1.2		

2.3.1.2.4.3 Transfer Syntax Selection Policies

The selected transfer syntax is based on the proposed transfer syntax list. The priority order is Explicit VR Big Endian, Explicit VR Little Endian and Implicit VR Little Endian.

2.3.1.2.5 Real-World Activity E (‘Print’ Operation)

2.3.1.2.5.1 Associated Real-World Activity

Upon a request by the operator, print jobs will be sent to a DICOM Print SCP. If an error occurs during the transmission, the current association is released and a new association initiated. The maximum number of retries is configurable.

2.3.1.2.5.2 Proposed Presentation Context Tables

The following table is used when the Transfer syntax setting for the printer is “All”. If the setting is “Little Endian” only Implicit VR Little Endian will be used.

Presentation Context Table - Proposed					
Abstract Syntax		Transfer Syntax		Role	Extended Negotiation
Name	UID	Name List	UID List		
Basic Grayscale Print Management Meta SOP Class	1.2.840.10008.5.1.1.9	Explicit VR Big Endian	1.2.840.10008.1.2.2	SCU	None
		Explicit VR Little Endian	1.2.840.10008.1.2.1		
		Implicit VR Little Endian	1.2.840.10008.1.2		
Basic Color Print Management Meta SOP Class	1.2.840.10008.5.1.1.18	Explicit VR Big Endian	1.2.840.10008.1.2.2	SCU	None
		Explicit VR Little Endian	1.2.840.10008.1.2.1		
		Implicit VR Little Endian	1.2.840.10008.1.2		

2.3.1.2.5.3 Transfer Syntax Selection Policies

The selected transfer syntax is based on the proposed transfer syntax list. The priority order is Explicit VR Big Endian, Explicit VR Little Endian and Implicit VR Little Endian.

2.3.1.3 Association Acceptance Policy

The AE accepts an association only when EchoPAC receives a Verification Request from another network device.

2.3.1.3.1 Real-World Activity C ('Echo' Operation)

2.3.1.3.1.1 Associated Real-World Activity

An incoming Verification Request will cause the AE to accept the association and respond with a Verification Response.

2.3.1.3.1.2 Accepted Presentation Context Table

Presentation Context Table - Accepted					
Abstract Syntax		Transfer Syntax		Role	Extended Negotiation
Name	UID	Name List	UID List		
Verification SOP Class	1.2.840.10008.1.1	Explicit VR Big Endian	1.2.840.10008.1.2.2	SCP	None
		Explicit VR Little Endian	1.2.840.10008.1.2.1		
		Implicit VR Little Endian	1.2.840.10008.1.2		

2.3.1.3.1.2.1 SOP Specific DICOM Conformance Statement for Verify SOP Class

The AE provides standard conformance to the Verification SOP Class as an SCP.

2.3.1.3.1.3 Presentation Context Acceptance Criterion

No criterion.

2.3.1.3.1.4 Transfer Syntax Selection Policies

The selected transfer syntax is based on the proposed transfer syntax list. The priority order is Explicit VR Big Endian, Explicit VR Little Endian and Implicit VR Little Endian.

2.4 COMMUNICATION PROFILES

2.4.1 Supported Communication Stacks (PS 3.8, PS 3.9)

DICOM Upper Layer (PS 3.8) is supported using TCP/IP.

2.4.2 OSI Stack

OSI stack not supported

2.4.2.1 International Standardized Profile (ISP)

ISP not supported.

2.4.2.2 API

Not applicable to this product.

2.4.2.3 Physical Media Support

These products support 10 Megabits pr second transmission.

2.4.3 TCP/IP Stack

The TCP/IP stack is inherited from a Mac OS Operating System.

2.4.3.1 API

Not applicable to this product.

2.4.4 Point-to-Point Stack

A 50-pin ACR-NEMA connection is not applicable to this product.

2.5 EXTENSIONS / SPECIALIZATIONS / PRIVATIZATIONS

If so configured, EchoPAC will send patient demographics and report data in private data elements, according to the following table:

Element Name	Tag	VR	VM	Description
Private Creator	7F01,00xx	LO	1	GEMS_Ultrasound_EPReport_001
REPORT	7F01,xx01	UT	1-n	Report data
PATIENT DEMOGRAPHICS	7F01,xx02	UT	1-n	Patient demographics data

2.6 CONFIGURATION

2.6.1 AE Title/Presentation Address Mapping

The Local AE title is configurable through the Config Setup screen.

2.6.2 Configurable Parameters

The following fields are configurable for this AE (local):

- Local AE Title.
- JPEG quality: 0-100, preferably 80-100.
- JPEG encoding for RGB images (YBR_FULL or YBR_FULL_422).
- Station Name.
- Institution Address.
- Raw data image size as a fraction of display size. (DICOM image information in a File on disc is not changed when save to Storage SCP).
- Enabling/disabling of private tag.
- Disk for temporary storage of DICOM images.
- Frame rate reduction (25 fps, 30 fps or No reduction).
- Debug level (Off, Medium or Full).
- Verification support: OK/None
- Local listen port for Verification support.
- Which type 2 and 3 DICOM attributes are required in the DICOM message (Advanced Settings).

Through the Mac TCP/IP configuration, the

- local IP address
- local IP netmask
- local routing table information

can be set.

The following fields are configurable for each remote Storage SCP:

- Remote AE Title.
- Remote IP Address.
- Remote Listening TCP/IP Port Number.
- Number of retries
- Retry interval.
- Timeout.
- Verification support: OK/None
- Color encoding support: Full, RGB only, Palette, Black & White or RGB&Black/White.
- Compression: Default, None, None 1s., RLE or JPEG (Baseline).
- IOD support: Ultrasound, Ultrasound Multiframe, Secondary Captured
- PDU Length.

- Type 3 elements encoding: OK/None.
- Reopen Transmission setting: Image, Series, Study, Patient or Session.

The following fields are configurable for each remote Print SCP:

- Remote AE Title.
- Remote IP Address.
- Remote Listening TCP/IP Port Number.
- Number of retries
- Retry interval.
- Timeout.
- Verification support: OK/None
- Color support: OK/No.
- PDU Length.
- Transfer syntax: All or Little Endian only.
- Enabling/disabling fixed matrix size for all images on one film.
- Enabling/disabling automatic sending of full film.
- Default print job configuration.

The following fields are configurable for Worklist SCP:

- Remote AE Title.
- Remote IP Address.
- Remote Listening TCP/IP Port Number.
- Number of retries
- Retry interval.
- Timeout.
- Polling interval.
- Maximum number of downloaded entries.

The following fields are configurable for Modality Performed Procedure Step SCP:

- Remote AE Title.
- Remote IP Address.
- Remote Listening TCP/IP Port Number.
- Number of retries
- Retry interval.
- Timeout.

The following fields are configurable for Storage Commitment SCP:

- Remote AE Title.
- Remote IP Address.
- Remote Listening TCP/IP Port Number.
- Number of retries
- Retry interval.
- Timeout.
- Number of days to keep request failed or unanswered request messages.

2.7 SUPPORT OF EXTENDED CHARACTER SETS

EchoPAC will support only the ISO_IR 100 (ISO 8859-1:1987 Latin alphabet N 1. supplementary set) as extended character sets. Any incoming SOP instance that is encoded using another extended character set will not be displayed or imported.

3. MEDIA STORAGE CONFORMANCE STATEMENT

3.1 INTRODUCTION

This section of the conformance statement (CS) specifies the EchoPAC compliance to DICOM Media Interchange. It details the DICOM Media Storage Application Profiles and roles, which are supported by this product.

EchoPAC is able to export raw data files or screen captured object to DICOM media, browse DICOM media or import SOP instances from DICOM media.

3.2 IMPLEMENTATION MODEL

3.2.1 Application Data Flow Diagram

The Basic and Specific Application models for this device are shown in the following Illustration:

ILLUSTRATION 3-1
SPECIFIC AE APPLICATION MODEL

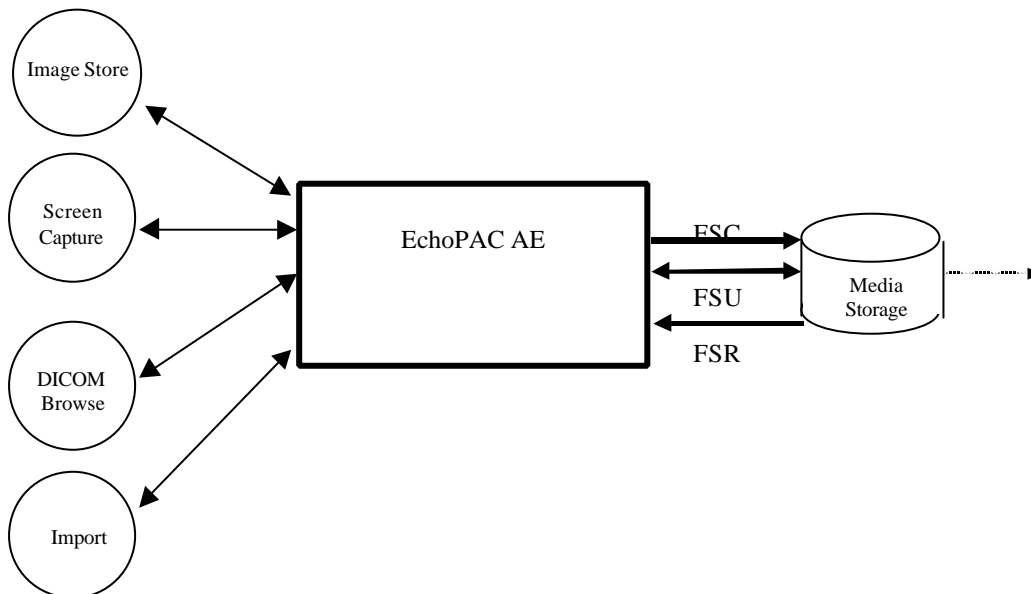

The EchoPAC device has a local storage that is capable of containing various SOP instances. These may have been obtained by network or by removable media using other application entities. These instances are external to this conformance claim and the origin of the SOP instances is outside the scope of this claim.

EchoPAC can initialize Media by acting as an FSC to create a new DICOM File-set on either 320 MB MOD, 640 MB MOD, 1.2 GB MOD, 2.4 GB MOD or Floppy. The SOP instances written to media must be one of the instances supported by EchoPAC. A pre-existing File-set will be updated with the information in DICOM files copied to media.

3.2.2 Functional Definition of AE's

EchoPAC can perform these functions:

- Create a new DICOM File-set on media
- Update DICOM File-set by adding new SOP instances to the File-set
- Display information and image previews from the existing File-set
- Copy SOP instances from the MOD onto local archive

3.2.3 Sequencing Requirements

None applicable

3.2.4 File Meta Information Options (See PS3.10)

The File Meta-Information for this implementation is:

File Meta-Information Version	1
EchoPAC Implementation UID	1.2.840.113619.6.71
Implementation Version Name	EchoPAC_6_3_2

Note: The Implementation Version Name and may change in the future without modification of this document.

3.3 AESPECIFICATIONS

3.3.1 EchoPAC AE Specification

The EchoPAC Application Entity provides standard conformance to DICOM Interchange Option of the Media Storage Service Class. The application Profiles and roles are listed below.

Supported Application Profile	Real World Activity	Role	Description
STD-GEN-CD, STD-US-ID-SF-CDR	Browse	FSR	Interchange
	Import	FSR	Interchange
STD-US-CC-SF-FLOP, STD-US-CC-SF-MOD230, STD-US-CC-SF-MOD650, STD-US-CC-SF-MOD12, STD-US-CC-SF-MOD23, STD-US-CC-MF-FLOP, STD-US-CC-MF-MOD230, STD-US-CC-MF-MOD650, STD-US-CC-MF-MOD12, STD-US-CC-MF-MOD23	Image Store	FSR/ FSC/ FSU	Interchange
	Browse	FSR	Interchange
	Import	FSR	Interchange

Note: EchoPAC can also write Secondary Capture images to media. The above application profiles are valid for writing, only when writing single-frame or multi-frame.

3.3.1.1 File Meta Information for the EchoPAC Application Entity

The Source Application Entity is set from the EchoPAC local AE title. The local AE is configurable.

Following are the default value set in the File Meta Information for this AE Title:

Source Application Entity Title	EchoPAC
--	----------------

3.3.1.2 Real-World Activities for the EchoPAC Application Entity

3.3.1.2.1 Real-World Activity "Image Store"

"Image Store" saves a DICOM SOP instance to media and updates DICOM File Set. If the original image is a DICOM file, the DICOM SOP instance is copied from the local storage media, if not the image is loaded and displayed, and then encoded into a DICOM SOP Instance.

3.3.1.2.1.1 Media Storage Application Profile for the RWA "Image Store":

For the list of Application Profiles that invoke this AE for "Image Store" RWA, see the Table in Section 3.3.1 "EchoPAC AE Specification" where the table describing the profiles and real-world activities is defined.

3.3.1.2.1.1.1 Options

Following are the SOP Classes supported by the RWA "Image Store":

Information Object Definition	SOP Class UID	Transfer Syntax	Transfer Syntax UID
DICOM Media Storage Directory	1.2.840.10008.1.3.10	Explicit VR Little Endian	1.2.840.10008.1.2.1
Ultrasound Multi-frame Image Storage	1.2.840.10008.5.1.4.1.1.3.1	Explicit VR Little Endian	1.2.840.10008.1.2.1
		Run Length Encoding, RLE	1.2.840.10008.1.2.5
		JPEG Baseline	1.2.840.10008.1.2.4.50
Ultrasound Multi-frame Image Storage(retired)	1.2.840.10008.5.1.4.1.1.3	Explicit VR Little Endian	1.2.840.10008.1.2.1
		Run Length Encoding, RLE	1.2.840.10008.1.2.5
		JPEG Baseline	1.2.840.10008.1.2.4.50

Ultrasound Image Storage	1.2.840.10008.5.1.4.1.1.6.1	Explicit VR Little Endian Run Length Encoding, RLE JPEG Baseline	1.2.840.10008.1.2.1 1.2.840.10008.1.2.5 1.2.840.10008.1.2.4.50
Ultrasound Image Storage (retired)	1.2.840.10008.5.1.4.1.1.6	Explicit VR Little Endian Run Length Encoding, RLE JPEG Baseline	1.2.840.10008.1.2.1 1.2.840.10008.1.2.5 1.2.840.10008.1.2.4.50
Secondary Capture Image Storage	1.2.840.10008.5.1.4.1.1.7	Explicit VR Little Endian Run Length Encoding, RLE JPEG Baseline	1.2.840.10008.1.2.1 1.2.840.10008.1.2.5 1.2.840.10008.1.2.4.50

3.3.1.2.2 Real-World Activity "Screen Capture"

The " Screen Capture " RWA is a RGB screen capture. It encodes the Images into a DICOM image using the EchoPAC current Patient information. If the configuration is set to automatic storage of screen capture, the pre-selected DICOM media disk is the target, else the target disk is selected through a popup-menu. This menu shows all writeable disks mounted on EchoPAC.

3.3.1.2.2.1 Media Storage Application Profile for the RWA " Screen Capture "

For the list of Application Profiles that invoke this AE for EchoPAC RWA, see the Table in Section 3.3.1, where the table describing the profiles and real-world activities is defined.

3.3.1.2.2.1.1 Options

Following are the SOP Classes supported by the **Screen Capture**:

Information Object Definition	SOP Class UID	Transfer Syntax	Transfer Syntax UID
DICOM Media Storage Directory	1.2.840.10008.1.3.10	Explicit VR Little Endian	1.2.840.10008.1.2.1
Secondary Capture Image Storage	1.2.840.10008.5.1.4.1.1.7	Explicit VR Little Endian	1.2.840.10008.1.2.1
		Run Length Encoding, RLE	1.2.840.10008.1.2.5
		JPEG Baseline	1.2.840.10008.1.2.4.50

3.3.1.2.3 Real-World Activity "DICOM Browse"

DICOM Browse is activated pressing

- DICOM Import. The mounted disks are scanned for DICOMDIR located at the root directory. If one DICOMDIR is found the selection of DICOMDIR is automatic, if several DICOMDIR is found the DICOMDIR is found using a menu selection.
- Both keys <option> and DICOM Import. A file selection menu appears, and a selection of directory and file name is done. If the located file has name DICOMDIR, the DICOMDIR found is opened, if the located file is not DICOMDIR, all the DICOM files in the directory in question is scanned and a DICOMDIR is created in memory. This option is a way to located DICOMDIR outside the root level. It also allows browsing DICOM instances outside a DICOM File set or DICOM instances supported by a corrupted DICOMDIR.
- The browse display then presents a list of patients, studies, series and images. At series level only records containing modality "US" is presented. On image level a preview image is presented, using the first frame in case of a multiframe DICOM object. On selecting a single image by a double-click using the mouse loads the image into memory and EchoPAC displays this DICOM file using the whole display area.
- Selection of images to be imported is done from this display.

3.3.1.2.4 Media Storage Application Profile for the RWA "DICOM Browse"

For the list of Application Profiles that invoke this AE for Import RWA, see the Table in Section 3.2.1 "EchoPAC AE Specification".

3.3.1.2.4.1.1 Options

Following are the SOP Classes supported by the RWA DICOM Browse:

Information Object Definition	SOP Class UID	Transfer Syntax	Transfer Syntax UID
DICOM Media Storage Directory	1.2.840.10008.1.3.10	Explicit VR Little Endian	1.2.840.10008.1.2.1
Ultrasound Multi-frame Image Storage	1.2.840.10008.5.1.4.1.1.3.1	Explicit VR Little Endian	1.2.840.10008.1.2.1
		Run Length Encoding, RLE	1.2.840.10008.1.2.5
		JPEG Baseline	1.2.840.10008.1.2.4.50
Ultrasound Multi-frame Image Storage(retired)	1.2.840.10008.5.1.4.1.1.3	Explicit VR Little Endian	1.2.840.10008.1.2.1
		Run Length Encoding, RLE	1.2.840.10008.1.2.5
		JPEG Baseline	1.2.840.10008.1.2.4.50
Ultrasound Image Storage	1.2.840.10008.5.1.4.1.1.6.1	Explicit VR Little Endian	1.2.840.10008.1.2.1
		Run Length Encoding, RLE	1.2.840.10008.1.2.5

		JPEG Baseline	1.2.840.10008.1.2.4.50
Ultrasound Image Storage (retired)	1.2.840.10008.5.1.4.1.1.6	Explicit VR Little Endian	1.2.840.10008.1.2.1
		Run Length Encoding, RLE	1.2.840.10008.1.2.5
		JPEG Baseline	1.2.840.10008.1.2.4.50
Secondary Capture Image Storage	1.2.840.10008.5.1.4.1.1.7	Explicit VR Little Endian	1.2.840.10008.1.2.1
		Run Length Encoding, RLE	1.2.840.10008.1.2.5
		JPEG Baseline	1.2.840.10008.1.2.4.50

3.3.1.2.5 Real-World Activity " Import "

The " Import " RWA first extracts Patient data from the DICOM message. This information is presented for the user. The information is editable for the user before a confirmation is requested.

Then the patient archive is searched to check if the patient is already defined in the archive.

If the patient resides in the archive, a confirmation of is requested.

If the patient is not found in the archive, a confirmation of creating a new patient is requested.

If the confirmation of the patient data is denied the import is cancelled.

If the confirmation is positive, the DICOM files are not modified in any way, only copied in to a file, using the folder and file name standard within EchoPAC. Study and Series data are extracted and copied into the EchoPAC archive.

3.3.1.2.5.1 Media Storage Application Profile for the RWA " Import "

For the list of Application Profiles that invoke this AE for Import RWA, see the Table in Section 3.2.1 "EchoPAC AE Specification".

3.3.1.2.5.1.1 Options

Following are the SOP Classes supported by the Import RWA:

Information Object Definition	SOP Class UID	Transfer Syntax	Transfer Syntax UID
DICOM Media Storage Directory	1.2.840.10008.1.3.10	Explicit VR Little Endian	1.2.840.10008.1.2.1
Ultrasound Multi-frame Image Storage	1.2.840.10008.5.1.4.1.1.3.1	Explicit VR Little Endian	1.2.840.10008.1.2.1

		Run Length Encoding, RLE	1.2.840.10008.1.2.5
		JPEG Baseline	1.2.840.10008.1.2.4.50
Ultrasound Multi-frame Image Storage(retired)	1.2.840.10008.5.1.4.1.1.3	Explicit VR Little Endian	1.2.840.10008.1.2.1
		Run Length Encoding, RLE	1.2.840.10008.1.2.5
		JPEG Baseline	1.2.840.10008.1.2.4.50
Ultrasound Image Storage	1.2.840.10008.5.1.4.1.1.6.1	Explicit VR Little Endian	1.2.840.10008.1.2.1
		Run Length Encoding, RLE	1.2.840.10008.1.2.5
		JPEG Baseline	1.2.840.10008.1.2.4.50
Ultrasound Image Storage (retired)	1.2.840.10008.5.1.4.1.1.6	Explicit VR Little Endian	1.2.840.10008.1.2.1
		Run Length Encoding, RLE	1.2.840.10008.1.2.5
		JPEG Baseline	1.2.840.10008.1.2.4.50
Secondary Capture Image Storage	1.2.840.10008.5.1.4.1.1.7	Explicit VR Little Endian	1.2.840.10008.1.2.1
		Run Length Encoding, RLE	1.2.840.10008.1.2.5
		JPEG Baseline	1.2.840.10008.1.2.4.50

3.4 AUGMENTED AND PRIVATE APPLICATION PROFILES

No augmented/private profile is implemented.

3.5 EXTENSIONS, SPECIALIZATIONS, PRIVATIZATIONS OF SOP CLASSES AND TRANSFER SYNTAXES

If so configured, EchoPAC will save patient demographics and report data in private data elements, according to the following table:

Element Name	Tag	VR	VM	Description
Private Creator	7F01,00xx	LO	1	GEMS_Ultrasound_EPReport_001
REPORT	7F01,xx01	UT	1-n	Report data
PATIENT DEMOGRAPHICS	7F01,xx02	UT	1-n	Patient demographics data

3.6 CONFIGURATION

The following parameters are configurable:

- Compression: None, JPEG Baseline or RLE.
- Source AE Title in the File Meta-Information set From EchoPAC's AE Title
- JPEG quality: 0-100, preferably 80-100.
- JPEG encoding for RGB images (YBR_FULL or YBR_FULL_422).
- Station Name.
- Institution Address.
- Auto store of Secondary Captured objects: OFF/Media
- Storage Volume for Secondary Capture: Disk name.
- Raw data image size as a fraction of display size. (DICOM image information in a File on disc is not changed when save to DICOM media).
- Enabling/disabling of private tag.
- Frame rate reduction (25 fps, 30 fps or No reduction).
- Debug level (Off, Medium or Full).
- Which type 2 and 3 DICOM attributes are required in the DICOM message (Advanced Settings).

3.7 SUPPORT OF EXTENDED CHARACTER SETS

The EchoPAC will support only the ISO_IR 100 (ISO 8859-1:1987 Latin alphabet N 1. supplementary set) as extended character sets. Any incoming SOP instance that is encoded using another extended character set will not be read or imported.

4. ULTRASOUND (US) INFORMATION OBJECT IMPLEMENTATION

4.1 INTRODUCTION

This section specifies the use of the DICOM US Image IOD to represent the information included in US images produced by this implementation. Corresponding attributes are conveyed using the module construct. The contents of this section are:

4.2 - IOD Implementation

4.3 - IOD Entity-Relationship Model

4.4 - IOD Module Table

4.5 - IOD Module Definition

4.2 US IOD IMPLEMENTATION

This section defines the implementation of US image information object.

4.3 USE ENTITY-RELATIONSHIP MODEL

The Entity-Relationship diagram for the US Image interoperability schema is shown in Illustration 4.3-1. In this figure, the following diagrammatic convention is established to represent the information organization:

- each entity is represented by a rectangular box
- each relationship is represented by a diamond shaped box.
- the fact that a relationship exists between two entities is depicted by lines connecting the corresponding entity boxes to the relationship boxes.

The relationships are fully defined with the maximum number of possible entities in the relationship shown. In other words, the relationship between Series and Image can have up to n Images per Series, but the Patient to Study relationship has 1 Study for each Patient (a Patient can have more than one Study on the system, however each Study will contain all of the information pertaining to that Patient).

ILLUSTRATION 4.3-1
 US IMAGE ENTITY RELATIONSHIP DIAGRAM

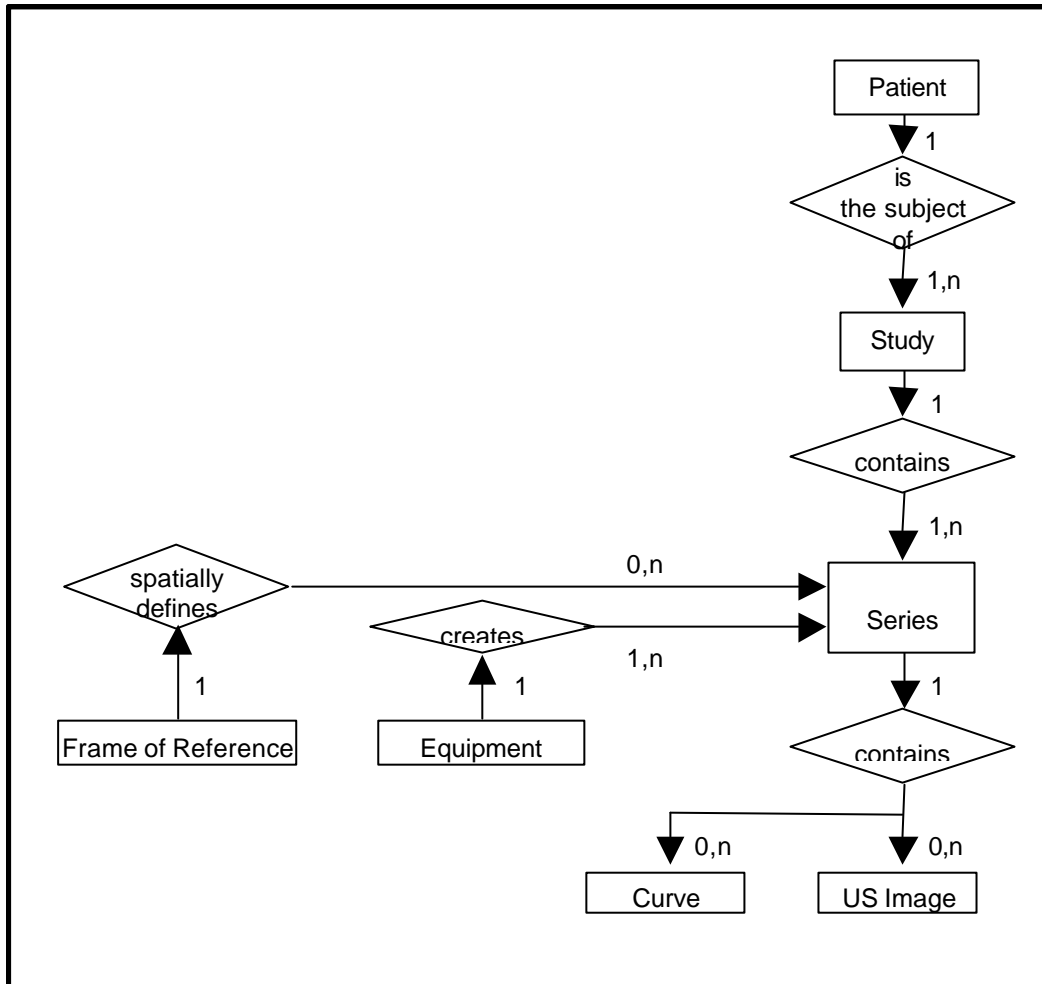

4.3.1 Entity Descriptions

Please refer to DICOM Standard Part 3 (Information Object Definitions) for a description of each of the entities contained within the US Information Object.

4.3.2 EchoPAC Mapping of DICOM Entities

TABLE 4.3-1
 MAPPING OF DICOM ENTITIES TO ECHO PAC ENTITIES

DICOM	EchoPAC Entity
Patient	Patient
Study	Exam
Series	Exam
Image	Image
Curve	Not used

4.4 IOD MODULE TABLE

Within an entity of the DICOM v3.0 US IOD, attributes are grouped into related set of attributes. A set of related attributes is termed a module. A module facilitates the understanding of the semantics concerning the attributes and how the attributes are related with each other. A module grouping does not infer any encoding of information into datasets.

Table 4.4-1 identifies the defined modules within the entities, which comprise the DICOM v3.0 US IOD. Modules are identified by Module Name.

See DICOM v3.0 Part 3 for a complete definition of the entities, modules, and attributes.

Only the single frame US Image IOD is described here.

TABLE 4.4-1
US IMAGE IOD MODULES

Entity Name	Module Name	Reference
Patient	Patient	4.5.1.1
Study	General Study	4.5.2.1
	Patient Study	4.5.2.2
Series	General Series	4.5.3.1
Frame of Reference	Frame of Reference	Not used
	US Frame of Reference	Not used
Equipment	General Equipment	4.5.4.1
Image	General Image	4.5.5.1
	Image Pixel	4.5.5.2
	Contrast/Bolus	4.5.5.3
	Palette Color Lookup Table	4.5.5.4
	US Region Calibration	4.5.7.1
	US Image	4.5.7.2
	Overlay Plane	Not used
	VOI LUT	4.5.5.5
	SOP Common	4.5.6.1
Curve	Not used	

The Image and Curve IEs are mutually exclusive. Each SOP Instance using this IOD shall contain exactly one of these IODs. Indicate here whether or not Curve entities are created by this implementation.

4.5 INFORMATION MODULE DEFINITIONS

Please refer to DICOM v3.0 Standard Part 3 (Information Object Definitions) for a description of each of the entities and modules contained within the US Information Object.

The following modules are included to convey Enumerated Values, Defined Terms, and Optional Attributes supported. Type 1 & Type 2 Attributes are also included for completeness and to define what values they may take and where these values are obtained. It should be noted that they are the same ones as defined in the DICOM v3.0 Standard Part 3 (Information Object Definitions).

4.5.1 Common Patient Entity Modules

4.5.1.1 Patient Module

This section specifies the Attributes of the Patient that describe and identify the Patient who is the subject of a diagnostic Study. This Module contains Attributes of the patient that are needed for diagnostic interpretation of the Image and are common for all studies performed on the patient.

**TABLE 4.5-1
PATIENT MODULE ATTRIBUTES**

Attribute Name	Tag	Type	Attribute Description
Patient's Name	(0010,0010)	2	May be entered from User Interface. Only first and last names are used. The number of characters is limited to the number allowed by the New Patient screen (31 characters each for first and last). Import: illegal and excess characters are removed. Taken from worklist if it is there.
Patient ID	(0010,0020)	2	May be entered from User Interface. Limited to the number of characters allowed by the New Patient screen (31 characters). If there is no Patient Id entered by the user, EchoPAC will create one from Patient Name and Patient's Birth Date. Import: Illegal characters are replaced with space and excess characters are removed. Taken from worklist if it is there.
Patient's Birth Date	(0010,0030)	2	May be entered from User Interface. Taken from worklist if it is there.
Patient's Sex	(0010,0040)	2	May be entered from User Interface, New Patient screen; limited to 'M' and 'F'. Import: Undefined will be set to Male. Taken from worklist if it is there.
Referenced Patient Sequence	(0008,1120)	3	Taken from worklist if it is there.
>Referenced SOP Class UID	(0008,1150)	1C	Taken from worklist if it is there.
>Referenced SOP Instance UID	(0008,1155)	1C	Taken from worklist if it is there.
Patient's Birth Time	(0010,0032)	3	Not used
Other Patient IDs	(0010,1000)	3	Taken from worklist if it is there.
Other Patient Names	(0010,1001)	3	Not used
Ethnic Group	(0010,2160)	3	Taken from worklist if it is there.
Patient Comments	(0010,4000)	3	Taken from worklist if it is there.

4.5.2 Common Study Entity Modules

The following Study IE Modules are common to all Composite Image IODs which reference the Study IE. These modules contain Attributes of the patient and study that are needed for diagnostic interpretation of the image.

4.5.2.1 General Study Module

This section specifies the attributes that describe and identify the Study performed upon the Patient.

**TABLE 4.5-2
GENERAL STUDY MODULE ATTRIBUTES**

Attribute Name	Tag	Type	Attribute Description
Study Instance UID	(0020,000D)	1	Uniquely generated by the equipment
Study Date	(0008,0020)	2	Is set to examination date
Study Time	(0008,0030)	2	Is set to examination time
Referring Physician's Name	(0008,0090)	2	May be entered from User Interface, New Patient screen. The number of characters is limited to 31 characters each for first and last. Import: only first and last name used. Illegal characters and excess characters are removed. Taken from worklist if it is there.
Study ID	(0020,0010)	2	Taken from worklist if it is there (in Requested Procedure Id).
Accession Number	(0008,0050)	2	May be entered from user interface, New Patient screen. Only first 16 characters are exported. Taken from worklist if it is there.
Study Description	(0008,1030)	3	Taken from worklist if it is there (in Requested Procedure Description).
Physician(s) of Record	(0008,1048)	3	Taken from worklist if it is there.
Name of Physician(s) Reading Study	(0008,1060)	3	Not used
Referenced Study Sequence	(0008,1110)	3	Taken from worklist if it is there.
>Referenced SOP Class UID	(0008,1150)	1C	Taken from worklist if it is there.
>Referenced SOP Instance UID	(0008,1155)	1C	Taken from worklist if it is there.

4.5.2.2 Patient Study Module

This section defines attributes that provide information about the Patient at the time that the Study was performed.

**TABLE 4.5-3
PATIENT STUDY MODULE ATTRIBUTES**

Attribute Name	Tag	Type	Attribute Description
Admitting Diagnoses Description	(0008,1080)	3	May be entered from user interface in referral reason. Import: Illegal characters are removed.
Patient's Age	(0010,1010)	3	Not used

Attribute Name	Tag	Type	Attribute Description
Patient's Size	(0010,1020)	3	May be entered from User Interface. Taken from worklist if it is there.
Patient's Weight	(0010,1030)	3	May be entered from User Interface. Taken from worklist if it is there.
Occupation	(0010,2180)	3	Not used
Additional Patient's History	(0010,21B0)	3	Taken from worklist if it is there.

4.5.3 Common Series Entity Modules

The following Series IE Modules are common to all Composite Image IODs which reference the Series IE.

4.5.3.1 General Series Module

This section specifies the attributes that identify and describe general information about the Series within a Study.

**TABLE 4.5-4
GENERAL SERIES MODULE ATTRIBUTES**

Attribute Name	Tag	Type	Attribute Description
Modality	(0008,0060)	1	Defined Term "US" used.
Series Instance UID	(0020,000E)	1	Uniquely generated by the equipment
Series Number	(0020,0011)	2	Internal number which is incremented for each new exam within a study
Laterality	(0020,0060)	2C	Not used
Series Date	(0008,0021)	3	Is set to Examination date
Series Time	(0008,0031)	3	Is set to Examination time
Performing Physicians' Name	(0008,1050)	3	Taken from worklist if it is there
Protocol Name	(0018,1030)	3	Not used
Series Description	(0008,103E)	3	May be entered from User Interface as Diagnosis. Import: Illegal characters are removed.
Operators' Name	(0008,1070)	3	May be entered from User Interface (limited to initials or 3-digit ID) Import: Truncation to 3 digits; illegal characters are removed.
Referenced Study Component Sequence	(0008,1111)	3	Not used
>Referenced SOP Class UID	(0008,1150)	1C	Not used
>Referenced SOP Instance UID	(0008,1155)	1C	Not used
Body Part Examined	(0018,0015)	3	Not used
Patient Position	(0018,5100)	2C	Not used
Smallest Pixel Value in Series	(0028,0108)	3	Not used
Largest Pixel Value in Series	(0028,0109)	3	Not used

4.5.4 Common Equipment Entity Modules

The following Equipment IE Module is common to all Composite Image IODs, which reference the Equipment IE.

4.5.4.1 General Equipment Module

This section specifies the attributes that identify and describe the piece of equipment, which produced a Series of Images.

**TABLE 4.5-5
GENERAL EQUIPMENT MODULE ATTRIBUTES**

Attribute Name	Tag	Type	Attribute Description
Manufacturer	(0008,0070)	2	Is set to "GE Vingmed Ultrasound"
Institution Name	(0008,0080)	3	Is set to EchoPAC's field Location, as specified in Config. screen, operator level.
Institution Address	(0008,0081)	3	Is set to configuration from Config. screen.
Station Name	(0008,1010)	3	Is set to configuration from Config. screen.
Institutional Department Name	(0008,1040)	3	Not used
Manufacturer's Model Name	(0008,1090)	3	Is set to "EchoPAC".
Device Serial Number	(0018,1000)	3	Not used
Software Versions	(0018,1020)	3	EchoPAC software version
Spatial Resolution	(0018,1050)	3	Not used
Date of Last Calibration	(0018,1200)	3	Not used
Time of Last Calibration	(0018,1201)	3	Not used
Pixel Padding Value	(0028,0120)	3	Not used

4.5.5 Common Image Entity Modules

The following Image IE Modules are common to all Composite Image IODs which reference the Image IE.

4.5.5.1 General Image Module

This section specifies the attributes that identify and describe an image within a particular series.

**TABLE 4.5-6
GENERAL IMAGE MODULE ATTRIBUTES**

Attribute Name	Tag	Type	Attribute Description
Image Number	(0020,0013)	2	Internal value which is incremented for each captured image, within a series (within a study),
Patient Orientation	(0020,0020)	2C	Not used
Image Date	(0008,0023)	2C	Set from Image date or image capture date
Image Time	(0008,0033)	2C	Set from Image time or image capture time
Image Type	(0008,0008)	3	Value "ORIGINAL/PRIMARY" or "SECONDARY/DERIVED".

Attribute Name	Tag	Type	Attribute Description
Acquisition Number	(0020,0012)	3	Not used
Acquisition Date	(0008,0022)	3	Not used
Acquisition Time	(0008,0032)	3	Not used
Referenced Image Sequence	(0008,1140)	3	Not used
>Referenced SOP Class UID	(0008,1150)	1C	Not used
>Referenced SOP Instance UID	(0008,1155)	1C	Not used
Derivation Description	(0008,2111)	3	Not used
Source Image Sequence	(0008,2112)	3	Not used
>Referenced SOP Class UID	(0008,1150)	1C	Not used
>Referenced SOP Instance UID	(0008,1155)	1C	Not used
Images in Acquisition	(0020,1002)	3	Not used
Image Comments	(0020,4000)	3	Not used
Lossy Image Compression	(0028,2110)	3	Set to 01 if images is JPEG Baseline compressed

4.5.5.2 Image Pixel Module

This section specified the attributes that describe the pixel data of the image.

**TABLE 4.5-7
IMAGE PIXEL MODULE ATTRIBUTES**

Attribute Name	Tag	Type	Attribute Description
Samples per Pixel	(0028,0002)	1	Value of '1' if Photometric Interpretation element value has value 'MONOCHROME2' or 'PALETTE COLOR'. Value of '3' when Photometric Interpretation element value has value 'RGB' or 'YBR_FULL' or 'YBR_FULL_422'
Photometric Interpretation	(0028,0004)	1	Defined Values used: "MONOCHROME2", "PALETTE COLOR", "RGB", "YBR_FULL" or "YBR_FULL_422"
Rows	(0028,0010)	1	Value depends on scanning mode and configuration setup
Columns	(0028,0011)	1	Value depends on scanning mode and configuration setup.
Bits Allocated	(0028,0100)	1	Value always = 0008H.

Attribute Name	Tag	Type	Attribute Description
Bits Stored	(0028,0101)	1	Value always = 0008H.
High Bit	(0028,0102)	1	Value always = 0007H.
Pixel Representation	(0028,0103)	1	Defined Value '0' - unsigned integer.
Pixel Data	(7FE0,0010)	1	
Planar Configuration	(0028,0006)	1C	Enumerated value 0000H Enumerated Value, color-by-pixel, if Photometric Interpretation element value has value 'RGB'. Enumerated value 0001H, color-by-plane if Photometric Interpretation element value has value 'YBR_FULL_422' or 'YBR_FULL'.
Pixel Aspect Ratio	(0028,0034)	1C	Supported
Smallest Image Pixel Value	(0028,0106)	3	Not used
Largest Image Pixel Value	(0028,0107)	3	Not used
Red Palette Color Lookup Table Descriptor	(0028,1101)	1C	Has the values(256,0 ,16) if Photometric Interpretation has value "PALETTE COLOR"
Green Palette Color Lookup Table Descriptor	(0028,1102)	1C	Has the values(256,0 ,16) if Photometric Interpretation has value "PALETTE COLOR"
Blue Palette Color Lookup Table Descriptor	(0028,1103)	1C	Has the values(256,0 ,16) if Photometric Interpretation has value "PALETTE COLOR"
Red Palette Color Lookup Table Data	(0028,1201)	1C	Has 256 values if Photometric Interpretation has value "PALETTE COLOR"
Green Palette Color Lookup Table Data	(0028,1202)	1C	Has 256 values if Photometric Interpretation has value "PALETTE COLOR"
Blue Palette Color Lookup Table Data	(0028,1203)	1C	Has 256 values if Photometric Interpretation has value "PALETTE COLOR"

4.5.5.3 Contrast/Bolus Module

This section specifies the attributes that describe the contrast /bolus used in the acquisition of the Image.

**TABLE 4.5-8
CONTRAST/BOLUS MODULE ATTRIBUTES**

Attribute Name	Tag	Type	Attribute Description
Contrast/Bolus Agent	(0018,0010)	2	May be entered from User Interface, Structured reporting mode
Contrast/Bolus Agent Sequence	(0018,0012)	3	Not used
>Code Value	(0008,0100)	1C	Not used
>Coding Scheme Designator	(0008,0102)	1C	Not used
>Code Meaning	(0008,0104)	3	Not used
Contrast/Bolus Route	(0018,1040)	3	Not used
Contrast/Bolus Administration Route Sequence	(0018,0014)	3	Not used
>Code Value	(0008,0100)	1C	Not used
>Coding Scheme Designator	(0008,0102)	1C	Not used
>Code Meaning	(0008,0104)	3	Not used
>Additional Drug Sequence	(0018,002A)	3	Not used
>>Code Value	(0008,0100)	1C	Not used
>>Coding Scheme Designator	(0008,0102)	1C	Not used
>>Code Meaning	(0008,0104)	3	Not used
Contrast/Bolus Volume	(0018,1041)	3	Not used
Contrast/Bolus Start Time	(0018,1042)	3	Not used
Contrast/Bolus Stop Time	(0018,1043)	3	Not used
Contrast/Bolus Total Dose	(0018,1044)	3	Not used
Contrast Flow Rate(s)	(0018,1046)	3	Not used
Contrast Flow Duration(s)	(0018,1047)	3	Not used
Contrast/Bolus Ingredient	(0018,1048)	3	Not used
Contrast/Bolus Ingredient Concentration	(0018,1049)	3	Not used

4.5.5.4 Palette Color Lookup Table Module

This section specifies the attributes that describe the Lookup table data for images with Palette Color photometric interpretation.

**TABLE 4.5-9
PALETTE COLOR LOOKUP MODULE**

Attribute Name	Tag	Type	Attribute Description
Red Palette Color Lookup Table Descriptor	(0028,1101)	1C	Has the values(256,0 ,16) if Photometric Interpretation has value "PALETTE COLOR"
Green Palette Color Lookup Table Descriptor	(0028,1102)	1C	Has the values(256,0 ,16) if Photometric Interpretation has value "PALETTE COLOR"

Attribute Name	Tag	Type	Attribute Description
Blue Palette Color Lookup Table Descriptor	(0028,1103)	1C	Has the values(256,0 ,16) if Photometric Interpretation has value "PALETTE COLOR"
Palette Color Lookup Table UID	(0028,1199)	3	Not used
Red Palette Color Lookup Table Data	(0028,1201)	1C	Has 256 values if Photometric Interpretation has value "PALETTE COLOR"
Green Palette Color Lookup Table Data	(0028,1202)	1C	Has 256 values if Photometric Interpretation has value "PALETTE COLOR"
Blue Palette Color Lookup Table Data	(0028,1203)	1C	Has 256 values if Photometric Interpretation has value "PALETTE COLOR"
Segmented Red Palette Color Lookup Table Data	(0028,1221)	1C	Not used
Segmented Green Palette Color Lookup Table Data	(0028,1222)	1C	Not used
Segmented Red Palette Color Lookup Table Data	(0028,1223)	1C	Not used

4.5.5.5 VOILUT Module

This section specifies the attributes that identify and describe the VOI LUT Module

**TABLE 4.5-10
VOI LUT MODULE ATTRIBUTES**

Attribute Name	Tag	Type	Attribute Description
VOI LUT Sequence	(0028,3010)	3	Not used
>LUT Descriptor	(0028,3002)	3	Not used
>LUT Explanation	(0028,3003)	3	Not used
>LUT Data	(0028,3006)	3	Not used
Window Center	(0028,1050)	3	Value set to 127 if Photometric Interpretation has value MONOCHROME2.
Window Width	(0028,1051)	3	Value set to 256 if Photometric Interpretation has value MONOCHROME2.
Window Center & Width Explanation	(0028,1055)	3	Not used

4.5.6 General Modules

The SOP Common Module is mandatory for all DICOM IODs.

4.5.6.1 SOP Common Module

This section defines the attributes that are required for proper functioning and identification of the associated SOP Instances. They do not specify any semantics about the Real-World Object represented by the IOD.

TABLE 4.5-11
SOP COMMON MODULE ATTRIBUTES

Attribute Name	Tag	Type	Attribute Description
SOP Class UID	(0008,0016)	1	Set to "1.2.840.10008.5.1.4.1.1.3.1" "1.2.840.10008.5.1.4.1.1.3" "1.2.840.10008.5.1.4.1.1.6.1" "1.2.840.10008.5.1.4.1.1.6" or "1.2.840.10008.5.1.4.1.1.7"
SOP Instance UID	(0008,0018)	1	Uniquely generated by the equipment
Specific Character Set	(0008,0005)	1C	Set to "ISO_IR 100" if extended characters are used. Import: images using other extended character set than "ISO_IR 100" are rejected.
Instance Creation Date	(0008,0012)	3	Not used
Instance Creation Time	(0008,0013)	3	Not used
Instance Creator UID	(0008,0014)	3	Not used

4.5.7 US Modules

This Section describes US Series, Equipment, and Image Modules. These Modules contain attributes that are specific to US Image IOD.

4.5.7.1 US Region Calibration Module

Specify how and if the US Region Calibration Module is used to describe multiple regions which have independent data regions, e.g. quad screen loops which may have different calibration information. The data presented in the various regions of a US image can represent a multiplicity of physical parameters, e.g., spatial distance, blood velocity, time, volume, etc., and these are often contained in the value of the pixel itself. It is therefore imperative that physical information be available for the various regions of a single region independent of each other.

This section contains IOD attributes that describe an ultrasound region calibration.

TABLE 4.5-12
US REGION CALIBRATION MODULE ATTRIBUTES

Attribute Name	Tag	Type	Attribute Description
Sequence of Ultrasound Regions	(0018,6011)	1	Object contains 0 or 1 regions
>Region Location Min x_0	(0018,6018)	1	Value is 0
>Region Location Min y_0	(0018,601A)	1	Value is 0

Attribute Name	Tag	Type	Attribute Description
>Region Location Max x_1	(0018,601C)	1	Value is image width-1.
>Region Location Max y_1	(0018,601E)	1	Value is image height-1
>Physical Units X Direction	(0018,6024)	1	Enumerated Values supported: 0003H cm 0004H seconds
>Physical Units Y Direction	(0018,6026)	1	Enumerated Values supported: 0003H cm 0004H seconds 0007H cm/sec
>Physical Delta X	(0018,602C)	1	Varies with scanning mode
>Physical Delta Y	(0018,602E)	1	Varies with scanning mode
>Reference Pixel x_0	(0018,6020)	3	Varies with scanning mode
>Reference Pixel y_0	(0018,6022)	3	Varies with scanning mode
>Ref. Pixel Physical Value X	(0018,6028)	3	Varies with scanning mode
>Ref. Pixel Physical Value Y	(0018,602A)	3	Varies with scanning mode
>Region Spatial Format	(0018,6012)	1	Enumerated Values supported: 0001H 2D 0002H M-Mode 0003H Spectral
>Region Data Type	(0018,6014)	1	Enumerated Values supported: 0001H Tissue 0006H Doppler Mode Trace
>Region Flags	(0018,6016)	1	Bit 0: 0 = Opaque Bit 1: 0 = Not Protected because there may be other regions within the image Bit 2 : 0 = Velocity
>Pixel Component Organization	(0018,6044)	1C	Pixel component calibration data does not exist for any region
>Pixel Component Mask	(0018,6046)	1C	Not used
>Pixel Component Range Start	(0018,6048)	1C	Not used
>Pixel Component Range Stop	(0018,604A)	1C	Not used
>Pixel Component Physical Units	(0018,604C)	1C	Not used
>Pixel Component Data Type	(0018,604E)	1C	Not used
>Number of Table Break Points	(0018,6050)	1C	Not used
>Table of X Break Points	(0018,6052)	1C	Not used
>Table of Y Break Points	(0018,6054)	1C	Not used
>Number of Table Entries	(0018,6056)	1C	Not used
>Table of Pixel Values	(0018,6058)	1C	Not used

Attribute Name	Tag	Type	Attribute Description
>Table of Parameter Values	(0018,605A)	1C	Not used
>Transducer Frequency	(0018,6030)	3	Supported
>Pulse Repetition Frequency	(0018,6032)	3	Supported
>Doppler Correction Angle	(0018,6034)	3	Not used
>Steering Angle	(0018,6036)	3	Not used
>Doppler Sample Volume X Position	(0018,6038)	3	Not used
>Doppler Sample Volume Y Position	(0018,603A)	3	Not used
>TM-Line Position x_0	(0018,603C)	3	Not used
>TM-Line Position y_0	(0018,603E)	3	Not used
>TM-Line Position x_1	(0018,6040)	3	Not used
>TM-Line Position y_1	(0018,6042)	3	Not used

4.5.7.2 US Image Module

This section specifies the attributes that describe ultrasound images.

**TABLE 4.5-13
US IMAGE MODULE ATTRIBUTES**

Attribute Name	Tag	Type	Attribute Description
Samples Per Pixel	(0028,0002)	1	Value of '1' if Photometric Interpretation element value has value 'MONOCHROME2' or 'PALETTE COLOR'. Value of '3' when Photometric Interpretation element value has value 'RGB' or 'YBR_FULL' or 'YBR_FULL_422'
Photometric Interpretation	(0028,0004)	1	Defined Values used: "MONOCHROME2", "PALETTE COLOR", "RGB", "YBR_FULL" or "YBR_FULL_422"
Bits Allocated	(0028,0100)	1	Value always = 0008H
Bits Stored	(0028,0101)	1	Value always = 0008H
High Bit	(0028,0102)	1	Value always = 0007H
Planar Configuration	(0028,0006)	1	Enumerated value 0000H Enumerated Value, color-by-pixel, if Photometric Interpretation element value has value 'RGB'. Enumerated value 0001H, color-by-plane if Photometric Interpretation element value has value 'YBR_FULL' or 'YBR_FULL_422'
Pixel Representation	(0028,0103)	1	Always 0000H = unsigned integer.
Frame Increment Pointer	(0028,0009)	1C	Set to Frame Time if the image is multiframe IOD, Not used if the image is a single frame IOD.
Image Type	(0008,0008)	2	Value "ORIGINAL/PRIMARY" or "SECONDARY/DERIVED".
Lossy Image Compression	(0028,2110)	1C	Set to 01 if image is compressed using JPEG Baseline compression.
Number of Stages	(0008,2124)	2C	Not used
Number of Views in Stage	(0008,212A)	2C	Not used
Ultrasound Color Data Present	(0028,0014)	3	Not used
Referenced Overlay Sequence	(0008,1130)	3	Not used
>Referenced SOP Class UID	(0008,1150)	1C	Not used

Attribute Name	Tag	Type	Attribute Description
>Referenced SOP Instance UID	(0008,1155)	1C	Not used
Referenced Curve Sequence	(0008,1145)	3	Not used
>Referenced SOP Class UID	(0008,1150)	1C	Not used
>Referenced SOP Instance UID	(0008,1155)	1C	Not used
Stage Name	(0008,2120)	3	Not used
Stage Number	(0008,2122)	3	Not used
View Number	(0008,2128)	3	Not used
Number of Event Timers	(0008,2129)	3	Not used
Event Elapsed Time(s)	(0008,2130)	3	Not used
Event Timer Name(s)	(0008,2132)	3	Not used
Anatomic Region Sequence	(0008,2218)	3	Not used
>Code Value	(0008,0100)	1C	Not used
>Coding Scheme Designator	(0008,0102)	1C	Not used
>Code Meaning	(0008,0104)	3	Not used
>Anatomic Region Modifier Sequence	(0008,2220)	3	Not used
>>Code Value	(0008,0100)	1C	Not used
>>Coding Scheme Designator	(0008,0102)	1C	Not used
>>Code Meaning	(0008,0104)	3	Not used
Primary Anatomic Structure Sequence	(0008,2228)	3	Not used
>Code Value	(0008,0100)	1C	Not used
>Coding Scheme Designator	(0008,0102)	1C	Not used
>Code Meaning	(0008,0104)	3	Not used
>Primary Anatomic Structure Modifier Sequence	(0008,2230)	3	Not used
>>Code Value	(0008,0100)	1C	Not used
>>Coding Scheme Designator	(0008,0102)	1C	Not used
>>Code Meaning	(0008,0104)	3	Not used
Transducer Position Sequence	(0008,2240)	3	Not used
>Code Value	(0008,0100)	1C	Not used
>Coding Scheme Designator	(0008,0102)	1C	Not used
>Code Meaning	(0008,0104)	3	Not used
> Transducer Position Modifier Sequence	(0008,2242)	3	Not used
>>Code Value	(0008,0100)	1C	Not used
>>Coding Scheme Designator	(0008,0102)	1C	Not used
>>Code Meaning	(0008,0104)	3	Not used
Transducer Orientation Sequence	(0008,2244)	3	Not used

Attribute Name	Tag	Type	Attribute Description
>Code Value	(0008,0100)	1C	Not used
>Coding Scheme Designator	(0008,0102)	1C	Not used
>Code Meaning	(0008,0104)	3	Not used
> Transducer Orientation Modifier Sequence	(0008,2246)	3	Not used
>>Code Value	(0008,0100)	1C	Not used
>>Coding Scheme Designator	(0008,0102)	1C	Not used
>>Code Meaning	(0008,0104)	3	Not used
Trigger Time	(0018,1060)	3	Not used
Nominal Interval	(0018,1062)	3	Not used
Beat Rejection Flag	(0018,1080)	3	Not used
Low R-R Value	(0018,1081)	3	Not used
High R-R Value	(0018,1082)	3	Not used
Heart Rate	(0018,1088)	3	Set to heart rate as defined in EchoPAC
Output Power	(0018,5000)	3	Not used
Transducer Data	(0018,5010)	3	Not used
Transducer Type	(0018,6031)	3	Not used
Focus Depth	(0018,5012)	3	Not used
Preprocessing Function	(0018,5020)	3	Not used
Mechanical Index	(0018,5022)	3	Not used
Bone Thermal Index,	(0018,5024)	3	Not used
Cranial Thermal Index	(0018,5026)	3	Not used
Soft Tissue Thermal Index	(0018,5027)	3	Not used
Soft Tissue-focus Thermal Index	(0018,5028)	3	Not used
Soft Tissue-surface Thermal Index	(0018,5029)	3	Not used
Depth of Scan Field	(0018,5050)	3	Not used
Image Transformation Matrix	(0018,5210)	3	Not used
Image Translation Vector	(0018,5212)	3	Not used
Overlay Subtype	(60xx,0045)	3	Not used

5. ULTRASOUND MULTIFRAME (US MF) INFORMATION OBJECT IMPLEMENTATION

5.1 INTRODUCTION

This section specifies the use of the DICOM US Multi-frame Image IOD to represent the information included in US images produced by this implementation. Corresponding attributes are conveyed using the module construct. The contents of this section are:

4.2 - IOD Implementation

5.3 - IOD Entity-Relationship Model

4.4 - IOD Module Table

4.5 - IOD Module Definition

5.2 US IOD IMPLEMENTATION

This section defines the implementation of US Multi-Frame image information object.

5.3 US ENTITY-RELATIONSHIP MODEL

The Entity-Relationship diagram for the US Image interoperability schema is shown in Illustration 4.3-1. In this figure, the following diagrammatic convention is established to represent the information organization:

- each entity is represented by a rectangular box
- each relationship is represented by a diamond shaped box.
- the fact that a relationship exists between two entities is depicted by lines connecting the corresponding entity boxes to the relationship boxes.

The relationships are fully defined with the maximum number of possible entities in the relationship shown. In other words, the relationship between Series and Image can have up to n Images per Series, but the Patient to Study relationship has 1 Study for each Patient (a Patient can have more than one Study on the system, however each Study will contain all of the information pertaining to that Patient).

ILLUSTRATION 5.3-1
 US MULTIFRAME IMAGE ENTITY RELATIONSHIP DIAGRAM

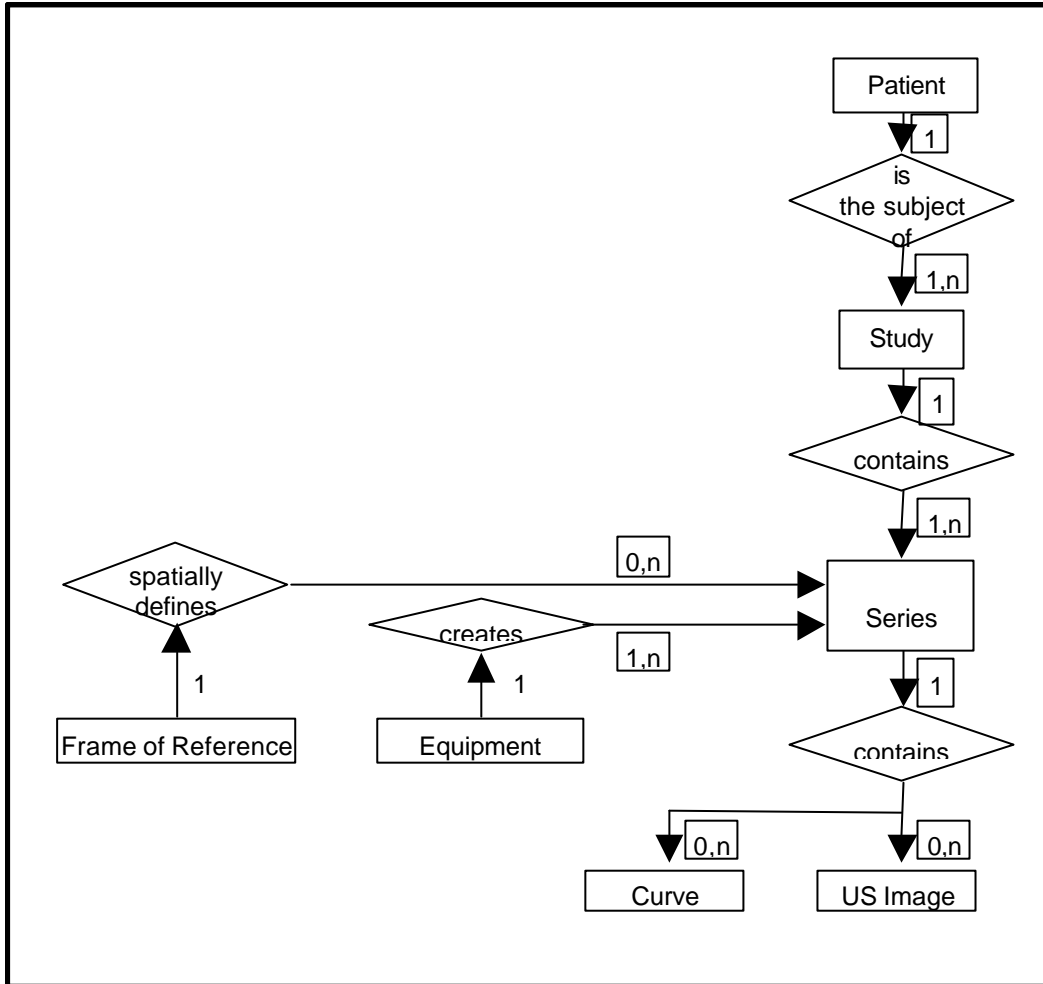

5.3.1 Entity Descriptions

Please refer to DICOM Standard Part 3 (Information Object Definitions) for a description of each of the entities contained within the US Information Object.

5.3.2 EchoPAC Mapping of DICOM entities

TABLE 5.3-1
 MAPPING OF DICOM ENTITIES TO ECHO PAC ENTITIES

DICOM	EchoPAC Entity
Patient	Patient
Study	Exam
Series	Exam
Image	Image

Curve	Not used
-------	----------

5.4 IOD MODULE TABLE

Within an entity of the DICOM v3.0 US IOD, attributes are grouped into related set of attributes. A set of related attributes is termed a module. A module facilitates the understanding of the semantics concerning the attributes and how the attributes are related with each other. A module grouping does not infer any encoding of information into datasets.

Table 4.4-1 identifies the defined modules within the entities, which comprise the DICOM v3.0 US IOD. Modules are identified by Module Name.

See DICOM v3.0 Part 3 for a complete definition of the entities, modules, and attributes.

Only the US Multi-Frame Image IOD is described here. If supported the US Multi-Frame Image IOD should be described here or elsewhere. It is used in a different SOP Class however and may not be supported by all implementations.

TABLE 5.4-1
US MULTI-FRAME IOD MODULES

Entity Name	Module Name	Reference
Patient	Patient	4.5.1.1
Study	General Study	4.5.2.1
	Patient Study	4.5.2.2
Series	General Series	4.5.3.1
Frame of Reference	Frame of Reference	Not used
	US Frame of Reference	Not used
Equipment	General Equipment	4.5.4.1
Image	General Image	4.5.5.1
	Image Pixel	4.5.5.2
	Contrast/Bolus	4.5.5.3
	Cine	5.5.1.1
	Multi-frame	5.5.1.2
	Palette Color Lookup Table	4.5.5.4
	US Region Calibration	4.5.7.1
	US Image	4.5.7.2
	Overlay Plane	Not used
	VOILUT	4.5.5.5
	SOP Common	4.5.6.1

Curve	Not used
-------	----------

The Image and Curve IEs are mutually exclusive. Each SOP Instance using this IOD shall contain exactly one of these IODs. Indicate here whether or not Curve entities are created by this implementation.

5.5 INFORMATION MODULE DEFINITIONS

Please refer to DICOM v3.0 Standard Part 3 (Information Object Definitions) for a description of each of the entities and modules contained within the US Multi-Frame Information Object.

The following modules are included to convey Enumerated Values, Defined Terms, and Optional Attributes supported. Type 1 & Type 2 Attributes are also included for completeness and to define what values they may take and where these values are obtained. It should be noted that they are the same ones as defined in the DICOM v3.0 Standard Part 3 (Information Object Definitions).

5.5.1 Common Image Modules

The following Image IE Modules are common to all Composite Image IODs which reference the Image IE.

5.5.1.1 Cine Module

TABLE 5.5-2
CINE MODULE ATTRIBUTES

Attribute Name	Tag	Type	Attribute Description
Frame Time	(0018,1063)	1C	Is set to the interframe time
Frame Time Vector	(0018,1065)	1C	Import: Average value is set to interframe time Export: Only used when sending cineloops with reduced frame rate
Start Trim	(0008,2142)	3	Not used
Stop Trim	(0008,2143)	3	Not used
Recommended Display Frame Rate	(0008,2144)	3	Not used
Cine Rate	(0018,0040)	3	Not used
Frame Delay	(0018,1066)	3	Not used
Effective Duration	(0018,0072)	3	Not used
Actual Frame Duration	(0018,1242)	3	Not used

5.5.1.2 Multi-frame Module

**TABLE 5.5-3
MULTI-FRAME MODULEMODULE ATTRIBUTES**

Attribute Name	Tag	Type	Attribute Description
Number of Frames	(0028,0008)	1	Is set to the interframe time
Frame Increment Pointer	(0028,0009)	1	Is set to Frame Time (0018,1063)

6. SC INFORMATION OBJECT IMPLEMENTATION

6.1 INTRODUCTION

This section specifies the use of the DICOM SC Image IOD to represent the information included in SC images produced by this implementation. Corresponding attributes are conveyed using the module construct. The contents of this section are:

6.2 - IOD Implementation

6.3 - IOD Entity-Relationship Model

6.4 - IOD Module Table

6.5 - IOD Module Definition

6.2 SC IOD IMPLEMENTATION

This section defines the implementation of SC image information object.

6.3 SC ENTITY-RELATIONSHIP MODEL

The Entity-Relationship diagram for the SC Image interoperability schema is shown in Illustration 6.3-1. In this figure, the following diagrammatic convention is established to represent the information organization:

- each entity is represented by a rectangular box
- each relationship is represented by a diamond shaped box.
- the fact that a relationship exists between two entities is depicted by lines connecting the corresponding entity boxes to the relationship boxes.

The relationships are fully defined with the maximum number of possible entities in the relationship shown. In other words, the relationship between Series and Image can have up to n Images per Series, but the Patient to Study relationship has 1 Study for each Patient (a Patient can have more than one Study on the system, however each Study will contain all of the information pertaining to that Patient).

ILLUSTRATION 6.3-1
 SC IMAGE ENTITY RELATIONSHIP DIAGRAM

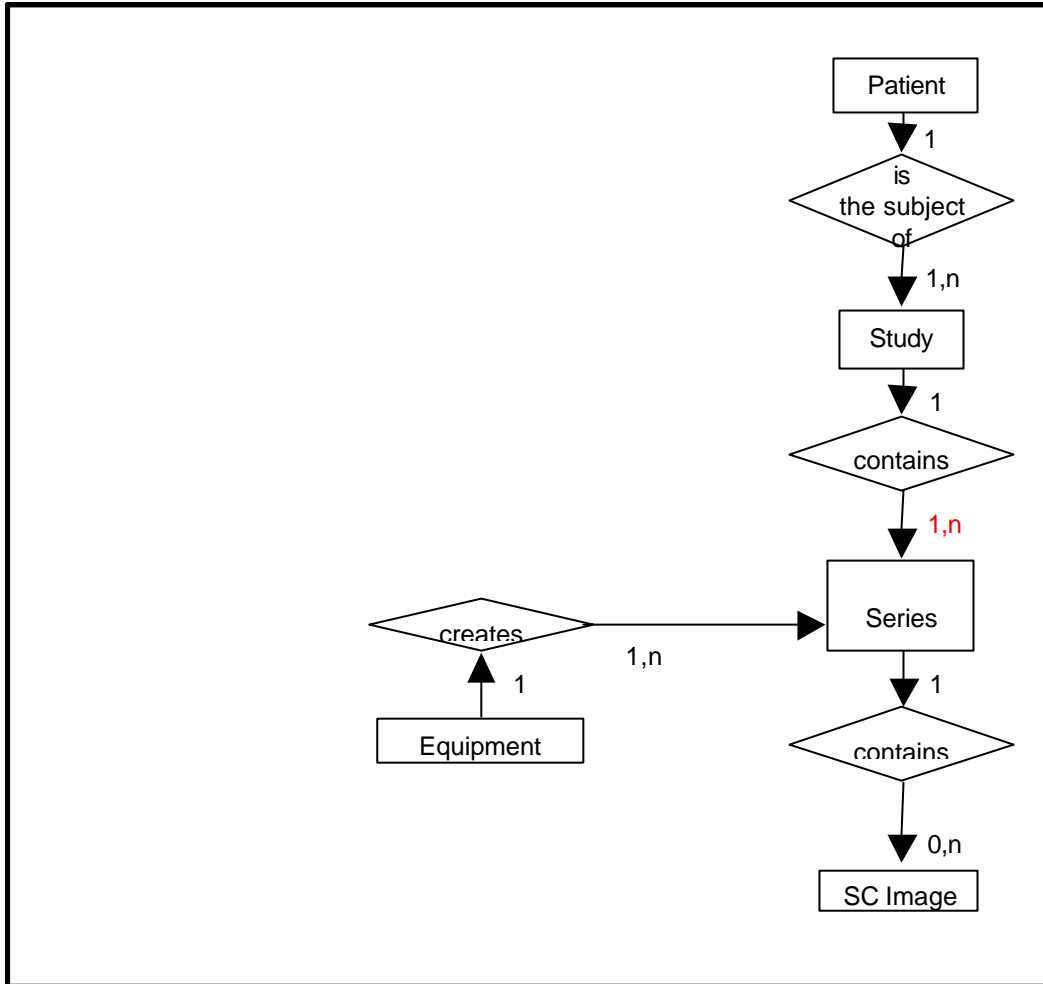

6.3.1 Entity Descriptions

Please refer to DICOM Standard Part 3 (Information Object Definitions) for a description of each of the entities contained within the SC Information Object.

6.3.2 EchoPAC Mapping of DICOM Entities

TABLE 6.3-1
 MAPPING OF DICOM ENTITIES TO ECHO PAC ENTITIES

DICOM	EchoPAC Entity
Patient	Patient
Study	Exam
Series	Exam
Image	Image

Frame	Not Applicable
-------	----------------

6.4 IOD MODULE TABLE

Within an entity of the DICOM v3.0 SC IOD, attributes are grouped into related set of attributes. A set of related attributes is termed a module. A module facilitates the understanding of the semantics concerning the attributes and how the attributes are related with each other. A module grouping does not infer any encoding of information into datasets.

Table 6.4-1 identifies the defined modules within the entities, which comprise the DICOM v3.0 SC IOD. Modules are identified by Module Name.

See DICOM v3.0 Part 3 for a complete definition of the entities, modules, and attributes.

TABLE 6.4-1
SC IMAGE IOD MODULES

Entity Name	Module Name	Reference
Patient	Patient	4.5.1.1
Study	General Study	4.5.2.1
	Patient Study	4.5.2.2
Series	General Series	4.5.3.1
Equipment	General Equipment	4.5.4.1
	SC Equipment	6.5.1.1
Image	General Image	4.5.5.1
	Image Pixel	4.5.5.2
	SC Image	6.5.1.2
	Overlay Plane	Not used
	Modality LUT	Not used
	VOILUT	4.5.5.5
	SOP Common	4.5.6.1

6.5 INFORMATION MODULE DEFINITIONS

Please refer to DICOM v3.0 Standard Part 3 (Information Object Definitions) for a description of each of the entities and modules contained within the SC Information Object.

The following modules are included to convey Enumerated Values, Defined Terms, and Optional Attributes supported. Type 1 & Type 2 Attributes are also included for completeness and to define what values they may take and where these values are obtained. It should be noted that they are the same ones as defined in the DICOM v3.0 Standard Part 3 (Information Object Definitions).

6.5.1 SC Modules

This Section describes SC Equipment, and Image Modules. These Modules contain attributes that are specific to SC Image IOD.

6.5.1.1 SC Equipment Module

This Module describes equipment used to convert images into a DICOM format.

**TABLE 6.5-2
SC IMAGE EQUIPMENT MODULE ATTRIBUTES**

Attribute Name	Tag	Type	Attribute Description
Conversion Type	(0008,0064)	1	Set to WSD (Workstation Derived)
Modality	(0008,0060)	3	Defined Value "US" used
Secondary Capture Device ID	(0018,1010)	3	Defined Value "EchoPAC"
Secondary Capture Device Manufacturer	(0018,1016)	3	Implementation defined string "GE Vingmed Ultrasound"
Secondary Capture Device Manufacturer's Model Name	(0018,1018)	3	Implementation defined string "EchoPAC"
Secondary Capture Device Software Version	(0018,1019)	3	Is set the EchoPAC software version
Video Image Format Acquired	(0018,1022)	3	Not used
Digital Image Format Acquired	(0018,1023)	3	Not used

6.5.1.2 SC Image Module

The table in this Section contains IOD attributes that describe SC images.

**TABLE 6.5-3
SC IMAGE MODULE ATTRIBUTES**

Attribute Name	Tag	Type	Attribute Description
Date of Secondary Capture	(0018,1012)	3	Not used
Time of Secondary Capture	(0018,1014)	3	Not used

7. BASIC DIRECTORY INFORMATION OBJECT IMPLEMENTATION

7.1 INTRODUCTION

This section specifies the use of the DICOM Basic Directory IOD to represent the information included in directories produced by this implementation. Corresponding attributes are conveyed using the module construct. The contents of this section are:

7.2 - IOD Implementation

7.3 - IOD Entity-Relationship Model

7.4 - IOD Module Table

7.5 - IOD Module Definition

7.2 BASIC DIRECTORY IOD IMPLEMENTATION

This section defines the implementation of Basic Directory information object.

7.3 BASIC DIRECTORY ENTITY-RELATIONSHIP MODEL

The Entity-Relationship diagram for the Basic Directory interoperability schema is shown in Illustration 7.3-1. In this figure, the following diagrammatic convention is established to represent the information organization:

- each entity is represented by a rectangular box
- each relationship is represented by a diamond shaped box
- the fact that a relationship exists between two entities is depicted by lines connecting the corresponding entity boxes to the relationship boxes.

7.3.1 EchoPAC Mapping of DICOM entities

TABLE 7.3-1
MAPPING OF DICOM ENTITIES TO ECHO PAC ENTITIES

DICOM	EchoPAC
Patient	Patient
Study	Exam
Series	Exam
Image	Image

ILLUSTRATION 7.3-1
BASIC DIRECTORY ENTITY RELATIONSHIP DIAGRAM

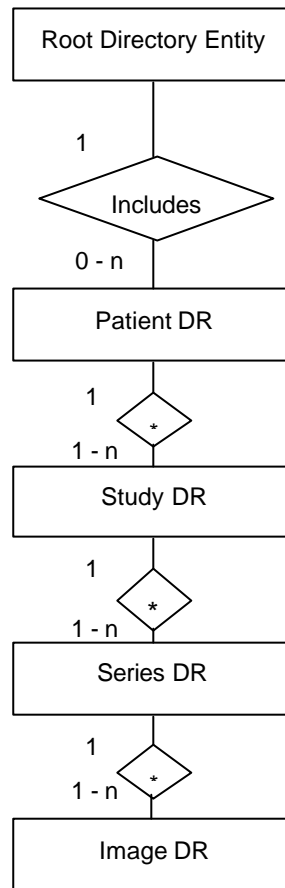

7.4 IOD MODULE TABLE

Within an entity of the Basic Directory IOD, attributes are grouped into related set of attributes. A set of related attributes is termed a module. A module facilitates the understanding of the semantics concerning the attributes and how the attributes are related with each other. A module grouping does not infer any encoding of information into datasets.

Table 7.4-1 identifies the defined modules within the entities, which comprise the Basic Directory IOD. Modules are identified by Module Name.

See DICOM v3.0 Part 3 for a complete definition of the entities, modules, and attributes.

TABLE 7.4-1
BASIC DIRECTORY IOD MODULES

Entity Name	Module Name	Reference
File Set Identification	File Set Identification	7.5.1.1
Directory Information	Directory Information	7.5.2.1

The Directory Information Module is created if it does not already exist on the storage media. If it already exists, the existing information is not changed regarding patient, study, series or image data.

An existing Directory Information Module may have been obtained from application entities using removable media. These instances are external to this conformance claim and the origin of the SOP instances is outside the scope of this claim.

7.5 INFORMATION MODULE DEFINITIONS

Please refer to DICOM v3.0 Standard Part 3 (Information Object Definitions) for a description of each of the entities and modules contained within the Basic Directory Information Object.

The following modules are included to convey Enumerated Values, Defined Terms, and Optional Attributes supported. Type 1 & Type 2 Attributes are also included for completeness and to define what values they may take and where these values are obtained. It should be noted that they are the same ones as defined in the DICOM v3.0 Standard Part 3 (Information Object Definitions).

7.5.1 Common File Set identification Modules

7.5.1.1 File Set identification Module

TABLE 7.5-1
FILE-SET IDENTIFICATION MODULE

Attribute Name	Tag	Type	Attribute Description
File-set ID	(0004,1130)	2	Has NULL value
File-set Descriptor File ID	(0004,1141)	3	Not used
Specific Character Set of File-set Descriptor File	(0004,1142)	1C	Not used

7.5.2 Common Directory Information Modules

7.5.2.1 Directory Information Module

TABLE 7.5-2
DIRECTORY INFORMATIONMODULE

Attribute Name	Tag	Type	Attribute Description
Offset of the First Directory Record of the Root Directory Entity	(0004,1200)	1	Is set

Attribute Name	Tag	Type	Attribute Description
Offset of the Last Directory Record of the Root Directory Entity	(0004,1202)	1	Is set
File-set Consistency Flag	(0004,1212)	1	FSC/FSU: Has the value 0000H: no known inconsistencies
Directory Record Sequence	(0004,1220)	2	Is created by FSC
>Offset of the Next Directory Record	(0004,1400)	1C	Is set
>Record In-use Flag	(0004,1410)	1C	FSC/FS: Is set to FFFFH FSR: A value of 0000H: imply skipping this record Import: A value of 0000H: the record is skipped
>Offset of Referenced Lower-Level Directory Entity	(0004,1420)	1C	Is set
>Directory Record Type	(0004,1430)	1C	The values supported by FSC and FSU are PATIENT STUDY SERIES IMAGE
>Private Record UID	(0004,1432)	1C	Not used
>Referenced File ID	(0004,1500)	1C	Is set if Directory Record Type is IMAGE Contains 1 to 3 elements: The first is Patient name (if not NULL) Exam date (if not NULL) <modality>+<incremental number> The elements are: - truncated to 8 characters - mapped to upper case characters - illegal characters are mapped to underscore _
>MRDR Directory Record Offset	(0004,1504)	1C	A MRDR is not created by an FSC or FSU.
>Referenced SOP Class UID in File	(0004,1510)	1C	Is set to the SOP class UID in File

Attribute Name	Tag	Type	Attribute Description
>Referenced SOP Instance UID in File	(0004,1511)	1C	Is set to the SOP instance UID in File
>Referenced Transfer Syntax UID in File	(0004,1512)	1C	Is set to the Transfer Syntax UID in File
>Record Selection Keys			See 7.5.3.

7.5.3 Definition of Specific Directory Records

7.5.3.1 Patient Directory Record Definition

TABLE 7.5-3
PATIENT KEYS

Key	Tag	Type	Attribute Description
Specific Character Set	(0008,0005)	1C	Is set if ISO IR 100 if extended characters are used in the message
Patient's Name	(0010,0010)	2	Is filled in by FSC and FSU, is a copy of the tag in the message stored to DicomDIR. If this value is found then it is used by the FSR when importing images. If not, the first image file is used for input.
Patient ID	(0010,0020)	1	Is filled in by FSC and FSU (where it may be Type 2), is a copy of the tag in the message stored to DicomDIR.
Patient's Birth Date	(0010,0030)	3	FSC/FSU: Is a copy of the tag in the message stored to DicomDIR.
Patient Comments	(0010,4000)	3	FSC/FSU Is a copy of the tag in the message stored to DicomDIR
Patient's Sex	(0010,0040)	3	FSC/FSU: Is a copy of the tag in the message stored to DicomDIR

7.5.3.2 Study Directory Record Definition

TABLE 7.5-4
STUDY KEYS

Key	Tag	Type	Attribute Description
Specific Character Set	(0008,0005)	1C	Is filled in by FSC or FSU as contained in the image message, if one of the tags contains extended characters

Key	Tag	Type	Attribute Description
Study Date	(0008,0020)	1	Is filled in by FSC or FSU as contained in the image message
Study Time	(0008,0030)	1	Is filled in by FSC or FSU as contained in the image message. If not found, then a time of 00.00.00 is filled in
Study Description	(0008,1030)	2	Is filled in by FSC or FSU as contained in the image message. If not NULL value is set
Study Instance UID	(0020,000D)	1C	Is filled in by FSC or FSU as contained in the image message. If not update of DICOM is refused
Study ID	(0020,0010)	1	Is filled in by FSC or FSU as contained in the image message. If not it is created from Study Time.
Accession Number	(0008,0050)	2	Is filled in by FSC or FSU if it is contained in the image message. If not a NULL value is set. Used by FSR if found in the message.

7.5.3.3 Series Directory Record Definition

TABLE 7.5-5
SERIES KEYS

Key	Tag	Type	Attribute Description
Specific Character Set	(0008,0005)	1C	Is filled in by FSC or FSU as contained in the image message, if one of the tags contains extended characters
Modality	(0008,0060)	1	Only "US" is created by FSC and FSU. FSR uses this value to check if this is a supported series. If value is not "US" then the series is not displayed or imported.
Series Instance UID	(0020,000E)	1	As contained in the image message. If not update of DICOMDIR is refused

Key	Tag	Type	Attribute Description
Series Number	(0020,0011)	1	Is filled in by FSC or FSU using the value found in the message if it is contained in the image message. If not found in the message, then an incremental value is used, incremented by 1 for each series within the study. Used by FSR if found in the message.
Icon Image Sequence	(0088,0200)	3	Not used.
Series Description	(0008,103E)	3	Is filled in by FSC or FSU as contained in the image message
Series Date	(0008,0021)	3	Is filled in by FSC or FSU as contained in the image message
Series Time	(0008,0031)	3	Is filled in by FSC or FSU as contained in the image message
Series Description	(0008,103E)	3	Is filled in by FSC or FSU as contained in the image message

7.5.3.4 Image Directory Record Definition

TABLE 7.5-6
IMAGE KEYS

Key	Tag	Type	Attribute Description
Specific Character Set	(0008,0005)	1C	Is filled in by FSC or FSU as contained in the image message, if one of the tags contains extended characters
Image Number	(0020,0013)	1	Is filled in by FSC or FSU using the value found in the message as contained in the image message. If not found in the message, then an incremental value is used, incremented by 1 for each image within the series. Used by FSR if found in the message
Icon Image Sequence	(0088,0200)	3	Not used
Image Date	(0008,0023)	3	Is filled in by FSC or FSU as contained in the image message
Image Time	(0008,0033)	3	Is filled in by FSC or FSU as contained in the image message

Image Type	(0008,0008)	3	Is filled in by FSC or FSU as contained in the image message
Rows	(0028,0010)	3	Is filled in by FSC or FSU as contained in the image message
Columns	(0028,0011)	3	Is filled in by FSC or FSU as contained in the image message
Number Of Frames	(0028,0008)	3	Is filled in by FSC or FSU as contained in the image message
Photometric Interpretation	(0028,0004)	3	Is filled in by FSC or FSU as contained in the image message
Referenced Transfer Syntax UID in File	(0004,1512)	3	Is filled in by FSC or FSU as contained in the image message
Referenced SOP Instance UID in File	(0004,1511)	3	Is filled in by FSC or FSU as contained in the image message
Referenced SOP Class in File	(0004,1510)	3	Is filled in by FSC or FSU as contained in the image message

7.5.3.4.1 Private Directory Record Definition

Not used.

7.5.3.5 Multi-Referenced File Directory Record Definition

Not used.

7.6 PRIVATE DATA DICTIONARY

Not used.

8. PRINT MANAGEMENT SOP CLASS DEFINITION

8.1 INTRODUCTION

This section of the DICOM Conformance Statement specifies the supported Print Management SOP and Meta SOP Classes, the optional attributes and service elements supported, the valid range of values for mandatory and optional attributes, and the status code behavior.

8.2- Basic Print Management Meta SOP Classes

8.3- Print Management SOP Class Definitions

8.4- Print Management IODs

8.5- IOD Module Definition

8.2 BASIC PRINT MANAGEMENT META SOP CLASSES

The Basic Print Management Meta SOP Classes correspond with the minimum functionality that an implementation of the Print Management Service Class shall support.

EchoPAC supports the Basic Grayscale Print Management Meta SOP Class and the Basic Color Print Management Meta SOP Class. These are defined in Table 8.2.1-1 and Table 8.2.2-1.

8.2.1 Basic Grayscale Print Management Meta SOP Class

The Basic Grayscale Print Management Meta SOP Class is defined by the following set of supported SOP Classes.

TABLE 8.2.1-1 BASIC GRAYSCALE PRINT MANAGEMENT META SOP CLASS

SOP Class Name	Usage SCU	Reference
Basic Film Session SOP Class	M	see 8.3.1
Basic Film Box SOP Class	M	see 8.3.2
Basic Grayscale Image Box SOP Class	M	see 8.3.3.1
Printer SOP Class	M	see 8.3.4

8.2.2 Basic Color Print Management Meta SOP Class

The Basic Color Print Management Meta SOP Class is defined by the following set of supported SOP Classes

TABLE 8.2.2-1 BASIC COLOR PRINT MANAGEMENT META SOP CLASS

SOP Class Name	Usage SCU	Reference
Basic Film Session SOP Class	M	see 8.3.1
Basic Film Box SOP Class	M	see 8.3.2
Basic Color Image Box SOP Class	M	see 8.3.3.2
Printer SOP Class	M	see 8.3.4

8.3 PRINT MANAGEMENT SOP CLASS DEFINITIONS

8.3.1 Basic Film Session SOP Class

The Basic Film Session IOD describes the presentation parameters, which are common for all the films of a film session. The DIMSE services that are applicable to the IOD are shown in Table 8.3.1-1.

TABLE 8.3.1-1 DIMSE SERVICE GROUP

DIMSE Service Element	Usage SCU	Reference
N-CREATE	M	see 8.3.1.1.1
N-SET	U	see 8.3.1.1.2
N-DELETE	U	see 8.3.1.1.3
N-ACTION	U	see 8.3.1.1.4

8.3.1.1 DIMSE Service Group

8.3.1.1.1 N-CREATE

The N-CREATE DIMSE Service is used by the EchoPAC to request that the SCP (printer) create a Film Session SOP Instance. Table 8.4.2-1 defines the Basic Film Session Presentation Module attributes used in this request.

8.3.1.1.2 N-SET

Not used in this implementation.

8.3.1.1.3 N-DELETE

Not used in this implementation.

8.3.1.1.4 N-ACTION

Not used in this implementation

8.3.2 Basic Film Box SOP Class

The Basic Film Box IOD is an abstraction of the presentation of one film of the film session. The DIMSE services that are applicable to the IOD are shown in Table 8.3.2-1.

TABLE 8.3.2-1 DIMSE SERVICE GROUP

DIMSE Service Element	Usage SCU	Reference
N-CREATE	M	see 8.3.2.1.1
N-ACTION	M	see 8.3.2.1.2
N-DELETE	U	see 8.3.2.1.3
N-SET	U	see 8.3.2.1.4

8.3.2.1 DIMSE Service Group

8.3.2.1.1 N-CREATE

The N-CREATE DIMSE Service is used by the EchoPAC to request that the SCP create a Film Box SOP Instance. Table 8.4.2-1 defines the Basic Film Box Presentation Module attributes used in this request.

8.3.2.1.2 N-ACTION

The N-ACTION DIMSE Service is used by the EchoPAC to request the SCP (printer) to print the number of copies configured by the user to a film of the film session.

8.3.2.1.3 N-DELETE

The N-DELETE DIMSE Service is used by the EchoPAC to request the SCP (printer) to delete the complete Film Box. The root Film Box Instance UID is sent to the SCP to accomplish this.

8.3.2.1.4 N-SET

Not used in this implementation.

8.3.3 Image Box SOP Class

8.3.3.1 Basic Grayscale Image Box SOP Class

The Basic Grayscale Image Box IOD is an abstraction of the presentation of an image and image related data in the image area of a film. The DIMSE services that are applicable to the IOD are shown in Table 8.3.3-1.

TABLE 8.3.3-1 DIMSE SERVICE GROUP

DIMSE Service Element	Usage SCU	Reference
N-SET	M	see 8.3.3.1.1

8.3.3.1.1 DIMSE Service Group (N-SET)

The N-SET DIMSE Service is used by the EchoPAC to update the Basic Grayscale Image Box SOP Instance. Table 8.5.2-5 defines the Basic Image Box Presentation Module attributes used.

8.3.3.2 Basic Color Image Box SOP Class

The Basic Color Image Box IOD is an abstraction of the presentation of an image and image related data in the image area of a film. The DIMSE services that are applicable to the IOD are shown in Table 8.3.3-2.

TABLE 8.3.3-2 DIMSE SERVICE GROUP

DIMSE Service Element	Usage SCU	Reference
N-SET	M	see 8.3.3.2.1

8.3.3.2.1 DIMSE Service Group (N-SET)

The N-SET DIMSE Service is used by the EchoPAC to update the Basic Color Image Box SOP Instance. Table 8.5.2-5 defines the Basic Image Box Presentation Module attributes used.

8.3.4 Printer SOP Class

The Printer IOD is an abstraction of the hard copy printer and is the basic Information Entity to monitor the status of the printer. The DIMSE services that are applicable to the IOD are shown in table 8.3.4-1.

8.3.4.1 DIMSE Service Group**TABLE 8.3.4-1 DIMSE SERVICE GROUP**

DIMSE Service Element	Usage SCU	Reference
N-EVENT-REPORT	M	see 8.3.4.1.1
N-GET	U	see 8.3.4.1.2

8.3.4.1.1 N-EVENT_REPORT

The EchoPAC confirms the N-EVENT-REPORT initiated by the SCP (printer).

8.3.4.1.2 N-GET

Used by the EchoPAC to request the SCP to get a Printer SOP Instance. Table 8.5.2-6 defines the Printer Module attributes.

8.4 PRINT MANAGEMENT IODS

Within an entity of a DICOM v3.0 Print Management, attributes are grouped into a related set of attributes. A set of related attributes is termed a module. A module facilitates the understanding of the semantics concerning the attributes and how the attributes are related with each other. A module grouping does not infer any encoding of information into datasets.

Table 8.4.1-1, Table 8.4.2-1, Table 8.4.3-1, and Table 8.4.4-1 identify the defined modules within the entities which comprise the DICOM v3.0 Print Management Service IODs. Modules are identified by Module Name.

See DICOM v3.0 for a complete definition of the entities, modules and attributes.

8.4.1 Film Session IOD Module

TABLE 8.4.1-1 FILM SESSION IOD MODULES

Module Name	Reference	Module Description
SOP Common Module	8.5.2.1	Contains SOP Common information
Basic Film Session Presentation Module	8.5.2.1	Contains Film Session presentation information
Basic Film Session Relationship Module	8.5.2.2	References to related SOPs

8.4.2 Basic Film Box IOD Module Table

TABLE 8.4.2-1 BASIC FILM BOX IOD MODULES

Module Name	Reference
SOP Common Module	8.5.1.1
Basic Film Box Presentation Module	8.5.2.3
Basic Film Box Relationship Module	8.5.2.2

8.4.3 Basic Image Box IOD Module Table

TABLE 8.4.3-1 BASIC IMAGE BOX IOD MODULES

Module Name	Reference
SOP Common Module	8.5.1.1
Image Box Pixel Presentation Module	8.5.2.5
Image Box Relationship Module	not used

8.4.4 Printer IOD Module Table

TABLE 8.4.4-1 PRINTER IOD MODULES

Module Name	Reference
SOP Common Module	8.5.1.1
Printer Module	8.5.2.6

8.5 INFORMATION MODULE DEFINITIONS

Please refer to DICOM v3.0 Standard Part 3 (Information Object Definitions) for a description of each of the entities and modules that comprise the Print Management.

The following modules are included to convey Enumerated Values, Defined Terms, and Optional Attributes supported.

8.5.1 General Modules

8.5.1.1 SOP Common Module

This section defines the attributes that are required for proper functioning and identification of the associated SOP Instances. They do not specify any semantics about the Real-World Object represented by the IOD.

TABLE 8.5.1-1 SOP COMMON MODULE ATTRIBUTES

Attribute Name	Tag	Type	Attribute Description
SOP Class UID	(0008,0016)	1	Varies with Module Instance and DIMSE Service being used. 1.2.840.10008.5.1.1.1 (Film Session) 1.2.840.10008.5.1.1.2 (Film Box) 1.2.840.10008.5.1.1.4 (Image Box)
SOP Instance UID	(0008,0018)	1	Provided by SCP (printer).
Specific Character Set	(0008,0005)	1C	Not used as expanded or replacement character sets not used.
Instance Creation Date	(0008,0012)	3	Not used.
Instance Creation Time	(0008,0013)	3	Not used.
Instance Creator UID	(0008,0014)	3	Not used.

8.5.2 Print Management Modules

8.5.2.1 Basic Film Session Presentation Module

This section defines the attributes that are common for all films of a film session. The attributes described in table 8.5.2-1 apply when the N-CREATE DIMSE service is used.

TABLE 8.5.2-1 BASIC FILM SESSION PRESENTATION MODULE ATTRIBUTES

Attribute Name	Tag	USAGE (SCU)	Attribute Description
Number of Copies	(2000,0010)	U	Defined Terms used (user configurable): Default is 1.
Print Priority	(2000,0020)	U	Defined Terms used (user configurable): H – High, M – Medium or L – Low. Default is M – Medium.
Medium Type	(2000,0030)	U	Defined Terms used (user configurable): PAPER BLUE FILM CLEAR FILM Default is CLEAR FILM.
Film Destination	(2000,0040)	U	Defined Terms used (user configurable): MAGAZINE - default PROCESSOR
Film Session Label	(2000,0050)	U	Entered in the User Interface. No default.
Memory Allocation	(2000,0060)	U	Not Used

8.5.2.2 Basic Film Session Relationship Module

TABLE 8.5.2-2 BASIC FILM SESSION RELATIONSHIP MODULE ATTRIBUTES

Attribute Name	Tag	USAGE (SCU)	Attribute Description
Referenced Film Box Sequence	(2000,0500)	U	Not used
>Referenced SOP Class UID	(0008,1150)	U	
>Referenced SOP Instance UID	(0008,1155)	U	

8.5.2.3 Basic Film Box Presentation Module

The attributes described in table 8.5.2-3 apply when the N-CREATE DIMSE service is used.

TABLE 8.5.2-3 BASIC FILM BOX PRESENTATION MODULE ATTRIBUTES

Attribute Name	Tag	USAGE (SCU)	Attribute Description
Image Display Format	(2010,0010)	U	Enumerated values used (user configurable): STANDARD\X,Y Where X and Y can take any value in the range 1-5. Default is STANDARD\1,1
Annotation Display Format ID	(2010,0030)	U	Sent as zero length.
Film Orientation	(2010,0040)	U	Defined Terms used (user configurable): PORTRAIT - default LANDSCAPE
Film Size ID	(2000,0050)	U	Defined Terms used(user configurable) : 8INX10IN - default 10INX12IN 10INX14IN 11INX14IN 14INX14IN 14INX17IN 24CMX24CM 24CMX30CM
Magnification Type	(2010,0060)	U	Defined Terms Used (user configurable) : REPLICATE - default BILINEAR CUBIC NONE
Smoothing Type	(2010,0080)	U	Free form text entry field and only sent if Magnification Type is Cubic. No default
Border Density	(2010,0100)	U	Defined Terms Used (user configurable): BLACK WHITE Default is BLACK.

Empty Image Density	(2010,0110)	U	Defined Terms Used (user configurable): BLACK WHITE Default is WHITE.
Min Density	(2010,0120)	U	Entered in the User Interface. No default.
Max Density	(2010,0130)	U	Entered in the User Interface. No default.
Trim	(2010,0140)	U	Enumerated Values Used: YES NO Default is NO.
Configuration Information	(2010,0150)	U	Entered in the User Interface. No default.

8.5.2.4 Basic Film Box Relationship Module

This section defines the attributes that describe the common parameters, which apply for all images on a given sheet of film.

TABLE 8.5.2-4 BASIC FILM BOX RELATIONSHIP MODULE ATTRIBUTES

Attribute Name	Tag	USAGE (SCU)	Attribute Description
Referenced Film Session Sequence	(2010,0500)	U	
>Referenced SOP Class UID	(0008,1150)	U	1.2.840.10008.5.1.1.1
>Referenced SOP Instance UID	(0008,1155)	U	Provided by SCP (printer)
Referenced Image Box Sequence	(2010,0510)	U	Not used
>Referenced SOP Class UID	(0008,1150)	U	
>Referenced SOP Instance UID	(0008,1155)	U	
Referenced Basic Annotation Sequence	(2010,0520)	U	Not used
>Referenced SOP Class UID	(0008,1150)	U	
>Referenced SOP Instance UID	(0008,1155)	U	

8.5.2.5 Image Box Pixel Presentation Module

The attributes described in apply when the DIMSE Service N-SET is used.

TABLE 8.5.2-5 IMAGE BOX PIXEL PRESENTATION MODULE ATTRIBUTES

Attribute Name	Tag	USAGE (SCU)	Attribute Description
Image Position	(2020,0010)	M	Based on the image display format.
Polarity	(2020,0020)	U	Defined term, NORMAL
Requested Image Size	(2020,0030)	U	Not sent
Basic Grayscale Image Sequence	(2020,0110)	M	
>Samples Per Pixel	(0028,0002)	M	Value = '1'
>Photometric Interpretation	(0028,0004)	M	Defined Term MONOCHROME2 used
>Rows	(0028,0010)	M	Value depends on scanning mode and configuration setup.
>Columns	(0028,0011)	M	Value depends on scanning mode and configuration setup.
>Pixel Aspect Ratio	(0028,0034)	MC	Not sent
>Bits Allocated	(0028,0100)	M	Value always = 0008H
>Bits Stored	(0028,0101)	M	Value always = 0008H
>High Bit	(0028,0102)	M	Value always = 0007H
>Pixel Representation	(0028,0103)	M	Defined Value '0' - unsigned integer
>Pixel Data	(7FE0,0010)	M	
Basic Color Image Sequence	(2020,0111)	M	
>Samples Per Pixel	(0028,0002)	M	Value = '3'
>Photometric Interpretation	(0028,0004)	M	Defined Term RGB used
>Rows	(0028,0010)	M	Value depends on scanning mode and configuration setup.
>Columns	(0028,0011)	M	Value depends on scanning mode and configuration setup.
>Pixel Aspect Ratio	(0028,0034)	M	1\1
>Bits Allocated	(0028,0100)	M	Value always = 0008H
>Bits Stored	(0028,0101)	M	Value always = 0008H
>High Bit	(0028,0102)	M	Value always = 0007H
>Pixel Representation	(0028,0103)	M	Defined Value '0' - unsigned integer
>Pixel Data	(7FE0,0010)	M	
Planar Configuration	(0028, 0006)	M	0001H , color-by-plane ,when Basic Color Image Sequence is set

8.5.2.6 Printer Module

This section defines the attributes that are used to monitor the status of the printer. The attributes described in Table 8.5.2-6 apply when the DIMSE Service N-GET is used.

TABLE 8.5.2-6 PRINTER MODULE ATTRIBUTES

Attribute Name	Tag	USAG E (SCU)	Attribute Description
Printer Status	(2110,0010)	U	Used to check the status of the printer before a print operation is started. If the status is different from 0x0, Success the print operation is aborted, a message is displayed and the print files resides in the print buffer.
Printer Status Info	(2110,0020)	U	If return status is "FAILURE" an error message is displayed, and the print files resides in the print buffer.
Printer Name	(2110,0030)	U	Not used
Manufacturer	(0008,0070)	U	Not used
Manufacturer Model Name	(0008,1090)	U	Not used
Device Serial Number	(0018,1000)	U	Not used
Software Versions	(0018,1020)	U	Not used
Date Last Calibration	(0018,1200)	U	Not used
Last Calibration	(0018,1201)	U	Not used

9. MODALITY WORKLIST INFORMATION MODEL DEFINITION

9.1 INTRODUCTION

This section specifies the use of the DICOM Modality Worklist Information Model used to organize data and against which a Modality Worklist Query will be performed. The contents of this section are:

9.2- Information Model Description

9.3- Information Model Entity-Relationship Model

9.4- Information Model Module Table

9.5- Information Model Keys

9.2 MODALITY WORKLIST INFORMATION MODEL DESCRIPTION

This section defines the implementation of Modality worklist information model.

9.3 MODALITY WORKLIST INFORMATION MODEL ENTITY-RELATIONSHIP MODEL

The Entity-Relationship diagram for the Modality Worklist Information Model schema is shown in Illustration 0-2. It represents the information that composes a Worklist Item. In this figure, the following diagrammatic convention is established to represent the information organization:

- Each entity is represented by a rectangular box.
- Each relationship is represented by a diamond shaped box.
- The fact that a relationship exists between two entities is depicted by lines connecting the corresponding entity boxes to the relationship boxes.
- In the event that a duplicate Study Instance UID is received, only the last record of the duplicate will be displayed.

ILLUSTRATION 0-2
MODALITY WORKLIST INFORMATION MODEL E/R DIAGRAM

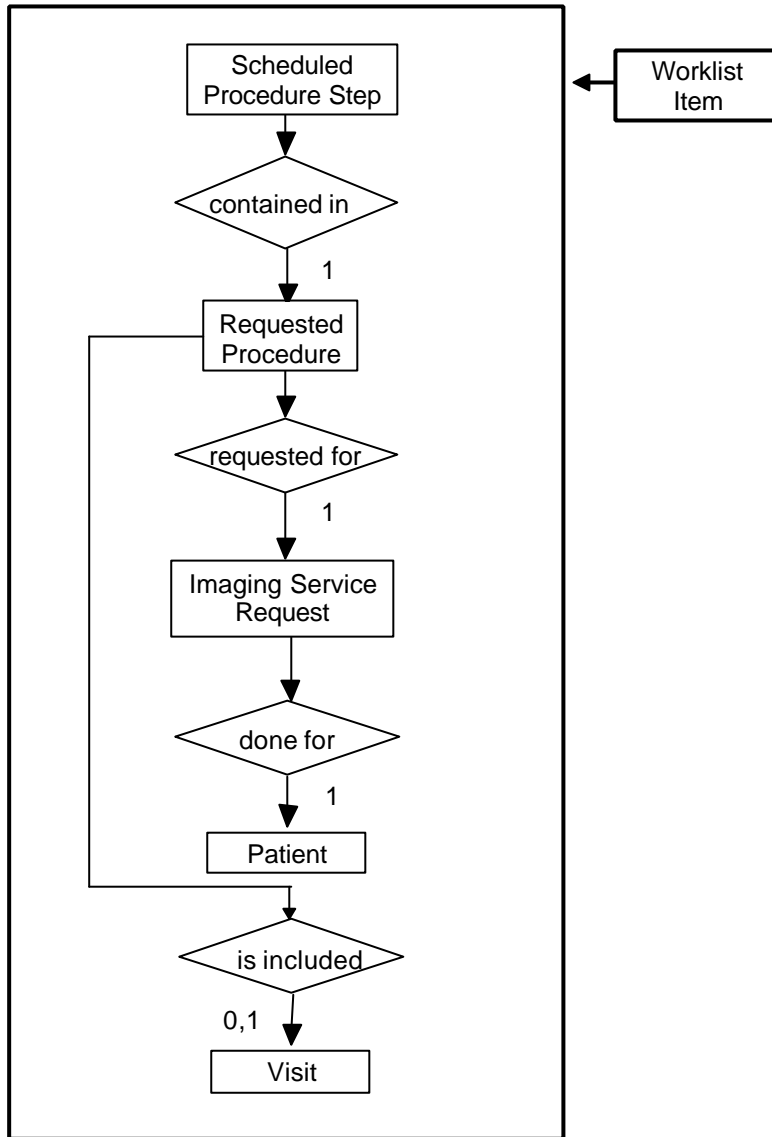

9.3.1 Entity Descriptions

Please refer to DICOM Standard PS 3.3. (Information Object Definitions) and PS 3.4 (Service Class Specifications) for a description of each of the Entities contained within the Modality Worklist Information Model.

9.3.1.1 Scheduled Procedure Step Entity Description

Schedule Procedure Step Entity is implemented in a basic form to allow for the user to retrieve a subset of attributes.

9.3.1.2 Requested Procedure Entity Description

Requested Procedure Entity is implemented in a basic form to allow for the user to retrieve a subset of attributes.

9.3.1.3 Imaging Service Request Entity Description

Imaging Service Request Entity is implemented in a basic form to allow for the user to retrieve a subset of attributes.

9.3.1.4 Visit Entity Description

Visit Entity is implemented in a basic form to allow for the user to retrieve a subset of attributes.

9.3.1.5 Patient Entity Description

Patient Entity is implemented in a basic form to allow for the user to retrieve a subset of attributes.

9.3.2 EchoPAC Mapping of DICOM entities

**TABLE 9.3-1
MAPPING OF DICOM ENTITIES TO ECHO PAC ENTITIES**

DICOM	EchoPAC Entity
Scheduled Procedure Step	Exam
Requested Procedure	Exam
Imaging Service Request	Exam
Visit	Exam
Patient	Patient

9.4 INFORMATION MODEL MODULE TABLE

Within an entity of the DICOM v3.0 Modality Worklist Information Model, attributes are grouped into related set of attributes. A set of related attributes is termed a module. A module facilitates the understanding of the semantics concerning the attributes and how the attributes are related with each other. A module grouping does not infer any encoding of information into datasets.

Table 9.4-1 identifies the defined modules within the entities that comprise the DICOM v3.0 Modality Worklist Information Model. Modules are identified by Module Name.

See DICOM v3.0 PS 3.3 and PS 3.4 for a complete definition of the entities, modules, and attributes.

**TABLE 9.4-1
MODALITY WORKLIST INFORMATION MODEL MODULES**

Entity Name	Module Name	Reference
Scheduled Procedure Step	SOP Common	9.5.2.1
	Scheduled Procedure Step	9.5.2.2
Requested Procedure	Requested Procedure	9.5.3.1
Imaging Service Request	Imaging Service Request	9.5.4.1
Visit	Visit Identification	9.5.5.1
	Visit Status	9.5.5.2
	Visit Relationship	9.5.5.3
	Visit Admission	9.5.5.4
Patient	Patient Relationship	9.5.6.1
	Patient Identification	9.5.6.3
	Patient Demographic	9.5.6.3
	Patient Medical	9.5.6.4

9.5 INFORMATION MODEL KEYS

Please refer to DICOM Standard PS 3.3. (Information Object Definitions) and PS 3.4 (Service Class Specifications) for a description of each of the Entities contained within the Modality Worklist Information Model.

The following Module descriptions are included to specify what data elements are supported and what type of matching can be applied. It should be noted that they are the same ones as defined in the DICOM v3.0 Standard PS 3.4 (Service Class Specifications).

9.5.1 Supported Matching

Following are the types of matching that can be requested by the implementation:

- Single Value Matching.
- Wild Card Matching.
- Range of date.

Note: Wild card matching is implemented so that EchoPAC by default always append a wild card at the end of the text for the attributes listed with wild card matching in the tables below.

9.5.2 Scheduled Procedure Step Entity

9.5.2.1 SOP Common Module

TABLE 9.5-1
SOP COMMON MODULE ATTRIBUTES

Attribute Name	Tag	Expected Matching Key Type	Expected Returned Key Type	Mapped into the Image	Matching
Specific Character Set	(0008,0005)	O	1C	Yes	Matching is supported if the query contains matching keys in other than the default character repertoire.

9.5.2.2 Scheduled Procedure Step Module

TABLE 9.5-2
SCHEDULED PROCEDURE STEP MODULE ATTRIBUTES

Attribute Name	Tag	Expected Matching Key Type	Expected Returned Key Type	Mapped into the Image	Matching
Scheduled Procedure Step Sequence	(0040,0100)	R	1	No	Matching is supported through following tags in sequence.
>Scheduled Station AE Title	(0040,0001)	R	1	No	Matching is supported. This field is dynamically entered by the user. Default is local AE Title.
>Scheduled Procedure Step Start Date	(0040,0002)	R	1	No	Matching is supported. This field is dynamically entered by the user. Range is supported through the user interface.
>Scheduled Procedure Step Start Time	(0040,0003)	R	1	No	Matching is supported. This field is dynamically entered by the user.
>Modality	(0008,0060)	R	1	Yes, but always "US".	Matching is supported. This field is dynamically entered by the user. Default is "US".
>Scheduled Performing Physician's Name	(0040,0006)	R	2	Yes	Matching is supported. This field is dynamically entered by the user. Wild card matching is supported.
>Scheduled Procedure Step Description	(0040,0007)	O	1C	No	Matching is supported. This field is dynamically entered by the user.
>Scheduled Station Name	(0040,0010)	O	2	No	Matching is supported. This field is dynamically entered by the user. Default is local Station Name.

>Scheduled Procedure Step Location	(0040,0011)	O	2	No	Matching is supported. This field is dynamically entered by the user.
>Requested Contrast Agent	(0032,1070)	O	2C	No	Always empty.
>Scheduled Procedure Step ID	(0040,0009)	O	1	No	Always empty.
>Scheduled Procedure Step End Date	(0040,0004)	O	3	No	Always empty.
>Scheduled Procedure Step End Time	(0040,0005)	O	3	No	Always empty.

9.5.3 Requested Procedure Entity**9.5.3.1 Requested Procedure Module****TABLE 9.5-3****REQUESTED PROCEDURE MODULE ATTRIBUTES**

Attribute Name	Tag	Expected Matching Key Type	Expected Returned Key Type	Mapped into the Image	Matching
Requested Procedure ID	(0040,1001)	O	1	Yes	Matching is supported. This field is dynamically entered by the user.
Requested Procedure Description	(0032,1060)	O	1C	Yes	Matching is supported. This field is dynamically entered by the user.
Requested Procedure Code Sequence	(0032,1064)	O	1C	No	Always empty.
Study Instance UID	(0020,000D)	O	1	Yes	Always empty.
Referenced Study Sequence	(0008,1110)	O	2	Yes	Always empty.
Names of Intended Recipients of Results	(0040,1010)	O	3	Yes	Always empty.

9.5.4 Imaging Service Request Entity**9.5.4.1 Imaging Service Request Module**

**TABLE 9.5-4
IMAGING SERVICE REQUEST MODULE ATTRIBUTES**

Attribute Name	Tag	Expected Matching Key Type	Expected Returned Key Type	Mapped into the Image	Matching
Accession Number	(0008,0050)	O	2	Yes	Matching is supported. This field is dynamically entered by the user.
Referring Physician's Name	(0008,0090)	O	2	Yes	Always empty.
Requesting Physician	(0032,1032)	O	2	No	Always empty.
Imaging Service Request Comments	(0040,2400)	O	3	No	Always empty.
Requesting Service	(0032,1033)	O	3	No	Always empty.

9.5.5 Visit Entity**9.5.5.1 Visit Identification**

**TABLE 9.5-5
VISIT IDENTIFICATION MODULE ATTRIBUTES**

Attribute Name	Tag	Expected Matching Key Type	Expected Returned Key Type	Mapped into the Image	Matching
Admission ID	(0038,0010)	O	2	No	Matching is supported. This field is dynamically entered by the user.
Institution Name	(0008,0080)	O	3	No	Always empty.

9.5.5.2 Visit Status

**TABLE 9.5-6
VISIT STATUS MODULE ATTRIBUTES**

Attribute Name	Tag	Expected Matching Key Type	Expected Returned Key Type	Mapped into the Image	Matching
Current Patient Location	(0038,0300)	O	2	No	Always empty.

9.5.5.3 Visit Relationship

TABLE 9.5-7

VISIT RELATIONSHIP MODULE ATTRIBUTES

Attribute Name	Tag	Expected Matching Key Type	Expected Returned Key Type	Mapped into the Image	Matching
Referenced Patient Sequence	(0008,1120)	O	2	Yes	Always empty.
Referenced Study Sequence	(0008,1110)	O	3	Yes	Always empty.

9.5.5.4 Visit Admission

TABLE 9.5-8

VISIT ADMISSION MODULE ATTRIBUTES

Attribute Name	Tag	Expected Matching Key Type	Expected Returned Key Type	Mapped into the Image	Matching
Admitting Diagnosis Description	(0008,1080)	O	3	No	Always empty.
Referring Physician's Name	(0008,0090)	O	3	No	Always empty.

9.5.6 Patient Entity

9.5.6.1 Patient Relationship Module

TABLE 9.5-9

PATIENT RELATIONSHIP MODULE ATTRIBUTES

Attribute Name	Tag	Expected Matching Key Type	Expected Returned Key Type	Mapped into the Image	Matching
Referenced Study Sequence	(0008,1110)	O	3	No	Always empty.

9.5.6.2 Patient Identification

TABLE 9.5-10
PATIENT IDENTIFICATION MODULE ATTRIBUTES

Attribute Name	Tag	Expected Matching Key Type	Expected Returned Key Type	Mapped into the Image	Matching
Patient's Name	(0010,0010)	R	1	Yes	Matching is supported. This field is dynamically entered by the user. Wild card matching is supported.
Patient ID	(0010,0020)	R	1	Yes	Matching is supported. This field is dynamically entered by the user.
Other Patient Ids	(0010,1000)	O	3	Yes	Always empty.
Other Patient Names	(0010,1001)	O	3	Yes	Always empty.

9.5.6.3 Patient Demographic

TABLE 9.5-11
PATIENT DEMOGRAPHIC MODULE ATTRIBUTES

Attribute Name	Tag	Expected Matching Key Type	Expected Returned Key Type	Mapped into the Image	Matching
Patients Birth Date	(0010,0030)	O	2	Yes	Matching is supported. This field is dynamically entered by the user.
Patient's Sex	(0010,0040)	O	2	Yes	Matching is supported. This field is dynamically entered by the user.
Patient's Size	(0010,1020)	O	3	Yes	Always empty.
Patient's Weight	(0010,1030)	O	2	Yes	Always empty.
Patient's Address	(0010,1040)	O	3	No	Always empty.
Patient's Telephone Numbers	(0010,2154)	O	3	No	Always empty.
Ethnic Group	(0010,2160)	O	3	Yes	Always empty.
Patient Comments	(0010,4000)	O	3	Yes	Always empty.
Patient's Birth Time	(0010,0032)	O	3	No	Always empty.

GE MEDICAL SYSTEMS

CONFORMANCE STATEMENT

DIRECTION 2256472-100 REV 4

Patient's Age	(0010,1010)	O	3	No	Always empty.
Occupation	(0010,2180)	O	3	No	Always empty.

9.5.6.4 Patient Medical

**TABLE 9.5-12
PATIENT MEDICAL MODULE ATTRIBUTES**

Attribute Name	Tag	Expected Matching Key Type	Expected Returned Key Type	Mapped into the Image	Matching
Pregnancy Status	(0010,21C0)	O	2	No	Always empty.
Medical Alerts	(0010,2000)	O	2	No	Always empty.
Contrast Allergies	(0010,2110)	O	2	No	Always empty.
Special Needs	(0038,0050)	O	2	No	Always empty.
Smoking Status	(0010,21A0)	O	2	No	Always empty.
Additional Patient History	(0010,21B0)	O	3	Yes	Always empty.

10. MODALITY PERFORMED PROCEDURE STEP SOP CLASS DEFINITION

10.1 INTRODUCTION

This section of the DICOM Conformance Statement specifies the Modality Performed Procedure Step SOP Class, the optional attributes and service elements supported, the valid range of values for mandatory and optional attributes, and the status code behavior.

10.2 MODALITY PERFORMED PROCEDURE STEP SOP CLASS DEFINITION

10.2.1 IOD Description

This is the description of the DICOM tags to be sent for Modality Performed Procedure Step SOP class:

Modality Performed Procedure Step Sop Class N-CREATE, N-SET and Final State

Attributes

Attribute Name	Tag	Req. Type N-CREATE	Req. Type N-SET
Performed Procedure Step Relationship			
Scheduled Step Attribute Sequence	(0040,0270)	1	Not allowed
>Study Instance UID	(0020,000D)	1	Not allowed
>Accession Number	(0008,0050)	2, supported	Not allowed
>Requested Procedure ID	(0040,1001)	2, supported	Not allowed
>Requested Procedure Description	(0032,1060)	2, supported	Not allowed
>Scheduled Procedure Step ID	(0040,0009)	2, supported	Not allowed
>Scheduled Procedure Step Description	(0040,0007)	2, supported	Not allowed
Patient's Name	(0010,0010)	2, supported	Not allowed
Patient ID	(0010,0020)	2, supported	Not allowed
Patient's Birth Date	(0010,0032)	2, supported	Not allowed
Patient's Sex	(0010,0040)	2, supported	Not allowed
Performed Procedure Step Information			
Performed Procedure Step ID	(0040,0253)	1	Not allowed
Performed Station AE Title	(0040,0241)	1	Not allowed
Performed Station Name	(0040,0242)	2, supported	Not allowed

Attribute Name	Tag	Req. Type N-CREATE	Req. Type N-SET
Performed Location	(0040,0243)	2, supported (Institution Name)	Not allowed
Performed Procedure Step Start Date	(0040,0244)	1	Not allowed
Performed Procedure Step Start Time	(0040,0245)	1	Not allowed
Performed Procedure Step Status	(0040,0252)	1	3, supported
Performed Procedure Step Description	(0040,0254)	2, always empty	3, not supported
Performed Procedure Type Description	(0040,0255)	2, always empty	3, not supported
Procedure Code Sequence	(0008,1032)	2, always empty	3, not supported
>Code Value	(0008,0100)	1C (Required if Sequence Item is present)	1C (Required if Sequence Item is present)
>Coding Scheme Designator	(0008,0102)	1C (Required if Sequence Item is present)	1C (Required if Sequence Item is present)
>Code Meaning	(0008,0104)	3	3
Performed Procedure Step End Date	(0040,0250)	2, always empty	3, not supported
Performed Procedure Step End Time	(0040,0251)	2, always empty	3, not supported
Image Acquisition Results			
Modality	(0008,0060)	1	Not allowed
Study ID	(0020,0010)	2, supported	Not allowed
Performed Series Sequence	(0040,0340)	2, always empty	3, supported
>Performing Physician's Name	(0008,1050)	2C (Required if Sequence Item is present)	2C (Required if Sequence Item is present)
>Protocol Name	(0018,1030)	1C (Required if Sequence Item is present)	1C (Required if Sequence Item is present)

Attribute Name	Tag	Req. Type N-CREATE	Req. Type N-SET
>Operator's Name	(0008,1070)	2C (Required if Sequence Item is present)	2C (Required if Sequence Item is present)
>Series Instance UID	(0020,000E)	1C (Required if Sequence Item is present)	1C (Required if Sequence Item is present)
>Series Description	(0008,103E)	2C (Required if Sequence Item is present)	2C (Required if Sequence Item is present)
>Retrieve AE Title	(0008,0054)	2C (Required if Sequence Item is present)	2C (Required if Sequence Item is present)
>Referenced Image Sequence	(0008,1140)	2C (Required if Sequence Item is present)	2C (Required if Sequence Item is present)
>>Referenced SOP Class UID	(0008,1150)	1C (Required if Sequence Item is present)	1C (Required if Sequence Item is present)
>>Referenced SOP Instance UID	(0008,1155)	1C (Required if Sequence Item is present)	1C (Required if Sequence Item is present)

10.2.2 Operations**10.2.2.1 Action Information**

**TABLE 10.2-6
MODALITY PERFORMED PROCEDURE STEP - ACTION INFORMATION**

Request Type	Attribute	Tag	Requirement Type SCU
N-CREATE	Scheduled Step Attribute Sequence	(0040,0270)	1
	>Study Instance UID	(0020,000D)	1
	>Accession Number	(0008,0050)	2, supported
	>Requested Procedure ID	(0040,1001)	2, supported
	>Requested Procedure Description	(0032,1060)	2, supported
	>Scheduled Procedure Step ID	(0040,0009)	2, supported
	>Scheduled Procedure Step Description	(0040,0007)	2, supported
	Patient's Name	(0010,0010)	2, supported
	Patient ID	(0010,0020)	2, supported
	Patient's Birth Date	(0010,0032)	2, supported
	Patient's Sex	(0010,0040)	2, supported
	Performed Procedure Step ID	(0040,0253)	1
	Performed Station AE Title	(0040,0241)	1
	Performed Station Name	(0040,0242)	2, supported
	Performed Location	(0040,0243)	2, supported (Institution Name)
	Performed Procedure Step Start Date	(0040,0244)	1
	Performed Procedure Step Start Time	(0040,0245)	1

	Performed Procedure Step Status	(0040,0252)	1
	Performed Procedure Step Description	(0040,0254)	2, always empty
	Performed Procedure Type Description	(0040,0255)	2, always empty
	Procedure Code Sequence	(0008,1032)	2, always empty
	>Code Value	(0008,0100)	1C (Required if Sequence Item is present)
	>Coding Scheme Designator	(0008,0102)	1C (Required if Sequence Item is present)
	>Code Meaning	(0008,0104)	3
	Performed Procedure Step End Date	(0040,0250)	2, always empty
	Performed Procedure Step End Time	(0040,0251)	2, always empty
	Modality	(0008,0060)	1
	Study ID	(0020,0010)	2, supported
	Performed Series Sequence	(0040,0340)	2, always empty
	>Performing Physician's Name	(0008,1050)	2C (Required if Sequence Item is present)
	>Protocol Name	(0018,1030)	1C (Required if Sequence Item is present)
	>Operator's Name	(0008,1070)	2C (Required if Sequence Item is present)
	>Series Instance UID	(0020,000E)	1C (Required if Sequence Item is present)
	>Series Description	(0008,103E)	2C (Required if Sequence Item is present)
	>Retrieve AE Title	(0008,0054)	2C (Required if Sequence Item is present)
	>Referenced Image Sequence	(0008,1140)	2C (Required if Sequence Item is present)

	>>Referenced SOP Class UID	(0008,1150)	1C (Required if Sequence Item is present)
	>>Referenced SOP Instance UID	(0008,1155)	1C (Required if Sequence Item is present)
N-SET	Performed Procedure Step Status	(0040,0252)	3, supported
	Performed Procedure Step Description	(0040,0254)	3, not supported
	Performed Procedure Type Description	(0040,0255)	3, not supported
	Procedure Code Sequence	(0008,1032)	3, not supported
	>Code Value	(0008,0100)	1C (Required if Sequence Item is present)
	>Coding Scheme Designator	(0008,0102)	1C (Required if Sequence Item is present)
	>Code Meaning	(0008,0104)	3
	Performed Procedure Step End Date	(0040,0250)	3, not supported
	Performed Procedure Step End Time	(0040,0251)	3, not supported
	Performed Series Sequence	(0040,0340)	3, supported
	>Performing Physician's Name	(0008,1050)	2C (Required if Sequence Item is present)
	>Protocol Name	(0018,1030)	1C (Required if Sequence Item is present)
	>Operator's Name	(0008,1070)	2C (Required if Sequence Item is present)
	>Series Instance UID	(0020,000E)	1C (Required if Sequence Item is present)
	>Series Description	(0008,103E)	2C (Required if Sequence Item is present)
	>Retrieve AE Title	(0008,0054)	2C (Required if Sequence Item is present)

	>Referenced Image Sequence	(0008,1140)	2C (Required if Sequence Item is present)
	>>Referenced SOP Class UID	(0008,1150)	1C (Required if Sequence Item is present)
	>>Referenced SOP Instance UID	(0008,1155)	1C (Required if Sequence Item is present)

10.2.2.2 Service Class User Behavior

EchoPAC sends N-CREATE, N-SET including all acquired images' UIDs and an N-SET with the status of COMPLETED after a successful export of images. UIDs for imported DICOM images or Secondary Captures are not included in the Modality Performed Procedure Step messages.

10.2.2.3 Status Codes

No Service Class specific status values are defined for the NACTION Service. See PS 3.7 for general response status codes.

11. STORAGE COMMITMENT PUSH MODEL SOP CLASS DEFINITION

11.1 INTRODUCTION

This section of the DICOM Conformance Statement specifies the Storage Commitment Push Model SOP Class, the optional attributes and service elements supported, the valid range of values for mandatory and optional attributes, and the status code behavior.

11.2 STORAGE COMMITMENT PUSH MODEL SOP CLASS DEFINITION

11.2.1 IOD Description

11.2.1.1 STORAGE COMMITMENT MODULE

TABLE 11.2-1
STORAGE COMMITMENT MODULE

Attribute Name	Tag	Attribute Description
Transaction UID	(0008,1195)	Uniquely generated by the equipment
Retrieve AE Title	(0008,0054)	Not used
Storage Media File-Set ID	(0088,0130)	Not used
Storage Media File-Set UID	(0088,0140)	Not used
Referenced SOP Sequence	(0008,1199)	
>Referenced SOP Class UID	(0008,1150)	
>Referenced SOP Instance UID	(0008,1155)	
>Retrieve AE Title	(0008,0054)	
>Storage Media File-Set ID	(0088,0130)	
>Storage Media File-Set UID	(0088,0140)	
Referenced Study Component Sequence	(0008,1111)	Not used
>Referenced SOP Class UID	(0008,1150)	Not used
>Referenced SOP Instance UID	(0008,1155)	Not used
Failed SOP Sequence	(0008,1198)	
>Referenced SOP Class UID	(0008,1150)	
>Referenced SOP Instance UID	(0008,1155)	
>Failure Reason	(0008,1197)	

TABLE 11.2 -2
FAILURE REASON VALUES AND SEMANTICS

Failure Reason	Meaning	SCU Behavior	SCP Behavior
0110H	Processing failure	The request will be considered lost and the user must manually re-export the images.	N/A
0112H	No such object instance	The request will be considered lost and the user must manually re-export the images.	N/A
0213H	Resource limitation	The request will be considered lost and the user must manually re-export the images.	N/A
0122H	Referenced SOP Class not supported	The request will be considered lost and the user must manually re-export the images.	N/A
0119H	Class / Instance conflict	The request will be considered lost and the user must manually re-export the images.	N/A
0131H	Duplicate transaction UID	The request will be considered lost and the user must manually re-export the images.	N/A

11.2.2 DIMSE Service Group

DIMSE Service Element	Usage SCU/SCP
N-EVENT-REPORT	M/M
N-ACTION	M/M

11.2.3 Operations

11.2.3.1 Action Information

TABLE 11.2-3
STORAGE COMMITMENT REQUEST - ACTION INFORMATION

Action Type Name	Action Type ID	Attribute	Tag	Requirement Type SCU/SCP
Request Storage Commitment	1	Transaction UID	(0008,1195)	1/1
		Storage Media File-Set ID	(0088,0130)	Not used
		Storage Media File-Set UID	(0088,0140)	Not used
		Referenced SOP Sequence	(0008,1199)	1/1
		>Referenced SOP Class UID	(0008,1150)	1/1
		>Referenced SOP Instance UID	(0008,1155)	1/1
		>Storage Media File-Set ID	(0088,0130)	Not used
		>Storage Media File-Set UID	(0088,0140)	Not used
		Referenced Study Component Sequence	(0008,1111)	Not used
		>Referenced SOP Class UID	(0008,1150)	Not used
		>Referenced SOP Instance UID	(0008,1155)	Not used

11.2.3.2 Service Class User Behavior

EchoPAC sends the N-ACTION primitive (Storage Commitment Request) after successful export of image(s) if Storage Commitment is configured and EchoPAC is not in DICOM mode. Imported DICOM images or Secondary Captures are not included in the Storage Commitment operation.

EchoPAC may request storage commitment for the following generated SOP Class UIDs:

Ultrasound Multi-frame Image Storage	1.2.840.10008.5.1.4.1.1.3.1
Ultrasound Multi-frame Image Storage (Retired)	1.2.840.10008.5.1.4.1.1.3
Ultrasound Image Storage	1.2.840.10008.5.1.4.1.1.6.1
Ultrasound Image Storage (Retired)	1.2.840.10008.5.1.4.1.1.6

The Referenced Study Component Sequence Attribute is not supported.

The Transaction UID is valid a configurable number of days. If no answer is received, the request will be removed without warning the user.

The optional Storage Media File-Set ID & UID Attributes in the N-ACTION are not supported.

On receipt of an unsuccessful N-ACTION Response Status Code from the SCP, the request will be lost and the user must manually re-export the images.

11.2.3.3 Status Codes

No Service Class specific status values are defined for the NACTION Service. See PS 3.7 for general response status codes.

11.2.4 Notifications

11.2.4.1 Event Information

TABLE 11.2 -4
STORAGE COMMITMENT RESULT - EVENT INFORMATION

Event Type Name	Event Type ID	Attribute	Tag	Requirement Type SCU/SCP		
Storage Commitment Request Successful	1	Transaction UID	(0008,1195)	-/1		
		Retrieve AE Title	(0008,0054)	Not used		
		Storage Media File-Set ID	(0088,0130)	Not used		
		Storage Media File-Set UID	(0088,0140)	Not used		
		Referenced SOP Sequence	(0008,1199)	-/1		
		>Referenced SOP Class UID	(0008,1150)	-/1		
		>Referenced SOP Instance UID	(0008,1155)	-/1		
		>Retrieve AE Title	(0008,0054)	Not used		
		>Storage Media File-Set ID	(0088,0130)	Not used		
		>Storage Media File-Set UID	(0088,0140)	Not used		
		Storage Commitment Request Complete - Failures Exist	2	Transaction UID	(0008,1195)	-/1
				Retrieve AE Title	(0008,0054)	Not used
				Storage Media File-Set ID	(0088,0130)	Not used
Storage Media File-Set UID	(0088,0140)			Not used		
Referenced SOP Sequence	(0008,1199)			-/1C		
>Referenced SOP Class UID	(0008,1150)			-/1		
>Referenced SOP Instance UID	(0008,1155)			-/1		
>Retrieve AE Title	(0008,0054)			Not used		
>Storage Media File-Set ID	(0088,0130)			Not used		
>Storage Media File-Set UID	(0088,0140)			Not used		
Failed SOP Sequence	(0008,1198)			-/1		
>Referenced SOP Class UID	(0008,1150)			-/1		
>Referenced SOP Instance UID	(0008,1155)			-/1		
>Failure Reason	(0008,1197)	-/1				

11.2.4.2 Service Class User Behavior

If a successful answer is received, the request will be removed without warning the user.

If a non-successful answer is received, the request will be removed without warning the user after a configurable time period.

11.2.4.3 Status Codes

No Service Class specific status values are defined for the N-EVENT-REPORT Service. See PS 3.7 for general response status code.