



GE Medical Systems

Modality Installation Planning
Milwaukee,

Wisconsin

ULTRASOUND LOGIQ 700

THE EQUIPMENT ILLUSTRATED IN THIS PACKAGE REPRESENTS A TYPICAL SET OF PLANS TO SUGGEST LOCATIONS FOR GE MEDICAL SYSTEMS EQUIPMENT AND ASSOCIATED APPARATUS, ELECTRICAL DETAILS, AND ROOM ARRANGEMENTS. IT IS NOT TO BE USED FOR ACTUAL CONSTRUCTION PURPOSES AND THE COMPANY HEREBY DISCLAIMS RESPONSIBILITY FOR ANY DAMAGE RESULTING THEREFROM.

TYPICAL FINAL INSTALLATION DRAWINGS

PROJECT NO.:	tp0260
REVISION:	00
DATE:	1/4/99
DONE BY:	PM

GENERAL SPECIFICATIONS

- THE REQUIRED CEILING HEIGHT INDICATED ON THESE PLANS IS TO INSURE EQUIPMENT FUNCTION IS NOT INHIBITED. CONSULT WITH YOUR LOCAL GEMS INSTALLATION SPECIALIST REGARDING ACCEPTABILITY OF OTHER CEILING HEIGHTS. 8'-0" MINIMUM.
- CLEAR DOOR OPENINGS FOR MOVING EQUIPMENT INTO BUILDING MUST BE 32" W x 78" H MIN. OR LARGER, CONTINGENT ON AN 4'-0" CORRIDOR WIDTH.
- CHECK ALL DOOR OPENINGS AND ELEVATORS FROM DELIVERY LOCATION TO WHERE EQUIPMENT IS TO BE INSTALLED.
- **RADIATION PROTECTION IS NOT REQUIRED FOR AN ULTRASOUND EXAM ROOM.**
- THE DEVELOPMENT OF THE EQUIPMENT LAYOUT, ROOM DIMENSIONS, MECHANICAL AND ELECTRICAL SUGGESTIONS IS PREDICATED UPON THE BEST INFORMATION OBTAINABLE FROM THE SITE, COUPLED WITH THE CUSTOMER'S KNOWN DESIRES. ARCHITECTURAL OR ELECTRICAL CHANGES INCLUDING RELOCATION OF EQUIPMENT ILLUSTRATED ON THIS DRAWING IS ALLOWED ONLY WITH NOTIFICATION, IN WRITING, AND REVIEW BY GEMS SERVICE DEPARTMENT. EQUIPMENT OPERATION, SERVICEABILITY, AND RESTRICTING CABLE LENGTHS, ETC., MAKE THIS ESSENTIAL FOR A PROPER INSTALLATION. GEMS RESERVES THE RIGHT TO MAKE ON THE JOB CHANGES BECAUSE OF CUSTOMER REQUIREMENTS AND/OR OBSTACLES IN CONSTRUCTION, ETC..
- ALL WORK TO BE IN COMPLIANCE WITH NATIONAL AND LOCAL BUILDING SAFETY CODES.
- DIMENSIONS ARE TO FINISHED SURFACES OF ROOM

SITE ENVIRONMENT SPECIFICATIONS

- AMBIENT OPERATING TEMPERATURE: 59 TO 86 DEGREES (F), 15 TO 30 DEGREES (C). MAXIMUM ALLOWABLE TEMPERATURE CHANGE OF 15 DEGREES (F)/HOUR.
- HUMIDITY: 5 TO 85 PERCENT NON-CONDENSING, MAXIMUM ALLOWABLE CHANGE OF 10 PERCENT/HOUR.
- ALTITUDE: NOT TO EXCEED 10,000 FT. ABOVE SEA LEVEL.
- THE ENVIRONMENT FOR THE SENOGAPHE UNIT MUST BE CONTROLLED SO THE ABOVE RESTRICTIONS ARE NOT EXCEEDED.

MAGNETIC INTERFERENCE SPECIFICATIONS

- ULTRASOUND UNIT MUST BE LOCATED IN AMBIENT STATIC MAGNETIC FIELDS OF LESS THAN 1 GAUSS TO GUARANTEE SPECIFIED IMAGING PERFORMANCE.

GE EQUIPMENT LISTING

NOTE: LOCAL CONDITIONS MAY DICTATE THAT ITEMS IDENTIFIED IN THIS CATEGORY BE INSTALLED BY OTHERS.

EQUIPMENT CROSS REFERENCE CHART

P = PREAPPROVAL
 C = CALCULATIONS/
 SEISMIC STATUS PENDING APPROVAL
 S = SPECIFICATIONS ONLY

ITEM NO.	QUANTITY ORDERED	ITEM DESCRIPTION (* = EXISTING/REINSTALL)	WEIGHT	HEAT OUTPUT	DETAIL NO.	STRC PLAN	ELEC PLAN	
①	1	LOGIQ 700 ULTRASOUND UNIT	794 lbs	6502 btu		---		S

ANCILLARY ITEMS

CUSTOMER/CONTRACTOR SUPPLIED AND INSTALLED ITEMS

ITEM NO.	ITEM DESCRIPTION (* INDICATES EXISTING)
60	OPERATORS CHAIR
61	MINIMUM DOOR OPENING FOR EQUIPMENT DELIVERY IS 32 IN. W X 78 IN. H [813MM X 1981MM], CONTINGENT ON A 60 IN. [1524MM] CORRIDOR WIDTH
62	PATIENT BED

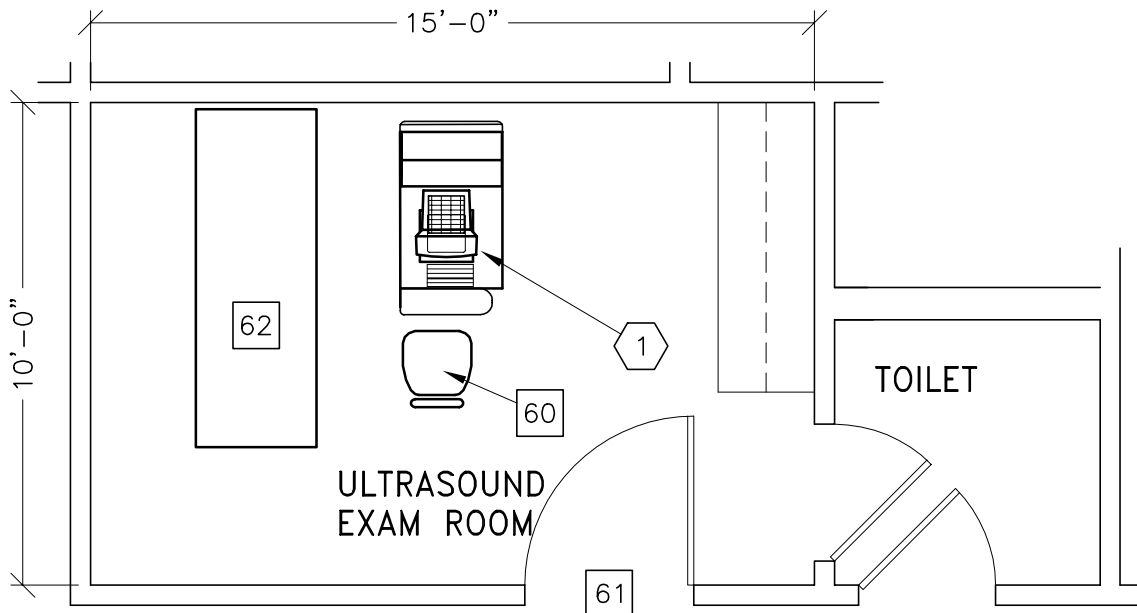

EQUIPMENT LAYOUT

SCALE: 1/4" = 1'-0"

LOGIQ 700 POWER SPECIFICATIONS REV. DATE: 11/16/98

VOLTAGE POWER TRANSIENTS MUST BE LESS THAN 25% OVER NOMINAL PEAK VOLTAGE FOR LESS THAN 1 ms FOR ANY TYPE OF TRANSIENT. THIS INCLUDES LINE FREQUENCY, SYNCHRONOUS, ASYNCHRONOUS, OR APERIODIC TRANSIENTS.

IF THE SITE'S POWER LINE VOLTAGE DOES NOT MEET THE REQUIREMENTS OUTLINED, IT IS SUGGESTED THAT A FERRO RESONANT UNINTERRUPTABLE POWER SUPPLY (UPS) BE PROVIDED. A TAP SWITCHING LINE CONDITIONER IS NOT RECOMMENDED AS IT CAN HAVE LARGE SWITCHING TRANSIENTS WHICH MAY EXCEED THE MAXIMUM LEVEL SPECIFIED FOR THE LOGIQ SYSTEM.

INRUSH CURRENT FOR THE 120 V, 20 A SITE, INRUSH CURRENT IS 50 TO 175 A FOR UP TO 4 ms. FOR OTHER SYSTEM POWER CONFIGURATIONS WITH THE V2 MACHINE, INRUSH WILL BE LESS THAN 70A.



CIRCUIT BREAKER IT IS RECOMMENDED THAT THE BRANCH CIRCUIT BREAKER FOR THE MACHINE BE READILY ACCESSIBLE. IT SHOULD HAVE AT LEAST 5 TIMES THE RATED CURRENT TOLERANCE.

POWER OUTLETS THE AC POWER OUTLET MUST BE WITHIN 8 FEET (2.5M) OF THE UNIT. OTHER OUTLETS ADEQUATE FOR THE EXTERNAL PERIPHERALS, MEDICAL AND TEST EQUIPMENT NEEDED TO SUPPORT THIS UNIT MUST ALSO BE PRESENT WITHIN 3.2 FEET (1M) OF THE UNIT. ELECTRICAL INSTALLATION MUST MEET ALL CURRENT LOCAL, STATE AND NATIONAL ELECTRICAL CODES.

POWER DEMAND

COMPONENT	MAX DEMAND KVA	CURRENT (AMP)		VOLTAGE (NOMINAL)	PHASE	REGULATION
		MOMEN-TARY	LONG TIME			
LOGIQ	3		20	120	1	10
	2.2		10	220	1	10

OUTLET KEY

-  120V, 1 ϕ , 20A, NEMA 5-20 HOSPITAL GRADE OUTLET
-  DEDICATED ANALOG PHONE LINE FOR INSITE CONNECTION
-  NETWORK OUTLET

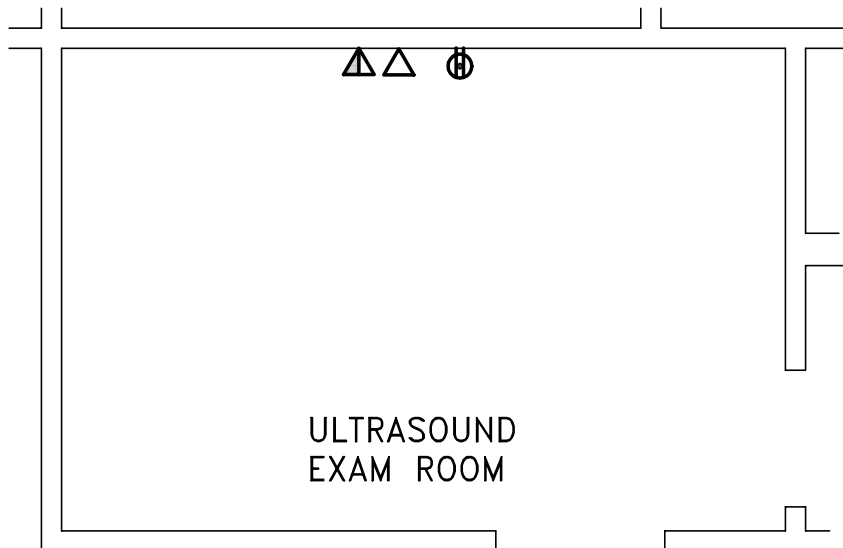

EQUIPMENT DETAIL

LOGIQ 700 DIGITAL ULTRASOUND SYSTEM

B7117

REV. DATE: 11/16/98

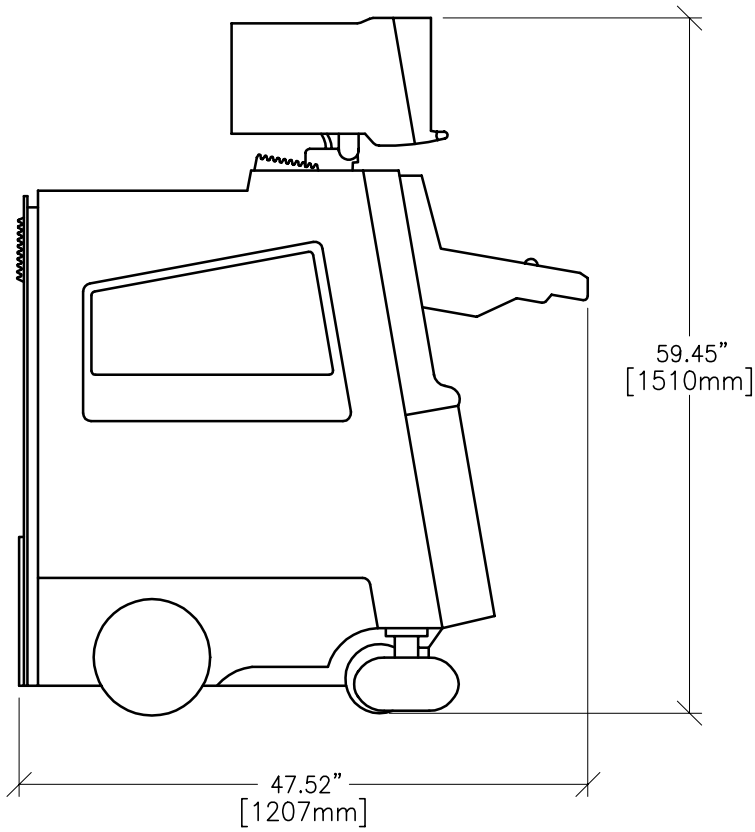

SIDE VIEW

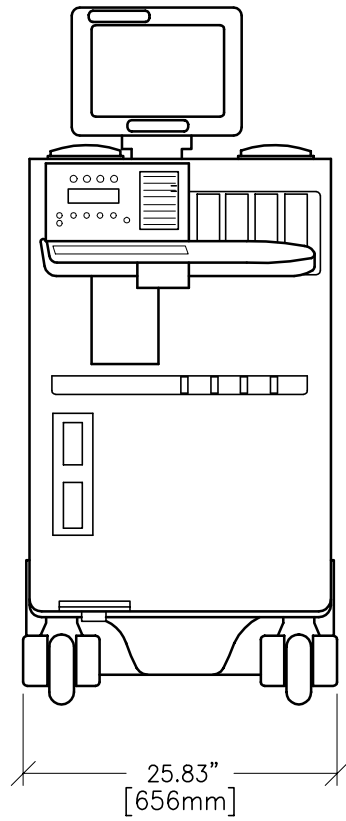

FRONT VIEW

DETAIL NOT TO SCALE