



***GE Medical Systems***

---

# **Technical Publications**

**Direction 2142505–100**

**Revision 6**

**Advantx DLX  
(ID/NET V3.0)**

**Dicom Conformance Statement**

**This document applies to DLX  
Release C19.XX**

**do not duplicate**

**Copyright © 2000 by General Electric Co.**

Blank page

## TABLE OF CONTENTS

CHAPTER	TITLE	PAGE
	REVISION HISTORY .....	v
	LIST OF EFFECTIVE PAGES .....	v
1	<b>INTRODUCTION TO THE INTEGRATED DICOM/NETWORK V3.0 (ID/NETV3.0) CONFORMANCE STATEMENT</b> <b>Direction: 2118780-100</b>	
2	<b>ADVANTX DLX CONFORMANCE STATEMENT FOR DICOM V3.0 (ID/NETV3.0)</b> <b>Direction: 2142506-100</b>	

Blank page

**WARNING**

- THIS SERVICE MANUAL IS AVAILABLE IN ENGLISH ONLY.
- IF A CUSTOMER'S SERVICE PROVIDER REQUIRES A LANGUAGE OTHER THAN ENGLISH, IT IS THE CUSTOMER'S RESPONSIBILITY TO PROVIDE TRANSLATION SERVICES.
- DO NOT ATTEMPT TO SERVICE THE EQUIPMENT UNLESS THIS SERVICE MANUAL HAS BEEN CONSULTED AND IS UNDERSTOOD.
- FAILURE TO HEED THIS WARNING MAY RESULT IN INJURY TO THE SERVICE PROVIDER, OPERATOR OR PATIENT FROM ELECTRIC SHOCK, MECHANICAL OR OTHER HAZARDS.

**AVERTISSEMENT**

- CE MANUEL DE MAINTENANCE N'EST DISPONIBLE QU'EN ANGLAIS.
- SI LE TECHNICIEN DU CLIENT A BESOIN DE CE MANUEL DANS UNE AUTRE LANGUE QUE L'ANGLAIS, C'EST AU CLIENT QU'IL INCOMBE DE LE FAIRE TRADUIRE.
- NE PAS TENTER D'INTERVENTION SUR LES ÉQUIPEMENTS TANT QUE LE MANUEL SERVICE N'A PAS ÉTÉ CONSULTÉ ET COMPRIS.
- LE NON-RESPECT DE CET AVERTISSEMENT PEUT ENTRAÎNER CHEZ LE TECHNICIEN, L'OPÉRATEUR OU LE PATIENT DES BLESSURES DUES À DES DANGERS ÉLECTRIQUES, MÉCANIQUES OU AUTRES.

**WARNUNG**

- DIESES KUNDENDIENST-HANDBUCH EXISTIERT NUR IN ENGLISCHER SPRACHE.
- FALLS EIN FREMDER KUNDENDIENST EINE ANDERE SPRACHE BENÖTIGT, IST ES AUFGABE DES KUNDEN FÜR EINE ENTSPRECHENDE ÜBERSETZUNG ZU SORGEN.
- VERSUCHEN SIE NICHT, DAS GERÄT ZU REPARIEREN, BEVOR DIESES KUNDENDIENST-HANDBUCH NICHT ZU RATE GEZOGEN UND VERSTANDEN WURDE.
- WIRD DIESE WARNUNG NICHT BEACHTET, SO KANN ES ZU VERLETZUNGEN DES KUNDENDIENSTTECHNIKERS, DES BEDIENERS ODER DES PATIENTEN DURCH ELEKTRISCHE SCHLÄGE, MECHANISCHE ODER SONSTIGE GEFAHREN KOMMEN.

**AVISO**

- ESTE MANUAL DE SERVICIO SÓLO EXISTE EN INGLÉS.
- SI ALGÚN PROVEEDOR DE SERVICIOS AJENO A GEMS SOLICITA UN IDIOMA QUE NO SEA EL INGLÉS, ES RESPONSABILIDAD DEL CLIENTE OFRECER UN SERVICIO DE TRADUCCIÓN.
- NO SE DEBERÁ DAR SERVICIO TÉCNICO AL EQUIPO, SIN HABER CONSULTADO Y COMPRENDIDO ESTE MANUAL DE SERVICIO.
- LA NO OBSERVANCIA DEL PRESENTE AVISO PUEDE DAR LUGAR A QUE EL PROVEEDOR DE SERVICIOS, EL OPERADOR O EL PACIENTE SUFRAN LESIONES PROVOCADAS POR CAUSAS ELÉCTRICAS, MECÁNICAS O DE OTRA NATURALEZA.

**ATENÇÃO**

- ESTE MANUAL DE ASSISTÊNCIA TÉCNICA SÓ SE ENCONTRA DISPONÍVEL EM INGLÊS.
- SE QUALQUER OUTRO SERVIÇO DE ASSISTÊNCIA TÉCNICA, QUE NÃO A GEMS, SOLICITAR ESTES MANUAIS NOUTRO IDIOMA, É DA RESPONSABILIDADE DO CLIENTE FORNECER OS SERVIÇOS DE TRADUÇÃO.
- NÃO TENHA TENTADO REPARAR O EQUIPAMENTO SEM TER CONSULTADO E COMPREENDIDO ESTE MANUAL DE ASSISTÊNCIA TÉCNICA.
- O NÃO CUMPRIMENTO DESTA AVISO PODE POR EM PERIGO A SEGURANÇA DO TÉCNICO, OPERADOR OU PACIENTE DEVIDO A CHOQUES ELÉTRICOS, MECÂNICOS OU OUTROS.

**AVVERTENZA**

- IL PRESENTE MANUALE DI MANUTENZIONE È DISPONIBILE SOLTANTO IN INGLESE.
- SE UN ADDETTO ALLA MANUTENZIONE ESTERNO ALLA GEMS RICHIEDE IL MANUALE IN UNA LINGUA DIVERSA, IL CLIENTE È TENUTO A PROVVEDERE DIRETTAMENTE ALLA TRADUZIONE.
- SI PROCEDA ALLA MANUTENZIONE DELL'APPARECCHIATURA SOLO DOPO AVER CONSULTATO IL PRESENTE MANUALE ED AVERNE COMPRESO IL CONTENUTO.
- NON TENERE CONTO DELLA PRESENTE AVVERTENZA POTREBBE FAR COMPIERE OPERAZIONI DA CUI DERIVINO LESIONI ALL'ADDETTO ALLA MANUTENZIONE, ALL'UTILIZZATORE ED AL PAZIENTE PER FOLGORAZIONE ELETTRICA, PER URTI MECCANICI OD ALTRI RISCHI.

**警告**

- ・このサービスマニュアルには英語版しかありません。
- ・GEMS以外でサービスを担当される業者が英語以外の言語を要求される場合、翻訳作業はその業者の責任で行うものとさせていただきます。
- ・このサービスマニュアルを熟読し理解せずに、装置のサービスを行わないで下さい。
- ・この警告に従わない場合、サービスを担当される方、操作員あるいは患者さんが、感電や機械的又はその他の危険により負傷する可能性があります。

**注意:**

- 本维修手册仅存有英文本。
- 非 GEMS 公司的维修员要求非英文本的维修手册时，客户需自行负责翻译。
- 未详细阅读和完全了解本手册之前，不得进行维修。
- 忽略本注意事项会对维修员，操作员或病人造成触电，机械伤害或其他伤害。

**REVISION HISTORY**

<b>REV</b>	<b>DATE</b>	<b>REASON FOR CHANGE</b>
0	Nov. 28, 1995	Initial release to Direction Stock.
1	April, 1997	PART 2 Direction: 2142506-100 Updated
2	November, 1997	PART 2 Direction: 2142506-100 Updated for coherence with Software and new information on Worklist
3	June 1998	PART 2 Direction: 2142506-100 Updated: 3D function – Errors Corrections in texts, details codes for Adx_reverse_Sweep field, and Worklist information updated
4	April 1999	Title page updated with “This document applies to DLX Release C16.12 and C17.12”
5	July 1999	Title page updated with “This document applies to DLX Release C18.XX”
6	February 2000	Title page updated with “This document applies to DLX Release C19.XX”. Real-world Activity “Verification” added.

**LIST OF EFFECTIVE PAGES**

<b>PAGE NUMBER</b>	<b>REVISION NUMBER</b>	<b>PAGE NUMBER</b>	<b>REVISION NUMBER</b>	<b>PAGE NUMBER</b>	<b>REVISION NUMBER</b>
Title page	6				
i thru vi	6				

Blank page





***GE Medical Systems***

---

# **Technical Publications**

**Direction 2118780**

**Revision 0**

## **Introduction to the Integrated – Dicom/Network V3.0 (ID/NET V3.0) Conformance Statement**

**do not duplicate**

**Copyright © 1995 by General Electric Co.**

Blank page

**REVISION HISTORY**

<b>REV</b>	<b>DATE</b>	<b>REASON FOR CHANGE</b>
0	August 31, 1994	Initial release to Direction Stock.

**LIST OF EFFECTIVE PAGES**

<b>PAGE NUMBER</b>	<b>REVISION NUMBER</b>	<b>PAGE NUMBER</b>	<b>REVISION NUMBER</b>	<b>PAGE NUMBER</b>	<b>REVISION NUMBER</b>
Title Page	0				
Revision History I thru II	0				
Table of Contents i thru ii	0				
Introduction 1-1 thru 1-8	0				
Network Architecture Concepts 2-1 thru 2-8	0				
Application Layer Concepts Used In DICOM v3.0 and ID/Net 3-1 thru 3-8	0				
References 4-1 thru 4-6	0				

**THIS PAGE LEFT INTENTIONALLY BLANK**

**TABLE OF CONTENTS**

**SECTION 1 – INTRODUCTION ..... 1-1**

- 1-1 OVERVIEW ..... 1-1
- 1-2 INTENDED AUDIENCE FOR THIS DOCUMENT ..... 1-2
- 1-3 CONNECTIVITY FOR INCREASED EFFICIENCY ..... 1-2
- 1-4 THE NEED FOR A STANDARD ..... 1-2
- 1-5 ID/NET – AN OPEN, INTEGRATED INTERFACE ..... 1-3
  - 1-5-1 ID/Net – An Integrated Network ..... 1-3
  - 1-5-2 ID/Net – An Open Network ..... 1-3
  - 1-5-3 ID/Net – Support by GE Products and ID/Net DICOM  
Conformance Statements ..... 1-4
  - 1-5-4 ID/Net v3.0 Compatibility with ID/Net v2.0 ..... 1-5
- 1-6 IMPORTANT REMARKS ..... 1-6
- 1-7 OVERALL ID/NET DOCUMENTATION STRUCTURE .. 1-6
  - 1-7-1 ID/Net v3.0 Documentation ..... 1-8
  - 1-7-2 ID/Net v2.0 Documentation ..... 1-9

**SECTION 2 – NETWORK ARCHITECTURE CONCEPTS ..... 2-1**

- 2-1 OVERVIEW ..... 2-1
- 2-2 BASIC NETWORK LEVELS AND PROTOCOLS ..... 2-1
  - 2-2-1 Network Architecture and the Post Office Analogy ..... 2-2
  - 2-2-2 DICOM and the OSI Reference Model ..... 2-8

**SECTION 3 – APPLICATION LAYER CONCEPTS USED  
IN DICOM V3.0 AND ID/NET ..... 3-1**

- 3-1 OVERVIEW ..... 3-1
- 3-2 CONFORMANCE STATEMENTS ..... 3-1
- 3-3 DICOM V3.0 APPLICATION LAYER CONCEPTS ..... 3-2
  - 3-3-1 Information Object Definition ..... 3-3
  - 3-3-2 DICOM Message Service Element (DIMSE) Services ..... 3-3
  - 3-3-3 Service Object Pair (SOP) Class ..... 3-3
  - 3-3-4 Service Class ..... 3-4
  - 3-3-5 Association Negotiation ..... 3-4
  - 3-3-6 Example of AE Concepts ..... 3-5
- 3-4 UNIQUE IDENTIFIERS (UIDS) ..... 3-8
- 3-5 RELATIONSHIP OF CONCEPTS TO THE PARTS OF  
THE DICOM V3.0 STANDARDS ..... 3-9

**SECTION 4 – REFERENCES ..... 4-1**

- 4-1 NORMATIVE REFERENCES ..... 4-1
- 4-2 RELATED PUBLICATIONS OF INTEREST ..... 4-1
- 4-3 DICOM SOFTWARE COMMONLY AVAILABLE ..... 4-1
- 4-4 DEFINITIONS ..... 4-2
- 4-5 SYMBOLS AND ABBREVIATIONS ..... 4-5

**THIS PAGE LEFT INTENTIONALLY BLANK**

## SECTION 1 – INTRODUCTION

### 1–1 OVERVIEW

This document is the *Introduction to the Integrated DICOM/Network v3.0 (ID/Net v3.0) Conformance Statement*. It is applicable to all GE Medical Systems (GE) products which support the ID/Net v3.0 network. More specifically, this document is an introduction to the Conformance Statements related to GE ID/Net products.

**Section 1** provides general information about the GE strategy for Open Connectivity. It includes a brief description of the relationships of GE ID/Net v3.0 and the DICOM V3.0 standards and also includes important remarks which users of ID/Net should address carefully when connecting imaging systems.

**Section 2** is an overview of network architecture concepts, including the ISO seven layer model and the DICOM Applications Layer model.

**Section 3** describes the basic technical concepts and terminology which are used in the DICOM standard and the ID/Net environment.

**Section 4** provides some basic reference material (references, definitions, acronyms) for DICOM and ID/Net which is common to all GE DICOM Conformance Statements.

### 1–2 INTENDED AUDIENCE FOR THIS DOCUMENT

This document is intended for a broad audience in areas of medical imaging, software design, network planning, and/or systems integration. The reader must have a basic understanding of networking. The purpose of this document is to familiarize the reader with some of the ID/Net and DICOM v3.0 terminology and concepts.

If, however, the reader intends to work at the software implementation and/or systems integration levels, this Introduction will be helpful, but insufficient. In this case the reader must also read the DICOM v3.0 standard and the specific product Conformance Statements.

### 1–3 CONNECTIVITY FOR INCREASED EFFICIENCY

Connectivity is desirable for a number of reasons since it may provide clinical benefits and may increase the following departmental efficiencies:

- Rapid availability of images to diagnosticians and clinicians.
- Ease of exchange of images between locations (remotely or locally).
- Ease of image access for filming, reading, archiving (off-loading the tasks from scanners), or advanced analysis (3D, DentaScan).
- Integration of image acquisition and diagnostic information into the hospital information system, a necessary step toward patient record consolidation.

The benefits of shared digital information may include simultaneous access of information by multiple users, post processing of image data, reduction in film loss, reduction in film storage space, etc., which may result in increased productivity, efficiency, cost-effectiveness, and improved patient care. To pursue these potential benefits the concept of “Networked systems” must be incorporated. Fully networked systems are capable of **interoperating** to communicate image and related information. Simply being connected to a network does not mean that two devices can interoperate, that is, send, receive, display, analyze, or archive data, etc. ID/Net provides the interoperability foundation for networked devices, thus allowing customers to begin to choose equipment optimized for a particular application.

## 1-4 THE NEED FOR A STANDARD

True connectivity requires the definition and implementation of a common network communications standard among manufacturers, one that addresses a wide variety of imaging components – image acquisition equipment, display workstations, archiving systems, hard copy devices and information management systems, for example.

DICOM has emerged as the medical information networking standard, currently defining CT, MR, Nuclear Medicine, Ultrasound and Computed Radiography images, as well as Laser Camera and HIS/RIS interfaces. Also, the definition of X-Ray Angiography and Media Interchange is well underway. The development of DICOM has been the result of joint effort between NEMA (Medical Imaging Vendors) and the ACR (American College of Radiology). Other medical specialties have also contributed to this effort, in particular the ACC (American College of Cardiology).

DICOM is also a global standard. In particular, CEN in Europe is actively involved in the definition of DICOM standards and has decided to use DICOM as the basis for a European Standard. An active liaison also exists with the JIRA and IS&C committees in Japan. GE has been a major contributor to the development of this standard, and implementation of these DICOM concepts is realized in the GE ID/Net v3.0.

## 1-5 ID/NET – AN OPEN, INTEGRATED INTERFACE

The GE Integrated DICOM/Network v3.0 allows users to connect among GE DICOM imaging systems, as well as to other manufacturers' DICOM-based products. GE ID/Net v3.0 is a DICOM-based implementation which provides a common, open networking approach for medical imaging equipment. ID/Net is the **interoperability foundation** for a wide range of GE products and for interfacing with third party devices.

ID/Net provides the flexibility to configure, in many cases, network solutions that meet GE customers' diverse communication requirements. ID/Net also inherently provides for the option of purchasing standard network devices, such as cabling, transceivers, modems, routers, bridges, etc., to meet most network needs.

Because ID/Net is based upon networking standards, the size and configuration of health care site networks are flexible. The networking standards allow different technologies to be employed (e.g., wide area networks, local area networks, etc.).

With GE and ID/Net, you have the ability to begin accessing the benefits of connectivity today – and a solid link to the future.

### 1-5-1 ID/Net – An Integrated Network

ID/Net is *integrated*. DICOM standards are an integral part of product design, so investment in costly and complex gateways often needed to network between dissimilar proprietary networks is not likely (some older equipment may be an exception.)

### 1-5-2 ID/Net – An Open Network

ID/Net is *open*. It enables connectivity to other manufacturers' DICOM-compatible equipment. GE ID/Net interfaces are documented in DICOM Conformance Statements. If your current systems have not been built to DICOM standards, third party connections may be used to convert proprietary image format into DICOM standards.



### 1–5–3 ID/Net – Support by GE Products and ID/Net DICOM Conformance Statements

A number of GE systems are already demonstrating the effectiveness of ID/Net v2.0 and/or ID/Net v3.0 connectivity. Among them are our CT 9800, HiLight and HiSpeed Advantage systems, as well as MR Signa 5.X systems, Advantage Independent Consoles, and Advantage Windows workstations. As the DICOM standard evolves, additional modalities and connections are expected to be implemented.

For more specific information regarding current product capabilities and availability, please contact your GE Sales representative.

For the purposes of backward compatibility, the CT Advantage, MR Signa 5.x Advantage, and CT9800 ID/Link II continue to support ID/Net v2.0. This continuum in network connectivity is presented in section 1–5–4.

Any GE equipment which supports ID/Net will have a “DICOM Conformance Statement” available to the public. The Conformance Statement is an implementation profile which lists the DICOM functions (e.g., send a CT image, send an MR image, query for images, etc.) which have been implemented by a particular piece of equipment.

The DICOM standard, and thus ID/Net, is structured such that each device can implement the appropriate functions of the standard for its intended application. In order for two devices to interoperate, both devices must have a complementary set of functions implemented. As part of the standard, two devices negotiate before they begin to communicate to verify that the common function(s) does exist. However, before attempting to interoperate, the existence of a set of common functions should be determined by reviewing the Conformance Statement of each device. For example, a product could implement the “image send” function, but not the “image receive” function.

The exact technical specification of how ID/Net v3.0 implementations conform to DICOM v3.0 is given in each GE product ID/Net DICOM Conformance Statement. It is the intent of this document (“Introduction to the ID/Net v3.0 Conformance Statement”) to provide introductory information which is common and applicable to all ID/Net DICOM Conformance Statements.

The Conformance Statements may be ordered by specifying the Direction number, as defined in the “Overall ID/Net Documentation Structure”, section 1–7.

### 1–5–4 ID/Net v3.0 Compatibility with ID/Net v2.0

ID/Net v2.0 products were released before the DICOM Standard was completed. ID/Net v2.0 is a network protocol based on the DICOM Part 8 network communications specification, but with GE specific Information Object Definitions (IOD’s). The GE IOD’s are publicly available as the “ID/Net v2.0 Implementation Profiles”, Direction 46–269546G2, and are based on the April 1993 draft version of DICOM v3.0.

ID/Net v3.0 is fully compliant with the final version of DICOM v3.0, but also backward compatible with ID/Net v2.0 as shown in Illustration 1–1.

ILLUSTRATION 1–1

ID/NET V2.0 – ID/NET V3.0 RELATIONSHIP

### 1–6 IMPORTANT REMARKS

The use of these Conformance Statements, in conjunction with the DICOM v3.0 Standards, is intended to facilitate communication with GE imaging equipment. However, **by itself, it is not sufficient to ensure that inter-operation will be successful.** The user (or user’s agent) needs to proceed with caution and address at least four issues:

ID/NET V3.0

ID/NET V3.0										
ID/NET V2.0										
INFORMATION OBJECT DEFINITIONS:		CT	MR	DISPLAY	CT	MR	SECONDARY CAPTURE	OVERLAY	STUDY-BASED INFORMATION MODEL	
		GE	GE	GE	DICOM	DICOM	DICOM	DICOM		
SERVICE CLASSES:	VERIFICATION	STORAGE SERVICE CLASS							QUERY	RETRIEVE
DIMSE COMMANDS:	C-ECHO	C-STORE							C-FIND	C-MOVE
ASSOCIATION NEGOTIATION & DIMSE SERVICE										
DICOM/UL (DICOM PART 8)										
TCP/IP										
ETHERNET										

- Integration** – The integration of any device into an overall system of interconnected devices goes beyond the scope of standards (DICOM v3.0), and of this introduction and associated Conformance Statements when interoperability with non-GE equipment is desired. The responsibility to analyze the applications requirements and to design a solution that integrates GE imaging equipment with non-GE systems is the **user’s** responsibility and should not be underestimated. The **user** is strongly advised to ensure that such an integration analysis is correctly performed.
- Validation** – Testing the complete range of possible interactions between any GE device and non-GE devices, before the connection is declared operational, should not be overlooked. Therefore, the **user** should ensure that any non-GE provider accepts full responsibility for all validation required for their connection with GE devices. This includes the accuracy of the image data once it has crossed the interface between the GE imaging equipment and the non-GE device and the stability of the image data for the intended applications. Such a validation is required before any clinical use (diagnosis and/or treatment) is performed. It applies when images acquired on GE imaging equipment are processed/displayed on a non-GE device, as well as when images acquired on non-GE equipment is processed/displayed on a GE console or workstation.

- **Future Evolution** – GE understands that the DICOM Standard will evolve to meet the user’s growing requirements. GE is actively involved in the development of the DICOM v3.0 Standard. DICOM v3.0 will incorporate new features and technologies and GE may follow the evolution of the Standard. ID/Net v3.0 is based on DICOM v3.0 as specified in each ID/Net DICOM Conformance Statement. Evolution of the Standard may require changes to devices which have implemented DICOM v3.0. **In addition, GE reserves the right to discontinue or make changes to the support of communications features (on its products) reflected on by these ID/Net DICOM Conformance Statements.** The user should ensure that any non-GE provider, which connects with GE devices, also plans for the future evolution of the DICOM Standard. Failure to do so will likely result in the loss of function and/or connectivity as the DICOM Standard changes and GE Products are enhanced to support these changes.
- **Interaction** – It is the sole responsibility of the **non-GE provider** to ensure that communication with the interfaced equipment does not cause degradation of GE imaging equipment performance and/or function.

## 1–7 OVERALL ID/NET DOCUMENTATION STRUCTURE

The Documentation Structure presented in Illustration 1–1 (next page) shows the overall organization of the ID/Net documentation.

### ILLUSTRATION 1–2 DOCUMENTATION STRUCTURE

#### 1–7–1 ID/Net v3.0 Documentation

This document focuses upon the ID/Net DICOM v3.0 Conformance Statements and provides references to the ID/Net v2.0 Implementation Profiles. This document is the introductory level document:

*Introduction to the Integrated DICOM/Network v3.0  
(ID/Net v3.0) Conformance Statement  
Direction: 2118780*

This Introduction is applicable to all ID/Net v3.0 GE products. It is intended to familiarize the reader with ID/Net v3.0 and DICOM v3.0 terminology and general concepts. This document should be read prior to reading the product specific ID/Net DICOM Conformance Statements.

For the convenience of software developers, this Introduction and all of the currently published ID/Net DICOM Conformance Statements may be ordered under a single reference:

*ID/Net v3.0 Conformance Statements  
Direction: 2117016*

**ID/NET V3.0**

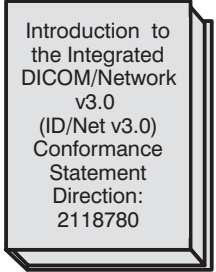

APPLICATION ENTITY SPECIFICATION  
(services classes, Information objects, message exchange, etc.)

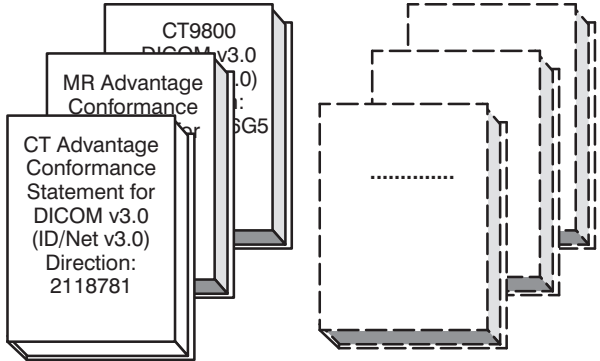

**PRODUCT IMPLEMENTATION:**

DICOM STANDARD

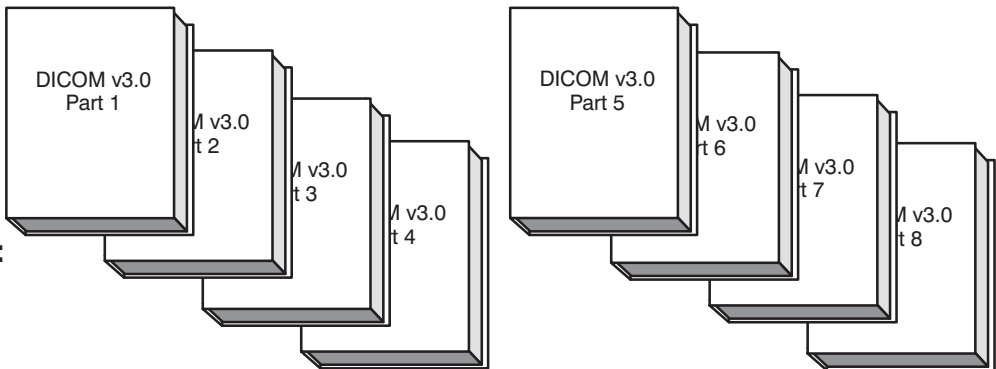

**STANDARD SPECIFICATION:**

**1-7-2 ID/Net v2.0 Documentation**

ID/Net v2.0 documentation followed a similar structure. In cases where installed equipment not yet upgraded to ID/Net v3.0 needs to be networked, the ID/Net v2.0 documentation (Implementation Profiles) include complete conformance statements. The following documents may be ordered:

*CT Advantage  
Implementation Profile for ACR-NEMA v2.0  
with DICOM v3.0 Extensions (ID/Net v2.0)  
Direction: 46-269546G3*

*MR Advantage  
Implementation Profile for ACR-NEMA v2.0  
with DICOM v3.0 Extensions (ID/Net v2.0)  
Direction: 46-269546G4*

*CT 9800  
Implementation Profile for ACR-NEMA v2.0  
with DICOM v3.0 Extensions (ID/Net v2.0)  
Direction: 46-269546G5*

For the sake of convenience, the ID/Net v2.0 documentation can be ordered under a single direction number:

*ID/Net v2.0 Implementation Profiles  
Direction 46-269546G2*

**THIS PAGE LEFT INTENTIONALLY BLANK**

## SECTION 2 – NETWORK ARCHITECTURE CONCEPTS

### 2–1 OVERVIEW

The second part of this document describes some of the Network Architecture concepts and models which are used in ID/Net v3.0 and DICOM v3.0. ID/Net v3.0 is fully based upon DICOM v3.0.

### 2–2 BASIC NETWORK LEVELS AND PROTOCOLS

A successful network architecture must be layered to facilitate integration of evolving technologies. The Open Systems Interconnection (OSI) Reference Model defined by the International Standards Organization is the accepted seven layer model for the design of modular network architectures.

The purpose of this Section is to provide a brief explanation of the OSI networking architecture. Section 2–2–1 provides some analogies to introduce these concepts. Section 2–2–2 illustrates how DICOM is based on the OSI reference model.

#### 2–2–1 Network Architecture and the Post Office Analogy

The fundamental choices made by the DICOM v3.0 Standard can be understood by comparing a digital medical image network to a postal system. A postal system is complex, employing computers to track and route mail, and trucks, trains, and airplanes to move mail. But for the end user, the complexity of the system is transparent.

When it comes to the content of the envelope, the two people who want to communicate need a common language for writing the letter. If they do not speak the same language but both know a third language, the third language would be the common language, the language of communication. For example, if a French person and a Japanese person both spoke English and they wanted to write to each other, they would go through this process (refer to Illustration 2–1 as you read the steps below it):

#### ILLUSTRATION 2–1 GETTING THE MESSAGE ACROSS

- 1.. The letter is composed in the writer's native language, for example, French.
- 2.. The letter is translated into English.
- 3.. The letter is inserted into an envelope, and the envelope is addressed to meet the postal system's requirements.
- 4.. The letter is put into a mail box, picked up by the writer's post office and sent across town or around the world.
- 5.. The letter is received by the reader's post office.
- 6.. The address on the envelope is read, and the letter is delivered to that address.
- 7.. The letter is opened and read in English.
- 8.. The English is translated into the reader's native language, for example, Japanese.

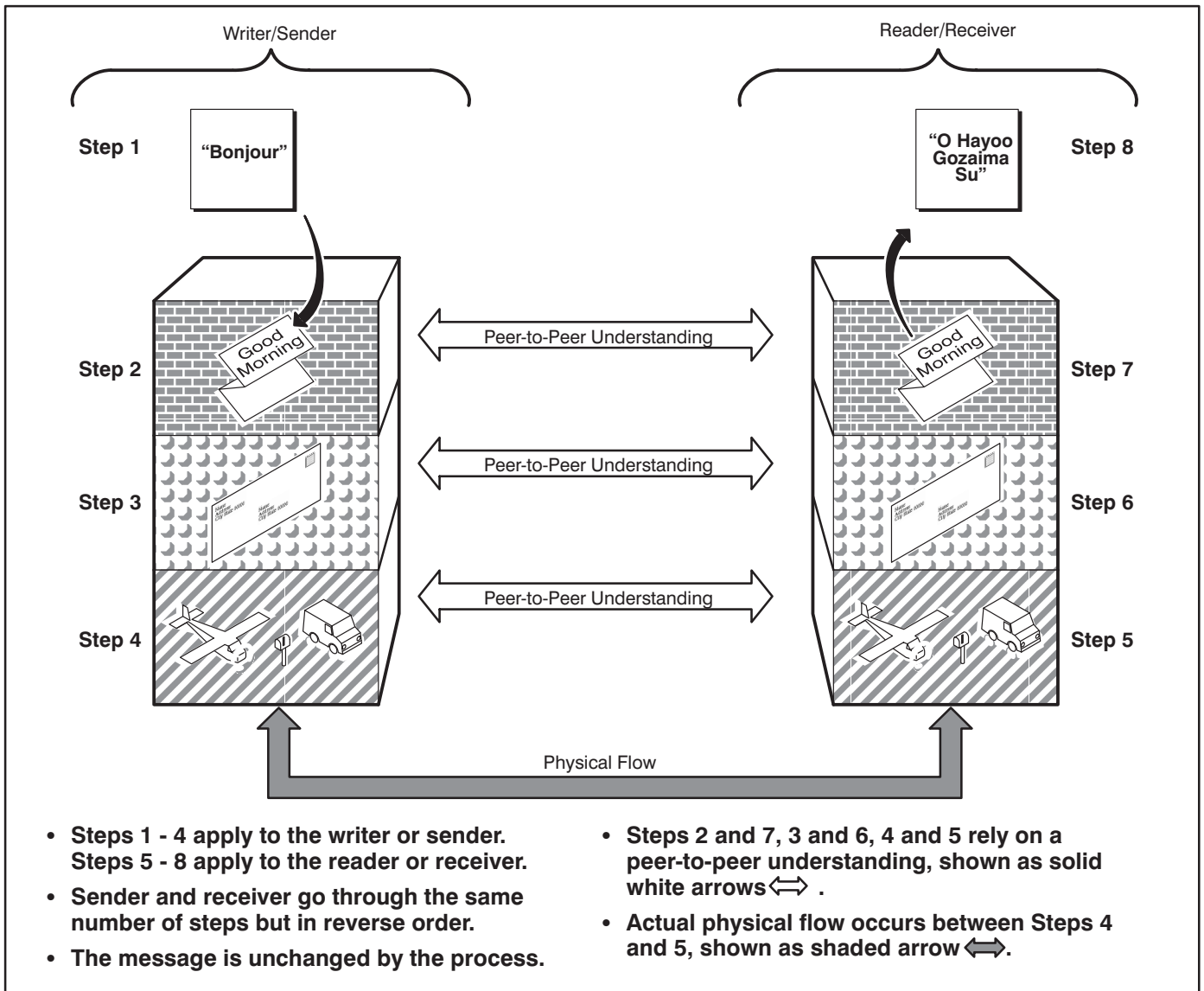

After packaging and addressing a letter and putting it into a mailbox, the postal system takes over and performs Steps 4 and 5. The letter could travel by truck, train or plane. The method of transportation does not matter as long as the letter is reliably delivered to its destination. Refer to Illustration 2-2 as you read the following:

- The devices on a digital medical network are similar to the businesses on a postal system. Just as each business is different, the devices can be different. They include workstations, image acquisition devices, information systems, image storage and distribution control devices, gateways, hard copy printers and other peripherals.
- The imaging and text data being transferred across a digital medical network varies, just as the contents of letters being carried by the postal system varies. The postal system does not care about the contents of the letters it delivers, nor does it alter the contents. In a similar manner, digital medical networks should transfer image and text data without altering the information.



- The postal system delivers both small envelopes and large packages. In the same manner, a digital medical network should reliably transfer a few bytes to mega-bytes of data.
- The postal system employs different methods of transportation to move the mail in an efficient and cost effective manner, including people, trucks, trains and airplanes. In the same way, digital medical networks should integrate different transmission technologies to get the job done:
  - Within the hospital, digital medical networks may support different types of Local Area Networks (LANs). For example, Ethernet, Fiber Distributed Data Interface (FDDI), Digital Links, Dial-up circuits, etc.
  - When communicating outside a hospital, a digital medical network should integrate Wide Area Networks (WANs) links. These links are in general provided by regional or national telecommunication carriers who use a combination of terrestrial, microwave and satellite technologies. A wide range of service and speeds are available ranging from kilobit per second phone lines to megabit per second leased lines and switched high speed services.

ILLUSTRATION 2-2  
 POSTAL SYSTEM COMPARED TO A DIGITAL MEDICAL NETWORK

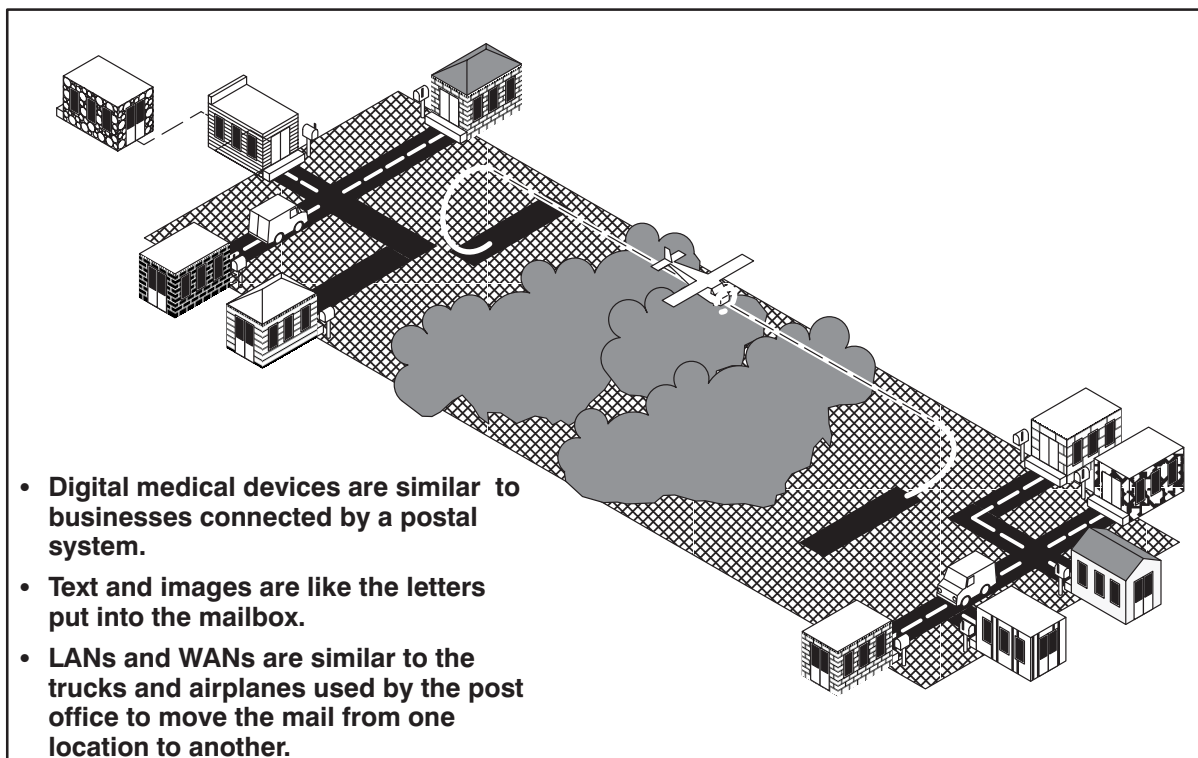

When digital medical devices need to “get the message across”, they communicate using the same steps as the businesses of the postal system. The sending and receiving digital medical devices should match at all levels of networking to guarantee efficient and reliable delivery of data. The three layers of networking and the application they support are defined immediately following Illustration 2–3.

ILLUSTRATION 2–3  
PARALLEL STRUCTURE OF NETWORKED DEVICES

- The application **Transactions and Database** are like the contents of a letter written in the native language. They are specific to each device, just as the usage of the contents of a letter is specific to each reader and writer. The DICOM v3.0 Standard only addresses the network communications functions and data necessary to support the applications. It does not specify the internal design of the device.
- The **Application Message Exchange** layer is similar to the translated letter. Using DICOM v3.0, this layer allows non-compatible platforms and applications to communicate by defining common protocols and formats which support such features as image transfer, database queries and retrieval of images/text related information.
- The **Logical Networking** layer is similar to the letter’s packaging and labeling. This layer defines how the message will be managed by the network and guarantees reliable delivery within a hospital and remote hospitals. The Logical Networking layer shields the Application Message Exchange layer from physical network technologies.
- The **Physical Networking** layer is similar to the trucks, trains and airplanes which transport the letter. It is the physical medium (i.e. cabling) and its access methods (access hardware and intermediate switches) such as Ethernet, FDDI, etc., which exchanges the bits of data. The Physical Networking layer should support a choice of options in order to address, in a cost effective manner, the various performance requirements of the Logical Networking layer.

The Logical and Physical Networking layers must work together to support the Application Message Exchange layer. To guarantee interoperability between devices, one approach must be specified for each layer. The selection of these choices establishes a network architecture.

Networking support is an integral part of any digital medical device. The Physical Network which externally links the device is a small component of what is required for devices to actually interoperate. The Logical Networking and Application Message Exchange functions which are integrated into the medical devices play a role transparent to the user, but fundamental to information exchange.

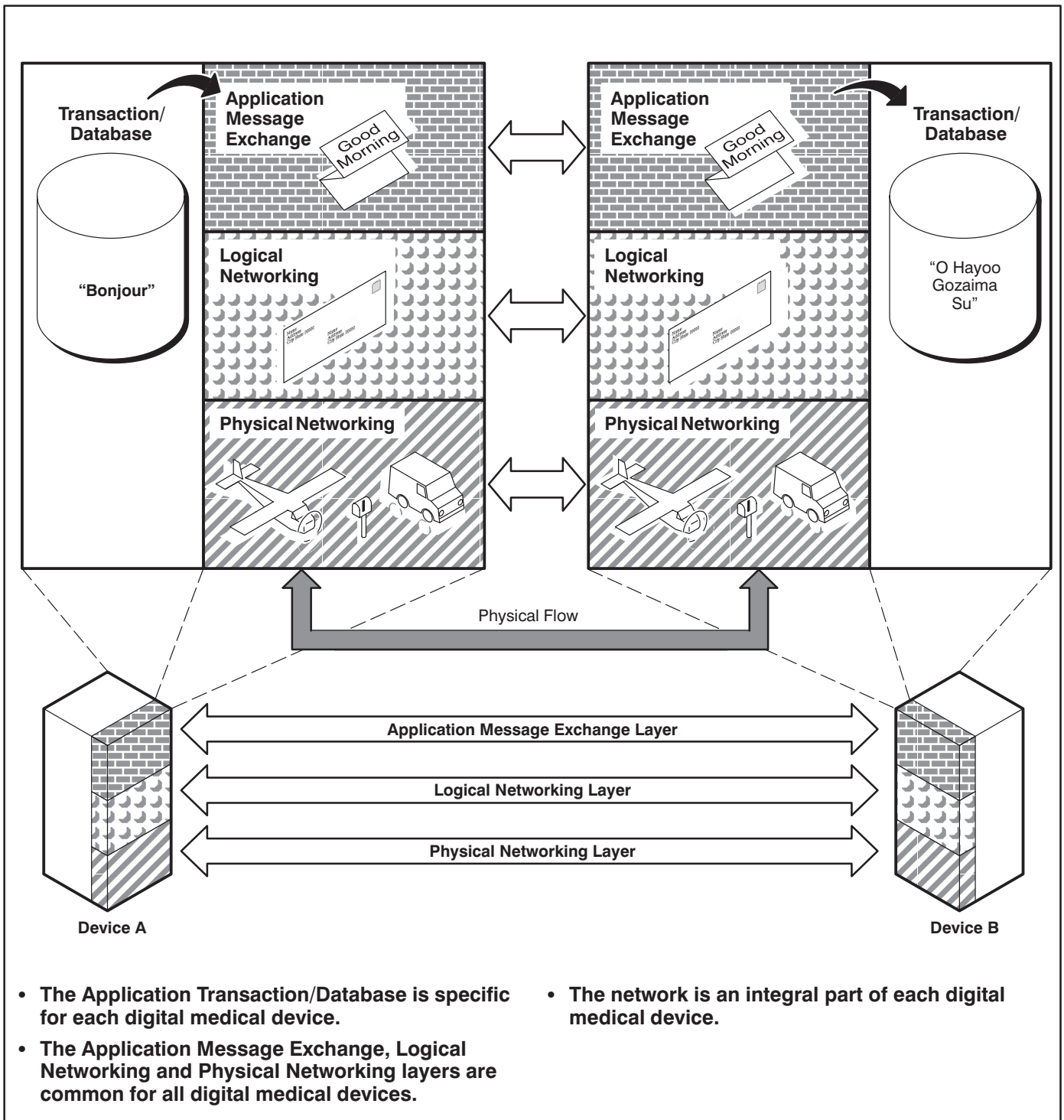

GE ID/Net is an open network architecture as it relies on network standards broadly supported by the medical industry (e.g., DICOM) and the computer industry (e.g., TCP/IP, Ethernet, OSI, etc.) for all of the networking layers.

### 2-2-2 DICOM and the OSI Reference Model

As stated earlier, DICOM v3.0 is structured according to the OSI Reference Model. The OSI Reference Model defines seven layers of communication protocol which may be more simply grouped into the three layers previously described:

- 1.) Application Message Exchange Layer
- 2.) Logical Networking Layer
- 3.) Physical Networking Layer

DICOM defines one **Application Message Exchange Layer** which may operate over two logical/physical networking protocols:

- 1.) DICOM Upper Layers (UL) with TCP/IP
- 2.) OSI protocol

ID/Net v3.0 has selected the DICOM UL with TCP/IP. Illustration 2-4 shows how the DICOM UL TCP/IP network protocol relates to the OSI Reference Model.

ILLUSTRATION 2-4  
DICOM UL TCP/IP AND OSI LAYERS

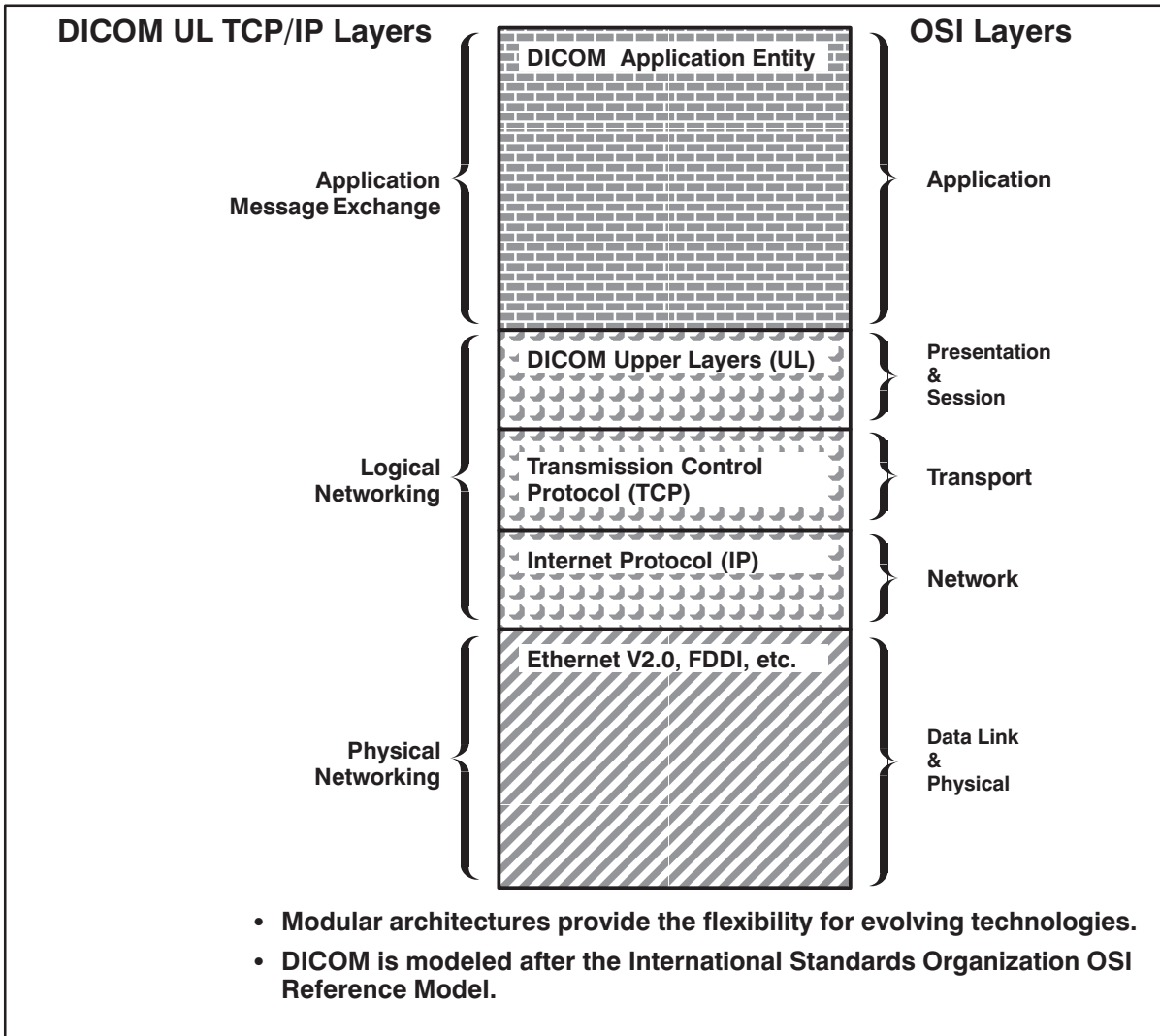

In the Logical Networking Layer the ID/Net architecture uses DICOM UL protocol (standardized by DICOM v3.0 Part 8) and Transmission Control Protocol/Internet Protocol (TCP/IP). TCP is a robust protocol which guarantees reliable delivery of the application messages. IP provides mechanisms which support the routing of data within a hospital or to remote hospitals over a variety of physical networks. The ID/Net Physical Networking Layer generally relies on Ethernet v2.0 as the Datalink and Physical Network Layer. Other physical network technologies may be combined with Ethernet v2.0 (e.g. FDDI or Wide Area Networks (WAN's)).

It should be noted that TCP, IP, and Ethernet are not specific to the DICOM standard and are multi-industry standards implemented in off-the-shelf commercial products. The DICOM Upper Layers (UL) and the DICOM Application Layer are specific to the DICOM standard. The DICOM Application Layer is introduced in more detail in section 3.

**THIS PAGE LEFT INTENTIONALLY BLANK**

## SECTION 3 – APPLICATION LAYER CONCEPTS USED IN DICOM V3.0 AND ID/NET

### 3–1 OVERVIEW

This section of the document describes some of the fundamental concepts and models which are used by the Application layer standardized by DICOM v3.0 and used by ID/Net Implementations. DICOM v3.0 uses Object Oriented Design concepts and the OSI Reference Model.

All parts of the DICOM v3.0 standard were unanimously approved in October of 1993. Part 10 of the DICOM Standard – Media Storage and File Formats, as well as additional parts which are under development as of early 1994, are not discussed in this section.

The reader interested in a complete presentation of these concepts should refer to the DICOM v3.0 standard. The last part in this section provides an overview of the nine DICOM v3.0 Parts.

### 3–2 CONFORMANCE STATEMENTS

A DICOM v3.0 Conformance Statement is available for every piece of GE Imaging Equipment having an ID/Net Interface (as is required by DICOM). The Conformance Statement explicitly states the network capabilities and options implemented by that device. For example, a Conformance Statement identifies which Information Object Definitions (MR image, Patient/Study (RIS) object, etc.) may be sent and/or received. It also identifies which Service Classes have been implemented (Storage, Query/Retrieve, Print, etc.).

The purpose of the Conformance Statement is to define the capabilities of a specific device and allow the reader to determine what exact functionality is available. That is, Conformance Statements allow implementations to assess the level of interoperability between two DICOM compliant devices.

### 3–3 DICOM V3.0 APPLICATION LAYER CONCEPTS

An Application Entity (AE) is an OSI Application Layer function which includes the mechanisms by which applications exchange information on a network. The basic concepts of an Application Entity, as used in the DICOM v3.0 standard, are described in this section (see Ill. 3–1 for a pictorial representation of the DICOM Application Entity).

The DICOM model is based on an object-oriented model. Object-oriented modeling uses abstract data objects (e.g., the definition of MR images, CT images, etc.) to represent a class of real-world objects. Object-oriented modeling also defines generic “methods” (e.g., Store, Delete, Create, Get, etc.) which act upon the data objects. The combination of a method and a data object being used by two peer AEs over an association constitutes an instance of communication. Illustration 3–1 shows the relationship of the DICOM objects model.

ILLUSTRATION 3–1

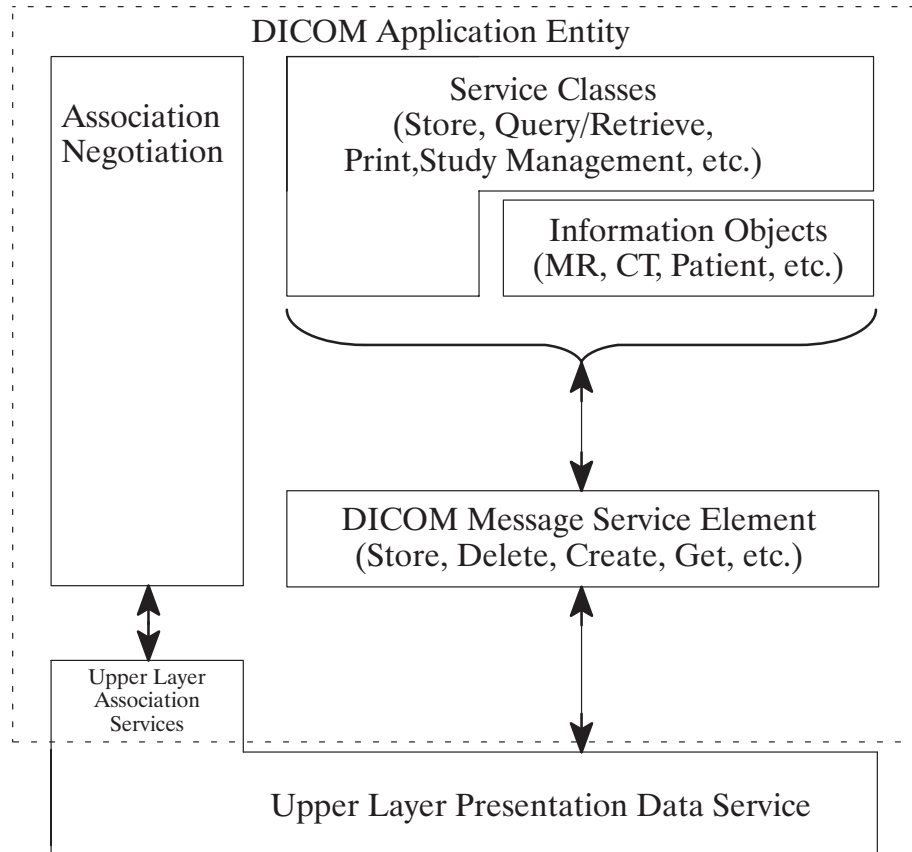
**DICOM OBJECTS RELATIONSHIP MODEL**

An AE uses the following concepts:

- 1.. Information Object Definitions (data object definitions)
- 2.. DICOM Message Service Element Services (generic methods)
- 3.. Service Object Pair (SOP) Classes (the method and data object combined)
- 4.. Service Classes (a set of related SOP Classes)
- 5.. Association Negotiation (negotiate how data will be encoded and the type of data to be exchanged)

Each of these concepts is defined in further detail in sections 3–3–1 through 3–3–5.

### 3–3–1 Information Object Definition

An Information Object Definition (IOD) is the specification used to define an abstract data object (the information to exchange). The goal of an IOD is to provide an unambiguous specification about related pieces of information. IODs do not represent a specific instance of the data object, but rather a class of similar data objects which have the same properties. IODs provide the mechanisms to specify data objects such as images (e.g., MR, CT, NM, etc.) and also image related data objects such as curves, overlays, Radiology Information System (RIS) information, etc.



In DICOM an IOD consists of an Entity Relationship Model, information entities, modules, and attributes. The content of an IOD is similar to a memo. A memo consists of words (called attributes), sentences (a set of related words, called modules), paragraphs (a set of related sentences, called information entities), and finally the memo (a set of related paragraphs, described by an Entity Relationship Model).

### 3-3-2 DICOM Message Service Element (DIMSE) Services

Specifying an IOD is key for communication. However, it is not sufficient. Services (methods) which operate on IODs need to be standardized. DICOM defines a set of generic services (such as Store, Create, Delete, Get, etc.) which act upon instances of an IOD. These services are called the DICOM Message Service Element (DIMSE).

### 3-3-3 Service Object Pair (SOP) Class

The coupling of one or more DIMSE Services with one specific IOD results in a Service Object Pair Class (SOP Class). A SOP Class specification contains the rules which are applied to the DIMSE Services and a related IOD. A SOP Class is equivalent to an “object class” in the object-oriented model (the data plus the methods).

A SOP Class is the key specification building block for the successful communication between two AEs. However, like the IOD, the SOP Class does not represent a specific instance of communication. When a specific instance of communication does occur it is defined as a SOP Instance. SOP Instances are used to represent real-world occurrences of images, studies, patients, etc.

The analogy of a sentence can be used to describe the MR Storage SOP Class. The IOD acts as the noun (an MR image). The DIMSE Service acts as the verb (Store). The SOP Class is similar to a generic sentence (Store an MR image). The SOP Instance is similar to a specific sentence (Store this MR image).

### 3-3-4 Service Class

A Service Class represents a specific function which is to be accomplished by peer AEs and is defined by a set of related SOP Classes. For example, the features needed to query for image information and to retrieve the actual image data are very closely related. To achieve these features two SOP Classes are required, one to gather image information (query) and one to get the image data (retrieve). The Query/Retrieve Service Class combines these related SOP Classes into one Service Class.

The Service Class defines two roles which are used by communicating AEs, the Service Class User (SCU) and Service Class Provider (SCP). These roles are based on the “client/server model”. The SCU acts as the “client” while the SCP acts as the “server”. For example, for the Storage Service Class, the SCU acts as the image send device while the SCP acts as the image receive device.

### 3-3-5 Association Negotiation

Association establishment is the first phase of communication between peer AEs. The AEs use the association establishment to negotiate how data will be encoded and the type of data to be exchanged. Some of these negotiated parameters include Application Context, Abstract Syntaxes, Transfer Syntaxes, and Application Association Information.

The method of negotiation used in DICOM v3.0 is fairly simple. The device which initiates the association proposes a list of possible options for each negotiated parameter. The initiating device must be capable of supporting all of the options which it proposes. The responding device selects which of the options it can support and returns this information to the initiating device. This commonly agreed upon set of options is then available on the corresponding association.

### 3-3-6 Example of AE Concepts

Following is an example of two systems which need to send/receive an MR image. This example illustrates how DICOM is used to achieve this image exchange.

ILLUSTRATION 3-1  
EXAMPLE OF AE CONCEPTS

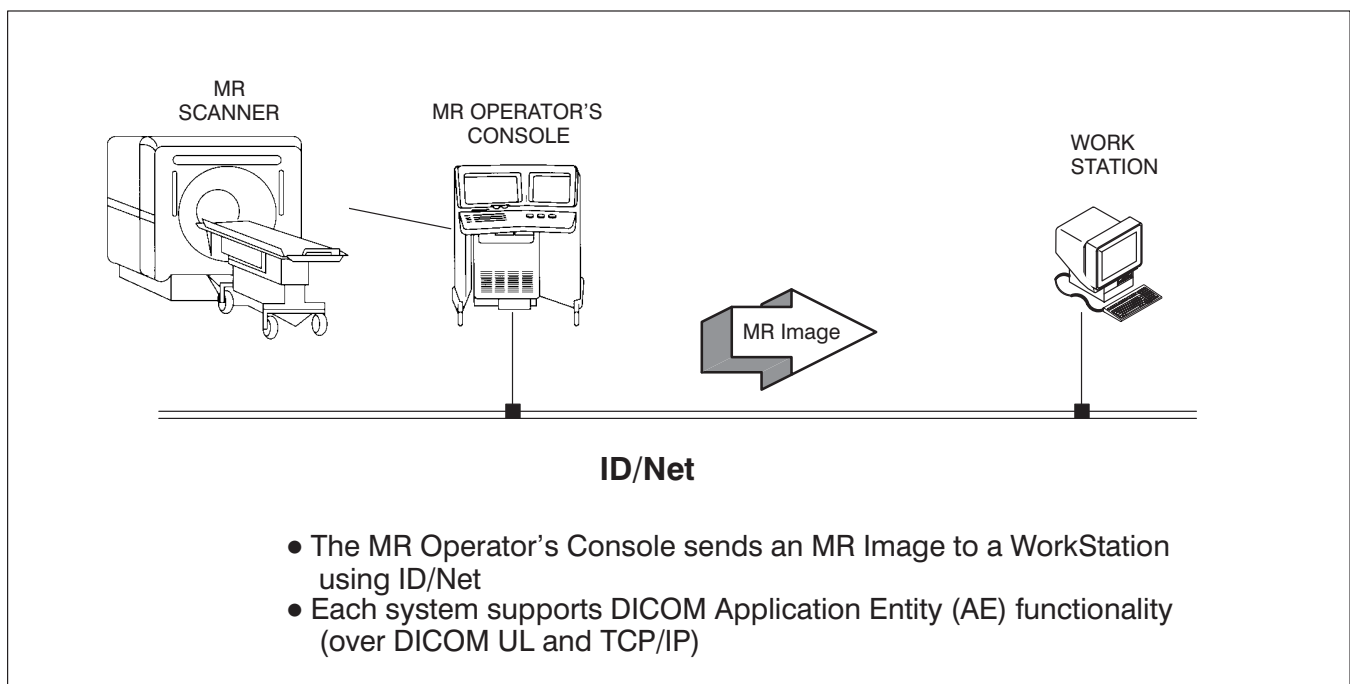

In order to understand how to exchange this MR image, both the MR Scanner and the Workstation need to implement the DICOM Application Entity concepts previously discussed.

To determine the data structure that defines an MR image each device must understand the **MR Image Information Object Definition**.

The MR Image IOD contains the **Attributes** which describe the complete set of data needed to define the image. Some of the Attributes are Patient Name, Date of Scan, MR Acquisition Type, Echo Time, Pixel Data, etc. Associated Attributes are grouped into **Modules**. Modules contain the exact definition of each Attribute, including whether the Attributes are required or optional and the rules of how these Attributes are related. A few of the Modules are: Patient Identification Module, Image Pixel Module, Overlay Plane Module, Lookup Table Module, etc. Associated Modules are grouped into **Information Entities**. The key Information Entities include Patient, Study, Series, Equipment and Image. As an example, the Image Information Entity includes the Image Pixel Module, Overlay Plane Module, and the Lookup Table Module. The relationship of the Information Entities is described by an **Entity Relationship Model** (see Ill. 3-2 for an example of an Entity Relationship Model and DICOM Standard Part 3, section 5 for information on how to interpret Entity relationship diagrams).

ILLUSTRATION 3-2  
MR IMAGE ENTITY RELATIONSHIP DIAGRAM

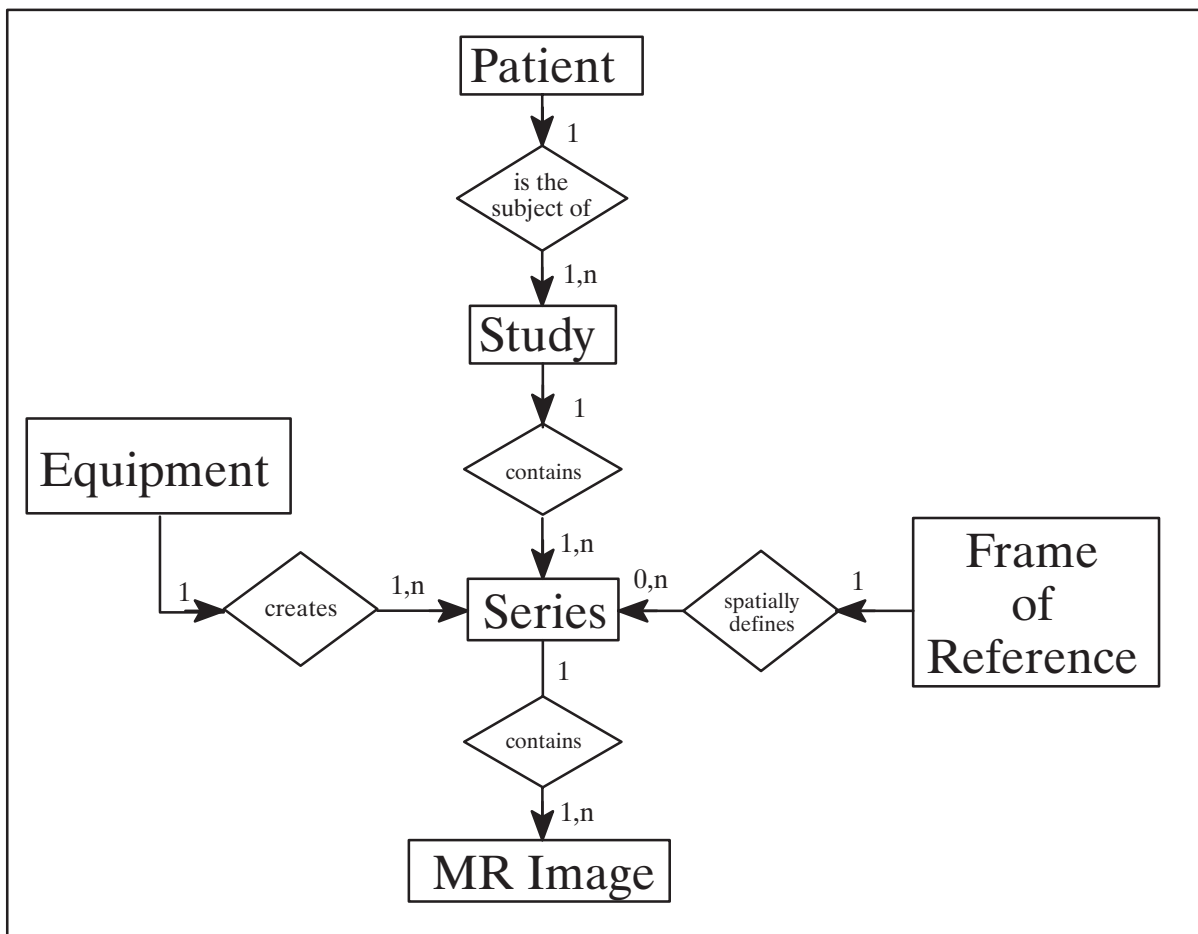

To determine how to send/receive the MR image each device must understand the **C-STORE DIMSE Service**. This is the generic service (method) which is used to send or receive any image, e.g., MR, CT, Nuclear, etc.

To determine how to couple the MR Image IOD and the C–STORE DIMSE Service each device must understand the **MR Storage SOP Class**. In this example, only one DIMSE Service is coupled with the MR Image IOD. However, other examples may include multiple DIMSE Services coupled with one IOD.

The MR Storage Service Class is one of the SOP Classes specified by the DICOM Storage Service Class. Each AE must understand which role it wishes to play for the MR Storage SOP Class. The MR Scanner, which is sending the image, will act as the **Storage Service Class User (SCU)**. The Workstation, which is receiving the image, will act as the **Storage Service Class Provider (SCP)**.

To establish an **Association** between the two devices so the image may be sent, both AE's must understand the negotiation process. Two of the key parameters which will be negotiated during Association Establishment are the **Abstract Syntax** and **Transfer Syntax**. The Abstract Syntax identifies the SOP Class. In this example, the Abstract Syntax is the MR Storage SOP Class (i.e., the MR Image IOD and the C–STORE DIMSE Service). The Transfer Syntax identifies the type of pixel data encoding which will be used to send this image, e.g., compressed or uncompressed pixel data.

In this example, the MR Scanner may initiate the Association by proposing several Abstract and Transfer Syntaxes. The responding Workstation will identify the Syntaxes it can support in its response to the MR Scanner.

### 3–3–6–1 Communication Scenario

Now lets go through the order that the steps occur in the actual transmission of the image.

The MR Scanner first initiates an association to the Workstation. It offers an Abstract Syntax which represents the MR Storage SOP Class with two Transfer Syntaxes, compressed or uncompressed pixel data. The Workstation responds by accepting the MR Storage SOP Class and selecting the uncompressed Transfer Syntax (it could not support compression). The association is now established.

The MR Scanner constructs the image per the MR IOD and uses the C–STORE DIMSE Service to send that IOD. The result will form a message including a command (C–STORE) and a Data Set (the MR IOD encoded Attributes). The actual image or MR Image SOP Instance is identified by a unique identifier or UID (see section 3–4).

The Workstation receives this MR Image SOP Instance and stores the information in it's database. The Workstation returns a "successful" response using the STORE DIMSE Service. The image has now been successfully received.

At this time the MR Scanner may send more images or release the association.

**Note:** The above example illustrates a simple transfer of images. If both the MR Scanner and the Workstation had implemented additional SOP Classes, such as Query/Retrieve, these features could also be used on the same association.

### 3–4 UNIQUE IDENTIFIERS (UIDS)

Unique Identifiers (UIDs) provide the capability to uniquely identify a wide variety of items. It guarantees uniqueness across countries, sites, vendors and equipment. This scheme is used to uniquely identify items such as Service Object Pairs (SOP) Classes, images, instances, network negotiation parameters, etc.

The UID identification scheme is based on the OSI Information Object as defined by the ISO 8824 standard. All UIDs, used within the context of the DICOM Standard, are based upon registered values as defined by ISO 9843-3 to ensure global uniqueness.

There is a root portion of the UID which uniquely identifies GE Medical Systems. The root is registered with ISO and therefore guarantees that GE-specific UIDs are unique among vendors.

Per the DICOM v3.0 standard, three types of UID values are used:

- 1.. The DICOM UID values which are defined in the DICOM Standard (such as SOP class UIDs).
- 2.. GE-specific UID values which are defined in the ID/Net DICOM Conformance Statement for GE products (such as product Implementation Class UID's).
- 3.. GE-specific UID values dynamically generated by GE product implementations (such as Image SOP Instance UIDs).

### 3-5 RELATIONSHIP OF CONCEPTS TO THE PARTS OF THE DICOM V3.0 STANDARDS

DICOM v3.0 is comprised of nine Parts which were balloted and approved in October, 1993. As of early 1994, three additional Parts related to Media Storage and File Format were placed under review. The nine Parts of the DICOM v3.0 Standard and the areas which are covered are:

<b>PART</b>	<b>TITLE</b>
1..	<b>Introduction and Overview</b>
2..	<b>Conformance Requirements</b> Includes requirements for accurately writing a DICOM Conformance Statement.
3..	<b>Information Objects Definitions</b> Includes IODs for MR, CT, Ultrasound, Nuclear, etc. It also includes IOD's for Network Filming and Imaging Study Management (often called HIS/RIS Interfacing).
4..	<b>Service Classes Specifications</b> Includes definitions of Service Class concepts, the SCU/SCP roles, and definitions of Service Classes (i.e. Image Storage, Query/Retrieve, Network Print, Study Management, Results Management, etc.).
5..	<b>Data Structure and Encoding</b> Includes DICOM data set structure, Data Element encoding rules, value encoding definitions (e.g., short string, unsigned short int, etc.), Attribute types, UID encoding rules and registration, and Transfer Syntax specifications. The support of JPEG lossless compression is also fully specified.
6..	<b>Data Dictionary</b> Includes Element list which is made up of Attribute Names and descriptions, Data Element Tags (Group and Element numbers), Value Representations and Multiplicity.
7..	<b>Message Exchange</b> Includes association negotiation information and structures, DIMSE operation and notification rules and DIMSE service and protocol definitions (e.g., C-STORE, C-ECHO).

- 8.. **Network Communication Support for Message Exchange**  
Includes Association Establishment protocol and encoding, including the DICOM Upper Layer protocol used with TCP/IP.
- 9.. **Point-to-point Communication**  
Includes 50-pin hardware specification and communication protocol.  
This is the ACR–NEMA specific hardware interface which was defined in Version 2 of the Standard. It has been included as Part 9 of the DICOM Standard for historical purposes.

## SECTION 4 – REFERENCES

### 4-1 NORMATIVE REFERENCES

- DICOM – Part 1: Document Structure
- DICOM – Part 2: Conformance
- DICOM – Part 3: Information Object Definitions
- DICOM – Part 4: Service Class Specifications
- DICOM – Part 5: Data Structure and Encoding
- DICOM – Part 6: Data Dictionary
- DICOM – Part 7: Message Exchange
- DICOM – Part 8: Network Communication Support for Message Exchange

### 4-2 RELATED PUBLICATIONS OF INTEREST

- DICOM v3.0 Standard (printed copy):  
ACR–NEMA / DICOM Representative  
NEMA  
2101 L Street, NW, Suite 300  
Washington DC 20037  
USA  
(202 457–1965)
- DICOM v3.0 (electronic copy):  
Available through anonymous ftp from Pennsylvania State University  
ftp address: **ftp.xray.hmc.psu.edu**
- SCAR 1994 “Buying Imaging Products with a DICOM Interface – Made Easy”  
Van Syckle, Sippel–Schmidt, Parisot

### 4-3 DICOM SOFTWARE COMMONLY AVAILABLE

DICOM v3.0 Shareware (RSNA 1993 Central Test Node Software) available via anonymous ftp over internet:

- Mallinckrodt Institute of Radiology  
ftp address: **wuerlim.wustl.edu** (128.252.115.18)
- Institute OFFIS, Oldenburg University (Germany), CERIUM in Rennes, France, and CEN/TC251/WG4  
ftp address: **ftp.uni-oldenburg.de**

### 4-4 DEFINITIONS

Many of the terms defined here are used in sections 2 and 3 of this document and in the ID/Net DICOM Conformance Statement of each GEMS product.

**Abstract Syntax:** The Abstract Syntax identifies the Service/Object Pair (SOP) Class which is used when two peer DICOM Application Entities communicate. The Abstract Syntax is negotiated at the time of Association Establishment.

**ACR-NEMA:** A standards body sponsored by the American College of Radiology (ACR) and the National Electrical Manufacturers Association (NEMA).

**Application Context:** An Application Context is a name which is used to identify the use of the DICOM Application Services over an association. It is negotiated between two peers during association establishment.

**Application Entity (AE):** An Application Entity is an OSI Application Layer function which includes the mechanisms by which applications exchange information on a network. Oversimplistically, an AE is a program which contains network communications capabilities and which runs on a computer.

**Association Establishment:** An Association represents a level of connectivity between to AEs. An Association Establishment is the first phase of communication between two peer DICOM AEs. The two peers use this method to negotiate some communication parameters such as Abstract Syntax, Transfer Syntax, etc.

**Attributes:** Attributes are properties which describe an Information Object Definition. An Attribute is identified by a name and its associated Data Element Tag (group and element number).

**Conformance Statement:** The Conformance Statement states which options and features of DICOM have been implemented by a specific product (e.g. which IOD's, which Service Classes, etc.). It specifies in technical detail how a particular implementation meets the conformance requirements set forth by DICOM v3.0. Every device which claims DICOM conformance must openly publish a DICOM conformance statement, written in the format specified by DICOM Part 2.

**Data Element:** A Data Element is an encoded Attribute and is part of a Data Dictionary. The Data Element Tag is used to uniquely identify the piece of information within the Dictionary. An Element Number is combined with a Group Number to make up a tag. For example, Study (Exam) Number is Group 20 Element 10. The group and element number tag are encoded in the Data Set (and, hence, the data stream.)

**DICOM:** The acronym of the final version of the standard produced by the ACR-NEMA committee is officially called: Digital Imaging and Communications in Medicine (DICOM v3.0), and was unanimously approved in October 1993.



**DIMSE:** DICOM Message Service Element. The DICOM v3.0 Standard defines the services and protocols used by an Application Entity to exchange messages. These services and protocols define the DICOM Message Service Element (DIMSE). DIMSE defines generic “operations” (such as Store, Move, Find, Get, etc.) which can be used in specifying SOP Classes. DIMSE are defined in DICOM v3.0 Part 7.

**Element:** Informal term used to reference a Data Element.

**Full Fidelity Storage:** The characteristic of a receiving device to be able to receive and store all attributes, including private attributes, specified for a given Image Information Object Definition.

**Group:** A Group is a collection of data elements within a message and is part of a Data Dictionary Tag (see Tag).

**Information Entity:** An Information Entity is a subset of an Information Object Definition (e.g., CT image or MR image). It is a group of related Modules.

**Information Object:** Informal term used to reference an Information Object Definition.

**Information Object Definition (IOD):** An IOD is a data model which is an abstraction of real-world information (e.g., an MR Image or CT Image) and which is acted upon by one or more DIMSE operations. An IOD consists of a data model describing the interpretation of the information and the attributes which define it.

**Module:** A Module is a set of Attributes within an Information Object which are logically related to each other. For example, the “Patient Identification Module” may be defined by the following attributes: Patient Name, Patient ID, and Patient Birthdate, and Patient Sex.

**Service Class:** A Service Class defines a specific function which is to be accomplished by connecting AEs. A Service Class specifies a set of one or more Service/Object Pairs (SOP) which perform a function across a network and provide interoperability between two application entities. Examples of a Service Class include image storage, query/retrieve, etc.

**Service Class Provider (SCP):** A Service Class Provider acts in a “server” role to the Service Class during a network communications exchange. An SCP performs operations requested by an SCU and may also provide notifications to the SCU. An example of a **Storage** Service Class Provider would be the image storage device. In this case, the image storage device is storing the image as requested by the SCU.

**Service Class User (SCU):** A Service Class User acts in a “client” role to the Service Class during a network communications exchange. An SCU requests that an SCP perform operations. An example of a **Storage** Service Class User would be the image send device. In this case, the image send device will send an image by requesting the SCP to store that image.

**Service/Object Pair (SOP) Class:** A SOP Class is defined by the union of an IOD and a DIMSE Service Group. The SOP Class definition contains the rules and semantics which may extend or restrict the definitions of the DIMSE Service Group or the IOD attributes. A DICOM Application Entity may support one or more SOP Classes. Each SOP Class is identified by a SOP Class UID.

**SOP Instance:** A representation of a specific occurrence of a SOP class.

**Tag:** The Tag is used to uniquely identify information within a Data Dictionary. A Group Number is combined with an Element Number to make up a tag. For example, Study (Exam) Number is Group 20 Element 10. The group and element number tag are encoded in the data stream. In v2.0, the Group was used to convey semantic information (e.g., Group 10 is Image Information). However, in DICOM v3.0 the Group semantic information has been replaced with the Module concept.

**Transfer Syntax:** The Transfer Syntax represents the type of data encoding which is used when two peer DICOM Application Entities communicate. The Transfer Syntax is negotiated at the time of Association Establishment. Examples of Transfer Syntaxes are Little Endian, Big Endian, JPEG lossless compression, etc.

**Unique Identifier (UID):** A Unique Identifier is a method which is used to create a globally unique ASCII-numeric string. It guarantees uniqueness across multiple countries, sites, vendors and equipment. The UID encoding method which is used in DICOM v3.0 is ISO compliant. A few examples for uses of UIDs are SOP Class UID, Image UID, network negotiation parameters, etc.

**Upper Layer (UL):** The Upper Layer is part of the DICOM Logical Network Layer of software. The Upper Layer performs such functions as the Association Establishment (including Abstract and Transfer Syntax negotiation), the encoding and decoding of a DICOM message stream, etc.

#### 4-5 SYMBOLS AND ABBREVIATIONS

<b>ACC</b>	American College of Cardiology
<b>ACR</b>	American College of Radiology
<b>AE</b>	Application Entity
<b>ANSI</b>	American National Standards Institute
<b>DICOM</b>	Digital Imaging and Communications in Medicine
<b>DIMSE</b>	DICOM Message Service Element
<b>GEMS</b>	GE Medical Systems
<b>HIS</b>	Hospital Information System
<b>ID/NET</b>	Integrated DICOM/Network
<b>IOD</b>	Information Object Definition
<b>IS&amp;C</b>	Image Save & Carry
<b>ISO</b>	International Standards Organization
<b>JIRA</b>	Japanese Industry Radiology Aparatus
<b>NEMA</b>	National Electrical Manufacturers Association
<b>OSI</b>	Open Systems Interconnection
<b>RIS</b>	Radiology Information System
<b>SCP</b>	Service Class Provider

- SCU**    Service Class User
- SOP**    Service/Object Pair
- TCP/IP**    Transmission Control Protocol/Internet Protocol
- UID**    Unique Identifier
- UL**    Upper Layer

**THIS PAGE LEFT INTENTIONALLY BLANK**





---

## **GE Medical Systems**

*GE Medical Systems: Telex 3797371  
P.O. Box 414, Milwaukee, Wisconsin 53201 U.S.A.  
(Asia, Pacific, Latin America, North America)*

*GE Medical Systems — Europe: Telex 698626  
283, rue de la Minière, B.P. 34, 78533 Buc Cedex  
France*



**GE Medical Systems**

---

# **Technical Publications**

**Direction 2142506–100**

**Revision 6**

**Advantx DLX**

**Dicom V3.0 (ID/NET V3.0) (ID/NET V3.0)**

**Dicom Conformance Statement**

**This document applies to DLX  
Release C19.XX**

**do not duplicate**

**Copyright © 1995 by General Electric Co.**

Blank page



## TABLE OF CONTENTS

SECTION	TITLE	PAGE
	REVISION HISTORY .....	v
	LIST OF EFFECTIVE PAGES .....	v
<b>SECTION 1 – INTRODUCTION .....</b>		<b>1-1</b>
1-0	OVERVIEW .....	1-1
1-1	OVERALL Conformance Statement DOCUMENT STRUCTURE .....	1-1
1-2	INTENDED AUDIENCE .....	1-3
1-3	scope and field of application .....	1-4
1-4	important remarks .....	1-4
1-5	references .....	1-5
1-6	definitions .....	1-5
1-7	symbols and abbreviations .....	1-5
<b>SECTION 2 – CONFORMANCE STATEMENT .....</b>		<b>2-1</b>
2-0	introduction .....	2-1
2-1	IMPLEMENTation model .....	2-1
2-1-1	Application Data Flow Diagram .....	2-1
2-1-2	Functional Definition of AE’s .....	2-2
2-1-3	Sequencing of Real-World Activities .....	2-2
2-2	AE Specifications .....	2-2
2-2-1	AE Specification .....	2-2
2-2-1-1	Association Establishment Policies .....	2-3
2-2-1-1-1	General .....	2-3
2-2-1-1-2	Number of Associations .....	2-3
2-2-1-1-3	Asynchronous Nature .....	2-3
2-2-1-1-4	Implementation Identifying Information .....	2-4
2-2-1-2	Association Initiation Policy .....	2-4
2-2-1-2-1	Real-World Activity ”Copy Image” .....	2-4
2-2-1-2-1-1	Associated Real-World Activity .....	2-4
2-2-1-2-1-2	Proposed Presentation Contexts .....	2-4
2-2-1-2-1-2-1	SOP Specific Conformance Statement for Image Storage SOP Class .....	2-4
2-2-1-2-2	Real-World Activity ”Get Worklist” .....	2-5
2-2-1-2-2-1	Associated Real-World Activity .....	2-5
2-2-1-2-2-2	Proposed Presentation Contexts .....	2-5
2-2-1-2-2-2-1	SOP Specific Conformance Statement for Worklist SOP Class .....	2-5
2-2-1-2-3	Real-world Activity ”Verification” .....	2-6

2-2-1-2-3-1 Associated Real-World Activity .....	2-6
2-2-1-2-3-2 Proposed Presentation contexts .....	2-6
2-2-1-3 Association Acceptance Policy .....	2-6
2-2-1-3-1 Real-World Activity "Verification acknowledge" .....	2-7
2-2-1-3-1-1 Associated Real-World Activity .....	2-7
2-2-1-3-1-2 Accepted Presentation Contexts .....	2-7
2-2-1-3-1-2-1 SOP Specific Conformance Statement for Verification SOP Class .....	2-7
2-3 Communication profiles .....	2-8
2-3-1 Supported Communication Stacks (parts 8,9) .....	2-8
2-3-2 TCP/IP Stack .....	2-8
2-3-2-1 API .....	2-8
2-3-2-2 Physical Media Support .....	2-8
2-3-3 Point-to-Point Stack .....	2-8
2-4 Extensions / specializations / privatizations .....	2-8
2-5 Configuration .....	2-8
2-5-1 AE Title/Presentation Address Mapping .....	2-8
2-5-2 Configurable Parameters .....	2-8
2-6 Support of extended character sets .....	2-8

**SECTION 3 XA INFORMATION OBJECT IMPLEMENTATION ..... 3-1**

3-0 Introduction .....	3-1
3-1 XA Image IOD Implementation .....	3-1
3-2 XA Image IOD Entity-Relationship Model .....	3-1
3-2-1 Entities Description .....	3-2
3-2-2 DLX Mapping of DICOM entities .....	3-2
3-3 XA Image IOD Module Table .....	3-2
3-4 InFORMATION MODULE DEFINITIONS .....	3-3
3-4-1 Patient Entity Module .....	3-3
3-4-1-1 Patient Module .....	3-3
3-4-2 Study Entity Module .....	3-4
3-4-2-1 General Study .....	3-4
3-4-2-2 Patient Study .....	3-4
3-4-3 Series Entity Module .....	3-4
3-4-3-1 General Series .....	3-4
3-4-4 Equipment Entity Module .....	3-5
3-4-4-1 General Equipment .....	3-5
3-4-5 Image Entity Module .....	3-5
3-4-5-1 General Image .....	3-5
3-4-5-2 Image Pixel .....	3-6
3-4-5-3 Cine .....	3-6
3-4-5-4 Multi-Frame .....	3-6

3-4-5-5 Frame Pointers .....	3-6
3-4-5-6 Mask .....	3-7
3-4-5-7 Display Shutter .....	3-7
3-4-5-8 Device .....	3-7
3-4-5-9 X-Ray Image .....	3-8
3-4-5-10 X-Ray Acquisition .....	3-8
3-4-5-11 X-Ray Collimator .....	3-10
3-4-5-12 XA Positioner .....	3-10
3-4-5-13 X-Ray table .....	3-11
3-4-5-14 Curve .....	3-11
3-4-5-15 SOP Common .....	3-11
3-5 PRIVATE DATA DICTIONARY .....	3-12

**SECTION 4 – SECONDARY CAPTURE IMPLEMENTATION ..... 4-1**

4-0 Introduction .....	4-1
4-1 SC Image IOD Implementation .....	4-1
4-2 SC Image IOD Entity-Relationship Model .....	4-1
4-2-1 Entities Description .....	4-2
4-2-2 DLX Mapping of DICOM entities .....	4-3
4-3 SC Image IOD Module Table .....	4-3
4-4 Module Library .....	4-3
4-4-1 Patient Entity Module .....	4-4
4-4-1-1 Patient Module .....	4-4
4-4-2 Study Entity Module .....	4-4
4-4-2-1 General Study .....	4-4
4-4-2-2 Patient Study .....	4-4
4-4-3 Series Entity Module .....	4-4
4-4-3-1 General Series .....	4-4
4-4-4 Equipment Entity Module .....	4-5
4-4-4-1 SC Equipment Module .....	4-5
4-4-5 Image Entity Module .....	4-5
4-4-5-1 General Image .....	4-5
4-4-5-2 Image Pixel .....	4-6
4-4-5-3 Overlay Plane Module .....	4-6
4-4-5-4 SOP Common .....	4-6
4-5 PRIVATE DATA DICTIONARY FOR SECONDARY CAPTURE .....	4-7

**SECTION 5 – BASIC WORKLIST MANAGEMENT IMPLEMENTATION ..... 5-1**

5-0 INTRODUCTION .....	5-1
5-1 WORKLIST INFORMATION MODEL IMPLEMENTATION .....	5-1
5-2 WORKLIST INFORMATION MODEL ENTITY – RELATIONSHIP DIAGRAM ..	5-1

5-2-1	Entities Description .....	5-2
5-3	Basic Worklist Information Module Table .....	5-2
5-4	INFORMATION MODULE DEFINITIONS .....	5-3
5-4-1	Patient Entity Module .....	5-3
5-4-1-1	Patient Identification Module .....	5-3
5-4-1-2	Patient Demographic Module .....	5-3
5-4-1-3	Patient Medical Module .....	5-3
5-4-2	Visit/Facility Episode Entity Module .....	5-4
5-4-2-1	Visit Identification Module .....	5-4
5-4-2-2	Visit Status Module .....	5-4
5-4-2-3	Visit Relationship Module .....	5-4
5-4-3	Imaging Service Request Entity Module .....	5-5
5-4-3-1	Imaging Service Request Module .....	5-5
5-4-4	Requested Procedure Entity Module .....	5-5
5-4-4-1	Requested Procedure Module .....	5-5
5-4-5	Scheduled Procedure Step Entity Module .....	5-6
5-4-5-1	Scheduled Procedure Step Module .....	5-6
5-4-5-2	SOP Common Module .....	5-6

### REVISION HISTORY

REV	DATE	REASON FOR CHANGE
0	Nov. 24, 1995	Initial release to Direction Stock.
1	April, 1997	Basic Worklist Management Implementation for HIS/RISPatient/Study data retrieval parts of Section 2 and the complete Section 5
2	November 1997	Release updated for coherence with software.
3	June 1998	Release updated for corrections and Worklist query model. Add code meaning for Reverse_Sweep field.
4	April 1999	Title page updated with "This document applies to DLX Release C16.12 and C17.12"
5	July 1999	Title page updated with "This document applies to DLX Release C18.XX"
6	February 2000	Title page updated with "This document applies to DLX Release C19.XX". Real-world Activity "Verification" added.

### LIST OF EFFECTIVE PAGES

PAGE NUMBER	REVISION NUMBER	PAGE NUMBER	REVISION NUMBER	PAGE NUMBER	REVISION NUMBER
Title Page	6				
Table of Contents i thru iv	6				
Revision History v thru vi	6				
Introduction 1-1 thru 1-6	6				
Conformance Statement 2-1 thru 2-8	6				
ADVANTX DLX3 Information Object Definition 3-1 thru 3-12	6				
Secondary Capture Implementation 4-1 thru 4-8	6				
Basic Worklist Management Implementation 5-1 thru 5-4	6				



## SECTION 1 – INTRODUCTION

### 1–0 OVERVIEW

**Section 1, *Introduction***, provides general information about the content and scope of this document.

**Section 2, *Conformance Statement***, is the DICOM v3.0 Conformance Statement related to this product. Conformance Statements defines the subset of options selected from those offered by the DICOM v3.0 standard.

**Section 3, *DLX3 XRAY Angiographic Information Object Implementation*** defines the technical specifications required to interoperate with a DICOM v3.0 network interface. They define the technical details of the Information Object Definitions (IOD's) listed in the Conformance Statement. This section contains also the description of the private elements used in this implementation.

**Section 4, *Secondary Capture Image Information Object implementation***, defines the technical specifications required to interoperate with a DICOM v3.0 network interface. They define the technical details of the Information Object definition (IOD's) listed in the Conformance statement. This section contains also the description of the private elements used in this implementation.

**Section 5, *Basic Worklist Management Implementation***, defines the technical specifications required to interoperate with a DICOM v3.0 network interface. They define the technical details of the Information Object Definitions (IOD's) listed in the Conformance Statement.

### 1–1 OVERALL CONFORMANCE STATEMENT DOCUMENT STRUCTURE

The Documentation Structure of the ID/Net v3.0 Conformance Statements and their relationship with the DICOM v3.0 Conformance Statements is shown in Illustration 1–1.

ILLUSTRATION 1-1  
DOCUMENTATION STRUCTURE

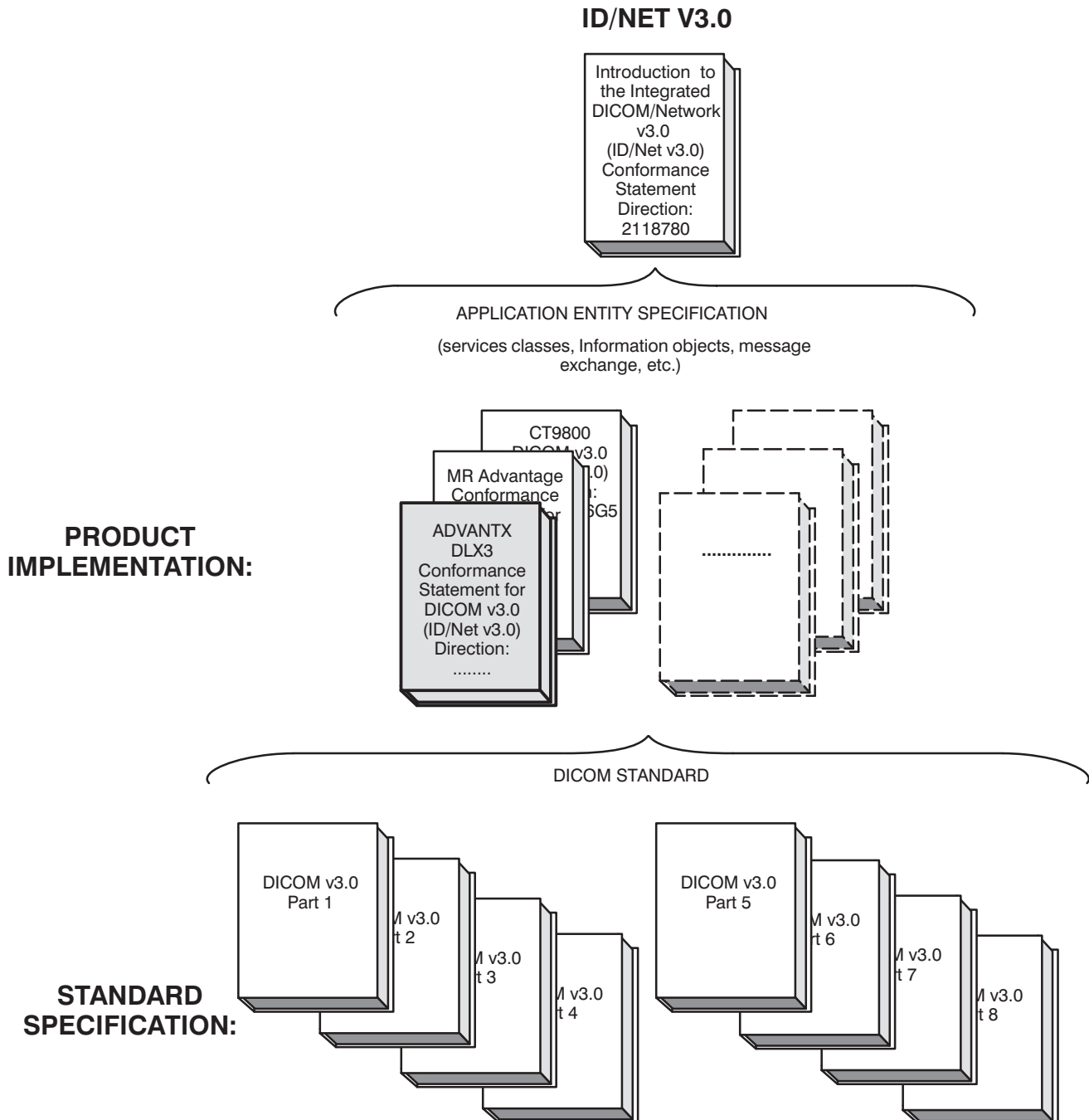



This document specifies the DICOM v3.0 implementation. It is entitled:

*ADVANTX DLX  
Conformance Statement for DICOM v3.0 (ID/Net v3.0)  
Direction .....# 2142506–100*

This Conformance Statement documents the DICOM v3.0 Conformance Statement and Technical Specification required to interoperate with the GEMS ID/Net v3.0 network interface. Introductory information, which is applicable to all GEMS ID/Net v3.0 Conformance Statements, is described in the document:

*Introduction to the Integrated DICOM/Network v3.0 (ID/Net v3.0)  
Conformance Statement  
Direction: 2118780.*

This Introduction familiarizes the reader with DICOM terminology and general concepts. It should be read prior to reading the individual products' ID/Net v3.0 Conformance Statements.

The ID/Net v3.0 Conformance Statement, contained in this document, also specifies the Lower Layer communications which it supports (e.g., TCP/IP). However, the Technical Specifications are defined in the DICOM v3.0 Part 8 standard.

For more information including Network Architecture and basic DICOM concepts, please refer to the *Introduction*.

For the convenience of software developers, there is "collector" Direction available. By ordering the collector, the Introduction described above and all of the currently published ID/Net v3.0 Product Conformance Statements will be received. The collector Direction is:

*ID/Net v3.0 Conformance Statements  
Direction: 2117016*

For more information regarding DICOM v3.0, copies of the Standard may be obtained by written request or phone by contacting:

NEMA Publication  
2101 L Street, N.W., Suite 300  
Washington, DC 20037 USA  
Phone: (202) 457–8474

## 1–2

### INTENDED AUDIENCE

The reader of this document is concerned with software design and/or system integration issues. It is assumed that the reader of this document is familiar with the DICOM v3.0 Standards and with the terminology and concepts which are used in those Standards.

If readers are unfamiliar with DICOM v3.0 terminology they should first refer to the document listed below, then read the DICOM v3.0 Standard itself, prior to reading this Conformance Statement document.

*Introduction to the Integrated DICOM/Network v3.0 (ID/Net v3.0)  
Conformance Statement  
Direction: 2118780*

### 1–3 SCOPE AND FIELD OF APPLICATION

It is the intent of this document, in conjunction with the *Introduction to the Integrated DICOM/Network v3.0 (ID/Net v3.0) Conformance Statement, Direction: 2118780*, to provide an unambiguous specification for GEMS ID/Net v3.0 implementations. This specification, called a Conformance Statement, includes a DICOM v3.0 Conformance Statement and is necessary to ensure proper processing and interpretation of GEMS medical image data exchanged using DICOM v3.0. The GEMS ID/Net v3.0 Conformance Statements are available to the public.

The reader of this Conformance Statement should be aware that different GEMS devices are capable of using different Information Object Definitions. For example, a GEMS CT Scanner may send images using the CT Information Object, MR Information Object, Secondary Capture Object, etc.

Included in this Conformance Statement are the Module Definitions which define all data elements used by this GEMS ID/Net v3.0 implementation. If the user encounters unspecified private data elements while parsing a GEMS Data Set, the user is well advised to ignore those data elements (per the DICOM v3.0 standard). Unspecified private data element information is subject to change without notice. If, however, the device is acting as a "full fidelity storage device", it should retain and retransmit all of the private data elements which are sent by GEMS devices.

### 1–4 IMPORTANT REMARKS

The use of these Conformance Statements, in conjunction with the DICOM v3.0 Standards, is intended to facilitate communication with GE imaging equipment. However, **by itself, it is not sufficient to ensure that inter–operation will be successful.** The **user (or user’s agent)** needs to proceed with caution and address at least four issues:

- **Integration** – The integration of any device into an overall system of interconnected devices goes beyond the scope of standards (DICOM v3.0), and of this introduction and associated Conformance Statements when interoperability with non–GE equipment is desired. The responsibility to analyze the applications requirements and to design a solution that integrates GE imaging equipment with non-GE systems is the **user’s** responsibility and should not be underestimated. The **user** is strongly advised to ensure that such an integration analysis is correctly performed.
- **Validation** – Testing the complete range of possible interactions between any GE device and non-GE devices, before the connection is declared operational, should not be overlooked. Therefore, the **user** should ensure that any non-GE provider accepts full responsibility for all validation required for their connection with GE devices. This includes the accuracy of the image data once it has crossed the interface between the GE imaging equipment and the non-GE device and the stability of the image data for the intended applications. Such a validation is required before any clinical use (diagnosis and/or treatment) is performed. It applies when images acquired on GE imaging equipment are processed/displayed on a non–GE device, as well as when images acquired on non–GE equipment is processed/displayed on a GE console or workstation.

- **Future Evolution** – GE understands that the DICOM Standard will evolve to meet the user’s growing requirements. GE is actively involved in the development of the DICOM v3.0 Standard. DICOM v3.0 will incorporate new features and technologies and GE may follow the evolution of the Standard. ID/Net v3.0 is based on DICOM v3.0 as specified in each ID/Net DICOM Conformance Statement. Evolution of the Standard may require changes to devices which have implemented DICOM v3.0. **In addition, GE reserves the right to discontinue or make changes to the support of communications features (on its products) reflected on by these ID/Net DICOM Conformance Statements.** The user should ensure that any non-GE provider, which connects with GE devices, also plans for the future evolution of the DICOM Standard. Failure to do so will likely result in the loss of function and/or connectivity as the DICOM Standard changes and GE Products are enhanced to support these changes.
- **To be kept informed of the evolution of the implementation described in this document, the User should register on the GE Internet Server, accessible via anonymous ftp, by entering his e–mail address (GE Internet Server Address: ftp.med.ge.com, 192.88.230.11)**
- **Interaction** – It is the sole responsibility of the **non-GE provider** to ensure that communication with the interfaced equipment does not cause degradation of GE imaging equipment performance and/or function.

**1–5****REFERENCES**

A list of references which is applicable to all ID/Net v3.0 Conformance Statements is included in the *Introduction to the Integrated DICOM/Network v3.0 (ID/Net v3.0) Conformance Statement, Direction: 2118780.*

The information object implementation refers to the XRAY Angiographic Image Object Definition (DICOM v3.0 Standart Supplement 6) to Part 3 (Information Object Definition)

**1–6****DEFINITIONS**

A set of definitions which is applicable to all ID/Net v3.0 Conformance Statements is included in the *Introduction to the Integrated DICOM/Network v3.0 (ID/Net v3.0) Conformance Statement, Direction: 2118780.*

**1–7****SYMBOLS AND ABBREVIATIONS**

A list of symbols and abbreviations which is applicable to all ID/Net v3.0 Conformance Statements is included in the *Introduction to the Integrated DICOM/Network v3.0 (ID/Net v3.0) Conformance Statement, Direction: 2118780.*

**THIS PAGE LEFT INTENTIONALLY BLANK**

## SECTION 2 – CONFORMANCE STATEMENT

### 2-0 INTRODUCTION

This conformance statement (CS) specifies the GE Advantx DLX compliance to DICOM v3.0. It details the DICOM Service Classes and roles which are supported by this product.

Advantx DLX is an Integrated Digital Vascular Imaging System for both Angiography and Cardiac applications. It uses DICOM services to export images to remote workstations

Note that the format of this section strictly follows the format of DICOM Standard Part 2 (Conformance) Annex A. Please refer to that part of the standard while reading this section.

### 2-1 IMPLEMENTATION MODEL

#### 2-1-1 Application Data Flow Diagram

The Basic and Specific Application models for this device are shown in Ill. 2-1 .

ILLUSTRATION 2-1  
SPECIFIC AE APPLICATION MODEL

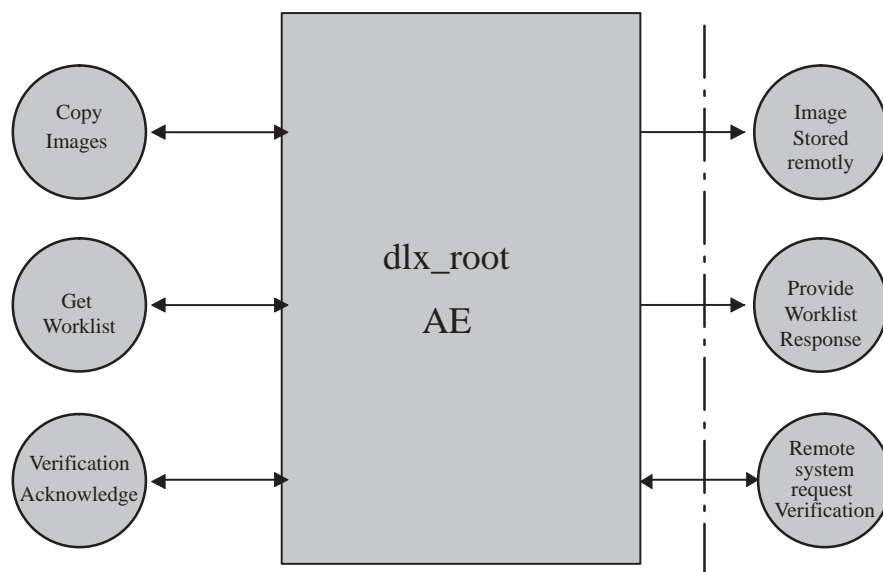

The dlx\_root Application Entity (AE) is an application which handles DICOM protocol communication. dlx\_root AE is automatically brought up when the Digital Angiographic system (DLX) is powered on.

All remote DICOM's AE must be manually configured on the DLX, usually at the software installation time, by a GE field engineer.

There are 3 local real world activities: Copy Image (CI), Get Worklist (GW) and Verification which can cause the dlx\_root AE to initiate a DICOM association.

CI consists of an operator selecting one or several images to be sent on one or several Remote System(s). Selection of Images is done from the Operator console screens (known as BROWSER and VIEWER); selection of Remote Systems and visualisation of the status of the transfer is done on a specific menu (known as TRANSFER menu) . Remote Workstation can be any DICOM compliant WorkStation.

GW consists of an operator request for the transfer of a list of Patient/Exam entries from a predefined remote HIS/RIS system. There is no query key set for subselection of items. The current implementation asks for all data prepared for transfer to DLX. The remote workstation can be any DICOM compliant HIS/RIS system supporting XA modality.

Verification consists of an operator request for the verification of the availability of a remote station.

**2-1-2 Functional Definition of AE's**

The dlx\_root Application Entity supports the following three SCU functions (one at a time):

1. Copy Images:
  - Access to patient demographics and Pixel Data in the local database.
  - Build a DICOM format data set.
  - Initiate a DICOM association to send the image(s).
  
2. Get Worklist:
  - Build a DICOM formatted basic worklist management data request.
  - Initiate a DICOM association to send the request.
  - Wait for worklist response(s).
  - Access the local database to add new patient/exam demographic data.
  - Close the open Association.
  
3. Verification
  - Initiate a DICOM association
  - Close the association

The dlx\_root Application Entity also serves a default SCP function, the verification (Echo) Service Class request, independently from the other SCU functions.

**2-1-3 Sequencing of Real-World Activities**

Not Applicable

**2-2 AE SPECIFICATIONS**

**2-2-1 AE Specification**

This Application Entity provides Standard Conformance to the following DICOM V3.0 SOP Classes as an SCU:

SOP Class Name	SOP Class UID
X-Ray Angiographic Image Storage	1.2.840.10008.5.1.4.1.1.12.1
Secondary Capture Image Storage	1.2.840.10008.5.1.4.1.1.7
Modality Worklist	1.2.840.10008.5.1.4.31
Verification	1.2.840.10008.1.1

X-Ray Angiographic Image Storage is implemented as a Standard Extended SOP Class. It contains type 3 private Data Elements.

Standard conformance as an SCP is not applicable for this Application Entity.

This Application Entity provides Standard Conformance to the following DICOM V3.0 SOP Class as an SCP :

SOP Class Name	SOP Class UID
Verification Service Class	1.2.840.10008.1.1

**2-2-1-1 Association Establishment Policies**

**2-2-1-1-1 General**

The DICOM Application Context Name (ACN), which is always proposed, is:

<b>Application Context Name</b>	<b>1.2.840.10008.3.1.1.1</b>
---------------------------------	------------------------------

The Maximum Length PDU negotiation is included in all association establishment requests.

The maximum length PDU for an association initiated by the dlx\_root AE is:

<b>Maximum Length PDU</b>	<b>16 Kbytes</b>
---------------------------	------------------

The SOP class Extended Negotiation is not supported.

The maximum number of Presentation Contexts Items that will be proposed is 2.

The user info items sent by this product are:

- Maximum PDU Length
- Implementation UID

**Note:** Max PDU length can be configured at installation time.

**2-2-1-1-2 Number of Associations**

The dlx\_root AE will Initiate only one DICOM association to perform an image storage or a Worklist transfer as an SCU to a remote host.

The dlx\_root AE will not support multiple SCU associations simultaneously. The verification SCP association can be open simultaneously to another SCU association.

**2-2-1-1-3 Asynchronous Nature**

Asynchronous mode is not supported. All operations will be performed synchronously.

**2-2-1-1-4 Implementation Identifying Information**

The Implementation UID for this ID/Net v3.0 Implementation is:

<b>AdvantX DLX Implementation UID</b>	<b>1.2.840.113619.6.33</b>
---------------------------------------	----------------------------

**2-2-1-2 Association Initiation Policy**

dlx\_root AE attempts to initiate a new association for each image it attempts to transfer. This association corresponds to one Real-World Activity: Copy Image(CI) or Get Worklist (GW).

**2-2-1-2-1 Real-World Activity "Copy Image"**

**2-2-1-2-1-1 Associated Real-World Activity**

The operator selects a destination by selecting an Host in the 'TRANSFER' menu (by default the last selected host is active).

Then he selects Image(s) to be sent by selection in both BROWSER (at patient level), or VIEWER (at sequence or photo level).

This operation will cause

- the dlx\_root AE to initiate a DICOM association.
- the dlx\_root AE to emit a C-ECHO command to check if the remote AE is available.
- the DLX to build a DICOM image from its compressed raw data
- the dlx\_root AE to initiate a DICOM association, select the appropriate Abstract and Transfer syntax from those accepted by the remote AE
- the dlx\_root AE to emit C-STORE command to send the image.

**2-2-1-2-1-2 Proposed Presentation Contexts**

Presentation Context Table – Proposed					
Abstract Syntax		Transfer Syntax		Role	Expanded Negotiation
Name	UID	Name List	UID List		
XRAY Angio Image Storage	1.2.840.10008.5.1.4.1.1.12.1	Implicit VR Little Endian	1.2.840.10008.1.2	SCU	None
Secondary Capture Image Storage	1.2.840.10008.5.1.4.1.1.7	Implicit VR Little Endian	1.2.840.10008.1.2	SCU	None

**2-2-1-2-1-2-1 SOP Specific Conformance Statement for Image Storage SOP Class**

This implementation performs a single C-STORE operation over an association.

If the AE doesn't receive a C-ECHO confirmation, this implementation will terminate the association. The transfer is considered as failed, no association for C-STORE will be attempted.

Upon receiving a C-ECHO confirmation containing an Error, Refused or Warning status, this implementation will consider the result as OK. This is because the only purpose of the C-ECHO is to check that the remote AE responds, whatever is the C-ECHO status. This implementation doesn't require that remote AE implements Verification SOP class as a SCP.



Upon receiving a C-STORE confirmation containing an Error or a Refused status, this implementation will terminate the association. The current C-STORE is considered as failed.

Upon receiving a C-STORE confirmation containing a Warning Status, this implementation will treat it as an Error or Refused response.

Each C-STORE operation supports an “ Association Timer ”. This timer starts when the association request is sent and stops when the association is established. This timer is set to 60 seconds.

Each C-STORE operation supports an “ Operation Inactivity Timer ”. This timer starts once a C-STORE request has been issued and stops once a C-STORE confirmation has been received. This Timer is set to 60 minutes.

If any of the 2 timers expires, the connection is closed and the operation is considered as failed.

**2-2-1-2-2 Real-World Activity ”Get Worklist”**

**2-2-1-2-2-1 Associated Real-World Activity**

The Worklist option has to be enabled by the system installation procedure.

The operator selects a destination host through a service menu.

The worklist transfer can be initiated from the Patient Viewer Dialogue by pressing the “Worklist” soft key.

This operation will cause:

- the dlx\_root AE to initiate a DICOM association.
- the dlx\_root AE to emit a C-ECHO request to check if the remote AE is available. Finally the association is closed.
- the DLX to build a Basic Worklist C-FIND Request.
- the dlx\_root AE to initiate a DICOM association, select the appropriate Abstract and Transfer Syntax from those accepted by the remote AE.
- the dlx\_root AE to emit the C-FIND Request.
- the dlx\_root AE to receive C-FIND (Worklist) Response(s).
- the DLX to add new entry items to the local database if they are not existing yet.
- the dlx\_root AE to close the association.

**2-2-1-2-2-2 Proposed Presentation Contexts**

Abstract Syntax		Transfer Syntax		Role	Expanded Negotiation
Name	UID	Name List	UID List		
Modality Worklist Information Model – FIND	1.2.840.10008.5.1.4.31	Implicit VR Little Endian	1.2.840.10008.1.2	SCU	None

**2-2-1-2-2-2-1 SOP Specific Conformance Statement for Worklist SOP Class**

This implementation performs a single C-FIND operation over one association.

If the AE does not receive a C-ECHO confirmation, this implementation will terminate the association. The Worklist request is considered as failed.

Upon receiving a C-ECHO confirmation containing an Error, Refused or Warning status, this implementation will consider the result OK. This is because the only purpose of the C-ECHO is to check that the remote AE responds.

Each C-ECHO and C-FIND operation supports an “Association Timer”. This timer starts when the association request is sent and the stops when the association is established. This timer is set to 30 seconds.

The C-ECHO operation supports an “Operation Inactivity Timer”. This timer starts when the C-ECHO request is sent and it stops when the C-ECHO response is received. This timer is also set to 30 seconds.

Upon receiving a C-FIND response containing an error status this implementation will terminate the association issuing a close request. The current C-FIND is considered as failed.

Each C-FIND operation supports an “Operation Inactivity Timer”. This timer starts when the C-FIND request is sent and it stops when the C-FIND final response received. This timer is set to 60 seconds.

If any of the timers expires, the connection is closed and the operation is considered as failed.

Badly formatted C-FIND response(s) from the SCP will result in the initiation of a C-FIND cancel request. In the dlx\_root AE, the C-FIND cancel operation is not implemented as an additional operator choice.

On completion of operation the dlx\_root AE places the status (flag) of the final Worklist update operation on DLX into the Abort flag of the close association request. That way the Worklist provider can get a final success feed back of the complete HIS/RIS data transfer operation. This flag setting doesn't change the basic DICOM association management functionality.

**2-2-1-2-3 Real-world Activity “Verification”**

**2-2-1-2-3-1 Associated Real-World Activity**

The operator selects a destination by selecting an host in the TRANSFER menu (by default the last selected host is active).

Then he presses on the “host verification” button or on the “worklist verification” button if he wants to test the worklist server.

These operations will cause

- the dlx\_root AE to initiate a DICOM association.
- the dlx\_root AE to emit a C-ECHO command to check if the remote AE is available.

**2-2-1-2-3-2 Proposed Presentation contexts**

Presentation Context Table – Proposed					
Abstract Syntax		Transfer Syntax		Role	Expanded Negotiation
Name	UID	Name List	UID List		
Verification	1.2.840.10008.1.1	Implicit VR Little Endian	1.2.840.10008.1.2	SCU	None

**2-2-1-3 Association Acceptance Policy**

The dlx\_root AE provides only DICOM Verification Service Class.

**2-2-1-3-1 Real-World Activity "Verification acknowledge"**

DLX echoes to a Verification request from any DICOM node. This function is transparent to the user (no user interface, no message logged on screen).

**2-2-1-3-1-1 Associated Real-World Activity**

**2-2-1-3-1-2 Accepted Presentation Contexts**

Presentation Context Table – Accepted					
Abstract Syntax		Transfer Syntax		Role	Expanded Negotiation
Name	UID	Name List	UID List		
Verification	1.2.840.10008.1.1	Implicit VR Little Endian	1.2.840.10008.1.2	SCP	None

**2-2-1-3-1-2-1 SOP Specific Conformance Statement for Verification SOP Class**

The dlx\_root AE provides standard conformance to the DICOM Verification Service Class.

**2-3 COMMUNICATION PROFILES****2-3-1 Supported Communication Stacks (parts 8,9)**

DICOM Upper Layer (Part 8) is supported using TCP/IP.

**2-3-2 TCP/IP Stack**

The TCP/IP stack is inherited from a UNIX Operating System.

**2-3-2-1 API**

Not applicable to this product.

**2-3-2-2 Physical Media Support**

Ethernet v2.0, IEEE 802.3.

**2-3-3 Point-to-Point Stack**

A 50-pin ACR-NEMA connection is not applicable to this product.

**2-4 EXTENSIONS / SPECIALIZATIONS / PRIVATIZATIONS**

Refer to Section 3 for the description of AdvantX DLX Private DICOM Data Dictionary

Refer to Section 4 for the description of Secondary capture Private DICOM Data Dictionary

**2-5 CONFIGURATION****2-5-1 AE Title/Presentation Address Mapping**

The Local AE Title is configurable. This must be configured by a GEMS Field Service Engineer during an installation.

**2-5-2 Configurable Parameters**

The following fields are configurable for this AE (local):

- Local AE Title
- Local IP Address

The following fields are configurable for every remote DICOM AE:

- Remote AE Title
- Responding TCP/IP Port
- Remote IP Address

**Note:** All configuration must be performed by a GE Field Engineer.

**2-6 SUPPORT OF EXTENDED CHARACTER SETS**

This implementation supports the following extended character set:  
ISO-IR-100

## SECTION 3 – XA INFORMATION OBJECT IMPLEMENTATION

### 3-0 INTRODUCTION

This section specifies the use of the DICOM v3.0 XRAY Angiographic Image IOD to represent the information included in XRAY Angiographic images produced by this implementation. Corresponding attributes are conveyed using the module construct.

### 3-1 XA IMAGE IOD IMPLEMENTATION

This section defines the implementation of XA image information object. It refers to the DICOM V3.0 Standard, Supplement 4 (Oct 21, 1995) to Part 3 (Information Object definition).

### 3-2 XA IMAGE IOD ENTITY-RELATIONSHIP MODEL

Illustration 3-1  
XRAY Angiographic Image Entity Relationship Diagram

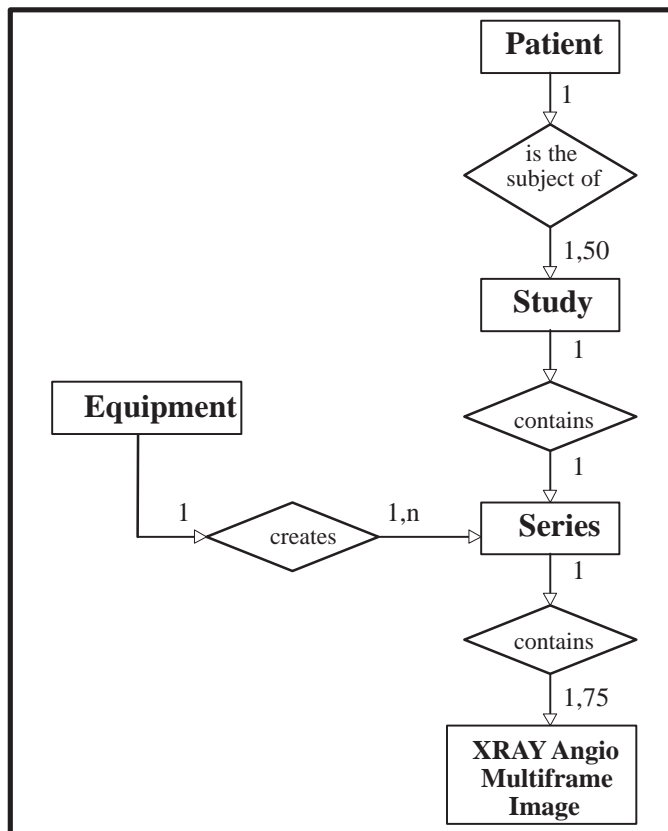

The Entity-Relationship diagram for the XRAY Angiographic Image interoperability schema is shown in Illustration 3-1. In this figure, the following diagrammatic convention is established to represent the information organisation :

- each entity is represented by a rectangular box
- each relationship is represented by a diamond shaped box.
- the fact that a relationship exists between two entities is depicted by lines connecting the corresponding entity boxes to the relationship boxes.

The relationships are fully defined with the maximum number of possible entities in the relationship shown.

**3-2-1 Entities Description**

Refer to DICOM Standard Supplement 4 (Oct 21, 1995) to Part 3 (Information Object Definitions) for a description of the entities contained within this Information object.

**3-2-2 DLX Mapping of DICOM entities**

DICOM entities map to the DLX entities in respect to the following :

DICOM	DLX
Patient Entity	Patient Entity
Study Entity	Examination Entity
Series Entity	no match, there is a one to one relationship between DICOM Study and Series
Multiframe Image Entity	Sequence Entity
Frame	Image

**3-3 XA IMAGE IOD MODULE TABLE**

Within an entity of the DICOM v3.0 XRAY Angio Image Information Object Definition, attributes are grouped into related set of attributes. A set of related attributes is termed a module. A module facilitates the understanding of the semantics concerning the attributes and how the attributes are related with each other. A module grouping does not infer any encoding of information into datasets.

Table 2 identifies the defined modules within the entities which comprise the DICOM v3.0 XRAY Angio Image Information object Definition. Modules are identified by Module Name.

See DICOM v3.0 Part 3 for a complete definition of the entities, modules, and attributes.

**Table 2**  
**XRAY Angiographic Image Information Object Definition (IOD) Module Table**

IE	Module Name	Reference
Patient	Patient	3.4.1.1
Study	General Study	3.4.2.1
	Patient Study	3.4.2.2
Series	General Series	3.4.3.1
	General Equipment	3.4.4.1
Image	General Image	3.4.5.1
	Image Pixel	3.4.5.2
	Cine	3.4.5.3
	Multi–Frame	3.4.5.4
	Frame Pointers	3.4.5.5
	Mask	3.4.5.6
	Display Shutter	3.4.5.7
	Device	3.4.5.8
	X–Ray Image	3.4.5.9
	X–Ray Acquisition	3.4.5.10
	X–Ray Collimator	3.4.5.11
	X–Ray Table	3.4.5.12
	XA Positioner	3.4.5.13
	Curve	3.4.5.14
	SOP Common	3.4.5.15

**3–4 INFORMATION MODULE DEFINITIONS**

Please refer to DICOM v3.0 Standard Part 3 (Information Object Definition) for a description of each of the entities and modules contained within the XRAY Angiographic Information Object.

Modules contain also **type 3 Private elements**.

**3–4–1 Patient Entity Module**

**3–4–1–1 Patient Module**

Attribute Name	Element Tag	TP	Notes
Patient’s Name	0010, 0010	2	From user interface, restricted to 48 char.
Patient ID	0010, 0020	2	From user interface, restricted to 64 char.
Patient’s Birth Date	0010, 0030	2	From user interface, no value if wrong format
Patient’s Sex	0010, 0040	2	From user interface, "M", "F" or "O"
Patient DOB	0011, xx01	3	Patient Date of Birth in free form.

**3-4-2 Study Entity Module****3-4-2-1 General Study**

Attribute Name	Element Tag	TP	Notes
Study Instance UID	0020, 000D	1	Restricted to 64 char.
Study Date	0008, 0020	2	YYYYMMDD, restricted to 8 char.
Study Time	0008, 0030	2	HHMMSS.XXX, restricted to 10 char.
Referring Physicians' Name	0008, 0090	2	From user interface, restricted to 48 char.
Study ID	0020, 0010	2	From user interface, restricted to 64 char.
Accession number	0008, 0050	2	May have a value if coming from worklist already filled, restricted to 16 char.
Study Description	0008, 1030	3	From user interface, restricted to 16 char.

**3-4-2-2 Patient Study**

Attribute Name	Element Tag	TP	Notes
Patient's Size	0010, 1020	3	From user interface.
Patient's Weight	0010, 1030	3	From user interface, restricted to 16 char.
Additional Patient's History	0010, 21B0	3	From user interface, restricted to 252 char.
Patient address	0010, 1040	3	From user interface, restricted to 252 char.
Patient telephone	0010, 2154	3	From user interface, restricted to 32 char.

**3-4-3 Series Entity Module****3-4-3-1 General Series**

Attribute Name	Element Tag	TP	Notes
Modality	0008, 0060	1	XA
Series Instance UID	0020, 000E	1	Restricted to 64 char. Study instance UID + '.1'
Series Number	0020, 0011	2	1
Series Date	0008, 0021	3	YYYYMMDD, restricted to 8 char.
Series Time	0008, 0031	3	HHMMSS.XXX, restricted to 10 char.
Performing Physician's Name	0008, 1050	3	From user interface, restricted to 48 char.
Series Description	0008, 103E	3	From user interface, restricted to 16 char.
Operators' Name	0008, 1070	3	From user interface, restricted to 48 char.



**3-4-4 Equipment Entity Module**

**3-4-4-1 General Equipment**

Attribute Name	Element Tag	TP	Notes
Manufacturer	0008, 0070	3	GE MEDICAL SYSTEMS
Institution Name	0008, 0080	3	Generated by DLXINSTAL during acquisition
Institution Address	0008, 0081	3	
Manufacturer Model Name	0008, 1090	3	DLX
Device Serial Number	0018, 1000	3	Identifier entered in DLXINSTAL
Software versions	0018, 1020	3	Database version, internal to DLX

**3-4-5 Image Entity Module**

**3-4-5-1 General Image**

Attribute Name	Element Tag	TP	Notes
Image Number	0020,0013	2	Image number in the Series
Image Date	0008,0023	2C	YYYYMMDD, restricted to 8 char.
Image Time	0008,0033	2C	HHMMSS.XXX, restricted to 10 char.
Image Type	0008,0008	3	ORIGINAL\PRIMARY\ either SINGLE PLANE, BIPLANE A or BIPLANE B
Acquisition Date	0008,0022	3	YYYYMMDD, restricted to 8 char.
Acquisition Time	0008,0032	3	HHMMSS.XXX, restricted to 10 char.
Patient Orientation	0020,0020	2	No value, Zero length
Image comments	0020,4000	3	From user interface, restricted to 16 char.
Referenced Image Sequence	0008, 1140	3	In case of DLX biplane acquisition, used to identify the related plane Image (LATeral if FRonTal or FRonTal if LATeral)
>Referenced SOP Class UID	0008, 1150	1C	1.2.840.10008.5.1.4.1.1.12.1
>Referenced SOP Instance UID	0008, 1155	1C	Restricted to 64 char. Series_UID if monoplane, Series_UID + '.1' if frontal from biplane, Series_UID + '.2' if lateral from biplane
Lossy Image Compression	0028, 2110	3	00
Side_mark	0019, xx1D	3	represents patient orientation as 2 characters located on the left and right side of the displayed frame. Encoding is the following : 0 : not defined 1, 4, 6 : Left of the patient is on the left side of the frame 2, 3, 5 : Right of the patient is on the left side of the frame

**3-4-5-2 Image Pixel**

Attribute Name	Element Tag	TP	Notes
Samples per Pixel	0028, 0002	1	1
Photometric Interpretation	0028, 0004	1	MONOCHROME1 if reverse video, or MONOCHROME2 otherwise
Rows	0028, 0010	1	512 or 1024
Columns	0028, 0011	1	512 or 1024
Bits Allocated	0028, 0100	1	8 or 16
Bits Stored	0028, 0101	1	8 or 10
High Bit	0028, 0102	1	7 or 9
Pixel Representation	0028, 0103	1	0
Pixel Data	7FE0, 0010	1	

**3-4-5-3 Cine**

Attribute Name	Element Tag	TP	Notes
Frame Time Vector	0018, 1065	1C	Generated by acquisition system
Start Trim	0008, 2142	1	Generated by acquisition system
Stop Trim	0008, 2143	1	Generated by acquisition system
Recommended Display Frame Rate	0008, 2144	1	Generated by acquisition system
Frame Delay	0018, 1066	1	0.0
Cine Rate	0018, 0040	1	Generated by acquisition system

**3-4-5-4 Multi-Frame**

Attribute Name	Element Tag	TP	Notes
Number of Frames	0028, 0008	1	Generated by acquisition system
Frame Increment pointer	0028, 0009	1	0018, 1065

**3-4-5-5 Frame Pointers**

Attribute Name	Element Tag	TP	Notes
Representative Frame Number	0028, 6010	3	Initialized as the frame number located at the 1/3rd of the multiframe image.
Cur_spatial_filter_strength	0019, xx17	3	
Zoom_factor	0019, xx18	3	1, 2 or 4
X_zoom	0019, xx19	3	coordinate of the center of the zoomed area
Y_zoom	0019, xx1A	3	coordinate of the center of the zoomed area
Text_annotation	70nn, xx04	3	There could be up to 5 annotation per images
Box	70nn, xx05	3	Coordinates of the lower left corner of the first character of the annotation (x, y)
Arrow end	70nn, xx07	3	Coordinates of extremities of the arrow (x, y), the arrow always starts from the annotation text. Arrows is always a straight line. (0,0) value means 'no arrow' is attached to the annotation.

**3-4-5-6 Mask**

Attribute Name	Element Tag	TP	Notes
Mask Subtraction Sequence	0028, 6100	1	
>Mask Operation	0028, 6101	1	NONE or AVG_SUB
>Applicable Frame Range	0028, 6102	3	generated by acquisition system
>Mask Frame Numbers	0028, 6110	1C	Number of mask image: from user interface or generated by acquisition system (depending on acquisition mode)
>Mask Sub-pixel shift	0028, 6114	3	Xpixel shift / Ypixel shift: from user interface
Recommended viewing mode	0028, 1090	2	SUB/NAT
Percentage_landscape	0019, xx1E	3	Percentage of mask applied

**3-4-5-7 Display Shutter**

Attribute Name	Element Tag	TP	Notes
Shutter Shape	0018, 1600	1	CIRCULAR or RECTANGULAR. Combined Rectangular and Circular could exist and is represented by both RECTANGULAR/CIRCULAR attributes.
Display Shutter Left Vertical Edge	0018, 1602	1C	From user interface
Display Shutter Right Vertical Edge	0018, 1604	1C	From user interface
Display Shutter Upper Horizontal Edge	0018, 1606	1C	From user interface
Display Shutter Lower Horizontal Edge	0018, 1608	1C	From user interface
Center of Circular Display Shutter	0018, 1610	1C	From user interface
Radius of Circular Display Shutter	0018, 1612	1C	From user interface

**3-4-5-8 Device**

Attribute Name	Element Tag	TP	Notes
Device Sequence	0050, 0010	3	
>Code Value	0008, 0100	1C	BALL or CATHETER
>Coding Scheme Designator	0008, 0102	1C	99DEV
>Device Diameter	0050, 0016	3	Set in DLXINSTAL for BALL, from user interface for CATHETER
>Device Diameter Units	0050, 0017	2C	MM

## 3-4-5-9 X-Ray Image

Attribute Name	Element Tag	TP	Notes
Frame Increment pointer	0028, 0009	1C	
Lossy Image Compression	0028,2110	1C	00
Image Type	0008, 0008	1	ORIGINAL\PRIMARY\ either SINGLE PLANE, BIPLANE A or BIPLANE B
Pixel Intensity Relationship	0028, 1040	1	value : LIN, or DISP. In DISP mode, only spatial measurements are available.
Samples per Pixel	0028,0002	1	1
Photometric interpretation	0028,0004	1	MONOCHROME1 if reverse video, MONOCHROME2 otherwise
Bits allocated	0028, 0100	1	8 or 16
Bits stored	0028, 0101	1	8 or 10
High Bit	0028, 0102	1	7 or 9
Pixel Representation	0028, 0103	1	0
Reference Image Sequence	0008, 1140	1C	Used to identify the related plane Image in case of Biplane acquisition (LATeral if FRonTal or FRonTal if LATeral)
>Reference SOP class UID	0008, 1150	1C	1.2.840.10008.5.1.4.1.1.12.1
>Reference SOP instance UID	0008, 1155	1C	Restricted to 64 char. Series_UID if monoplane, Series_UID + '.2' if frontal from biplane, Series_UID + '.1' if lateral from biplane
R Wave Pointer	0028, 6040	3	
Scan Options	0018, 0022	3	EKG or STEP, or CHASE, or ROTA or no value
Calibration Image	0050, 0004	3	No value, zero length

## 3-4-5-10 X-Ray Acquisition

Attribute Name	Element Tag	TP	Notes
KVP	0018, 0060	2	Generated by acquisition system
Field of view Shape	0018, 1147	3	ROUND
Field of View Dimension	0018, 1149	3	Generated by acquisition system, multiplied by 25.4
Grid	0018, 1166	3	IN
Radiation Mode	0018, 115A	3	PULSED
Radiation Setting	0018, 1155	1	GR
Exposure Time	0018, 1150	2C	Generated by acquisition system
X-ray Tube Current	0018, 1151	2C	Restricted to 8 char.
Intensifier Size	0018,1162	3	Set in DLXINSTAL, multiplied by 25.4
Adx_procedure_name	0019, xx07	3	free text information
Adx_exam_name	0019, xx08	3	free text information
Adx_patient_size	0019, xx09	3	LOW, MEDIUM, ADULT
Acq_Record View	0019, 000A	3	1 Frontal, 2 Lateral 3 Biplane
Adx_injector_delay	0019, xx10	3	delay in start of injection in 1/10th of seconds
Adx_auto_inject	0019, xx11	3	1 if autoinjection, 0 if not
Adx_acq_mode	0019, xx14	3	0,1 for vascular 2..7 for cardiac 8..13 for DSA stepping 14..19, 26 for Bolus Chasing 20..25 for HSS acquisition

Attribute Name	Element Tag	TP	Notes																																		
Adx_camera_rotation_enable	0019, xx15	3	0 → disable 1 → enable Value sent by acquisition system Advantx-E 0 if generated by acquisition system Advantx I																																		
Adx_reverse_sweep	0019, xx16	3	<table border="1"> <thead> <tr> <th>Value</th> <th>Meaning</th> </tr> </thead> <tbody> <tr><td>0</td><td>No reverse sweep on frontal and lateral</td></tr> <tr><td>1</td><td>No reverse sweep on lateral, only vertical reverse sweep on frontal,</td></tr> <tr><td>2</td><td>No reverse sweep on lateral, only horizontal reverse sweep on frontal,</td></tr> <tr><td>3</td><td>No reverse sweep on lateral, vertical and horizontal reverse sweep on frontal,</td></tr> <tr><td>4</td><td>Only vertical reverse sweep on lateral, no reverse sweep on frontal,</td></tr> <tr><td>5</td><td>Only vertical reverse sweep on lateral, only vertical reverse sweep on frontal,</td></tr> <tr><td>6</td><td>Only vertical reverse sweep on lateral, only horizontal reverse sweep on frontal,</td></tr> <tr><td>7</td><td>Only vertical reverse sweep on lateral, vertical and horizontal reverse sweep on frontal,</td></tr> <tr><td>8</td><td>Only horizontal reverse sweep on lateral, no reverse sweep on frontal,</td></tr> <tr><td>9</td><td>Only horizontal reverse sweep on lateral, only vertical reverse sweep on frontal,</td></tr> <tr><td>10</td><td>Only horizontal reverse sweep on lateral, only horizontal reverse sweep on frontal,</td></tr> <tr><td>11</td><td>Only horizontal reverse sweep on lateral, vertical and horizontal reverse sweep on frontal,</td></tr> <tr><td>12</td><td>Vertical and horizontal reverse sweep on lateral, no reverse sweep on frontal,</td></tr> <tr><td>13</td><td>Vertical and horizontal reverse sweep on lateral, only vertical reverse sweep on frontal,</td></tr> <tr><td>14</td><td>Vertical and horizontal reverse sweep on lateral, only horizontal reverse sweep on frontal,</td></tr> <tr><td>15</td><td>Vertical and horizontal reverse sweep on lateral, vertical and horizontal reverse sweep on frontal.</td></tr> </tbody> </table> Values sent by acquisition system Advantx-E 0 if generated by acquisition system Advantx I	Value	Meaning	0	No reverse sweep on frontal and lateral	1	No reverse sweep on lateral, only vertical reverse sweep on frontal,	2	No reverse sweep on lateral, only horizontal reverse sweep on frontal,	3	No reverse sweep on lateral, vertical and horizontal reverse sweep on frontal,	4	Only vertical reverse sweep on lateral, no reverse sweep on frontal,	5	Only vertical reverse sweep on lateral, only vertical reverse sweep on frontal,	6	Only vertical reverse sweep on lateral, only horizontal reverse sweep on frontal,	7	Only vertical reverse sweep on lateral, vertical and horizontal reverse sweep on frontal,	8	Only horizontal reverse sweep on lateral, no reverse sweep on frontal,	9	Only horizontal reverse sweep on lateral, only vertical reverse sweep on frontal,	10	Only horizontal reverse sweep on lateral, only horizontal reverse sweep on frontal,	11	Only horizontal reverse sweep on lateral, vertical and horizontal reverse sweep on frontal,	12	Vertical and horizontal reverse sweep on lateral, no reverse sweep on frontal,	13	Vertical and horizontal reverse sweep on lateral, only vertical reverse sweep on frontal,	14	Vertical and horizontal reverse sweep on lateral, only horizontal reverse sweep on frontal,	15	Vertical and horizontal reverse sweep on lateral, vertical and horizontal reverse sweep on frontal.
Value	Meaning																																				
0	No reverse sweep on frontal and lateral																																				
1	No reverse sweep on lateral, only vertical reverse sweep on frontal,																																				
2	No reverse sweep on lateral, only horizontal reverse sweep on frontal,																																				
3	No reverse sweep on lateral, vertical and horizontal reverse sweep on frontal,																																				
4	Only vertical reverse sweep on lateral, no reverse sweep on frontal,																																				
5	Only vertical reverse sweep on lateral, only vertical reverse sweep on frontal,																																				
6	Only vertical reverse sweep on lateral, only horizontal reverse sweep on frontal,																																				
7	Only vertical reverse sweep on lateral, vertical and horizontal reverse sweep on frontal,																																				
8	Only horizontal reverse sweep on lateral, no reverse sweep on frontal,																																				
9	Only horizontal reverse sweep on lateral, only vertical reverse sweep on frontal,																																				
10	Only horizontal reverse sweep on lateral, only horizontal reverse sweep on frontal,																																				
11	Only horizontal reverse sweep on lateral, vertical and horizontal reverse sweep on frontal,																																				
12	Vertical and horizontal reverse sweep on lateral, no reverse sweep on frontal,																																				
13	Vertical and horizontal reverse sweep on lateral, only vertical reverse sweep on frontal,																																				
14	Vertical and horizontal reverse sweep on lateral, only horizontal reverse sweep on frontal,																																				
15	Vertical and horizontal reverse sweep on lateral, vertical and horizontal reverse sweep on frontal.																																				
Adx_focus	0019, xx1B	3	focus on frontal plane																																		
Adx_dose	0019, xx1C	3	0, 1, 2, 3 for dose A, B, C, D																																		
Adx_exposure_duration	0019, xx1F	3	in ms.																																		
IP address	0019, xx20	3	IP Address of the machine that sends the serie																																		

**3-4-5-11 X-Ray Collimator**

Attribute Name	Element Tag	TP	Notes
Collimator shape	0018,1700	1	value : CIRCULAR
Center of circular collimator	0018,1710	1C	512\512 or 256\256
Radius of circular Collimator	0018,1712	1C	Set in DLXINSTAL

**3-4-5-12 XA Positioner**

Attribute Name	Element Tag	TP	Notes
Distance Source to Patient	0018, 1111	3	Value sent by acquisition system Advantx-E 0 if generated by acquisition system Advantx1
Distance Source to detector	0018, 1110	3	Value sent by acquisition system Advantx-E 0 if generated by acquisition system Advantx1
Estimated Radiographic Magnification factor	0018, 1114	3	(0018, 1110) divided by (0018, 1111)
Positioner Motion	0018, 1500	2C	STATIC or DYNAMIC
Positioner Primary Angle	0018, 1510	2	Calculated with (0019, 0006), (0019, 0001), (0019, 0002), (0019, 0003)
Positioner Secondary Angle	0018, 1511	2	Calculated with (0019, 0006), (0019, 0001), (0019, 0002), (0019, 0003)
Positioner Primary Angle Increment	0018, 1520	2C	Generated by acquisition system
Positioner Secondary Angle Increment	0018, 1521	2C	Generated by acquisition system
Angle_value_1	0019, xx01	3	Positioner angle for L arm in degrees
Angle_value_2	0019, xx02	3	Positioner angle for P arm in degrees
Angle_value_3	0019, xx03	3	Positioner angle for C arm in degrees
Angle_label_1	0019, xx04	3	L
Angle_label_2	0019, xx05	3	CAU, CRA
Angle_label_3	0019, xx06	3	LAO, RAO

**3-4-5-13 X-Ray table**

Attribute Name	Element Tag	TP	Notes
Table Motion	0018, 1134	2	DYNAMIC or STATIC
Table Vertical Increment	0018, 1135	2C	0
Table Longitudinal Increment	0018, 1137	2C	Generated by acquisition system
Table Lateral Increment	0018, 1136	2C	0
Table Vertical position	0019, xx21	3	Vertical position of table in mm with respect to GEMS defined origin.
Table Longitudinal position	0019, xx22	3	Longitudinal position of table in mm with respect to GEMS defined origin.
Table Lateral position	0019, xx23	3	Vertical position of table in mm with respect to GEMS defined origin.

**3-4-5-14 Curve**

Attribute Name	Element Tag	TP	Notes
Curve Dimensions	50xx, 0005	1	1 for PHYSIO, 2 for ROI
Number of points	50xx, 0010	1	Generated by acquisition system for PHYSIO, from user interface for ROI
Type of Data	50xx, 0020	1	ROI or PHYSIO
Data Value Representation	50xx, 0103	1	0
Curve Data	50xx, 3000	1	
Curve Description	50xx, 0022	3	only if Type of Data (50xx, 0020) = ROI, then DIASTOLE or SYSTOLE

Curves can be either Cardiac Contours (1 diastolic and 1 systolic per multiframe image), or a physiological curve (e.g. EKG). For a Multiframe Image, there could be 2 Cardiac contour and 2 physiological curves.

**3-4-5-15 SOP Common**

Attribute Name	Element Tag	TP	Notes
SOP Class UID	0008, 0016	1	1.2.840.10008.5.1.4.1.1.12.1
SOP Instance UID	0008, 0018	1	Restricted to 64 char. Series_UID if monoplane, Series_UID + '.1' if frontal from biplane, Series_UID + '.2' if lateral from biplane
Specific Character	0008, 0005	1C	ISO-IR-100

## PRIVATE DATA DICTIONARY

Attribute Name	Data Element Tag	VR	VM
<b>Private Creator PATIENT_01</b>	<b>0011, 00xx</b>	<b>LO</b>	<b>1</b>
Patient DOB	0011, xx01	LT	1
<b>Private Creator Series_01</b>	<b>0019, 00xx</b>	<b>LO</b>	<b>1</b>
Angle_value_1	0019, xx01	DS	1
Angle_value_2	0019, xx02	DS	1
Angle_value_3	0019, xx03	DS	1
Angle_label_1	0019, xx04	CS	1
Angle_label_2	0019, xx05	CS	1
Angle_label_3	0019, xx06	CS	1
Adx_procedure_name	0019, xx07	ST	1
Adx_exam_name	0019, xx08	ST	1
Adx_patient_size	0019, xx09	SH	1
Acq_record view	0019, 000A	IS	1
Adx_injector_delay	0019, xx10	DS	1
Adx_auto_inject	0019, xx11	CS	1
Adx_acq_mod	0019, xx14	IS	1
Adx_camera_rotation_enable	0019, xx15	CS	1
Adx_reverse_sweep	0019, xx16	CS	1
Cur_spatial_filter_strength	0019, xx17	IS	1
Zoom_factor	0019, xx18	IS	1
X_zoom	0019, xx19	IS	1
Y_zoom	0019, xx1A	IS	1
Adx_focus	0019, xx1B	DS	1
Adx_dose	0019, xx1C	CS	1
Side_mark	0019, xx1D	IS	1
Percentage_landscape	0019, xx1E	IS	1
Adx_exposure_duration	0019, xx1F	DS	1
IP address	0019, xx20	SH	1
Table vertical position	0019, xx21	*	*
Table longitudinal position	0019, xx22	*	*
Table lateral position	0019, xx23	*	*
<b>Private Creator ANNOT_01</b>	<b>70nn, 00xx</b>	<b>LO</b>	<b>1</b>
Text_annotation	70nn, xx04	ST	1
Box	70nn, xx05	IS	2
Arrow end	70nn, xx07	IS	2

\*: to be defined by person who implements.



<b>Attribute Name</b>	<b>Data Element Tag</b>	<b>Value</b>
Private Creator PATIENT_01	0011,00xx	DLX_PATNT_01
Private Creator SERIE_01	0019,00xx	DLX_SERIE_01
Private Creator ANNOT_01	70nn,00xx	DLX_ANNOT_01

Blank page

## **SECTION 4 – SECONDARY CAPTURE IMPLEMENTATION**

### **4–0 INTRODUCTION**

This section specifies the use of the DICOM v3.0 Secondary Capture Image IOD to represent the information included in Secondary Capture images produced by this implementation. Corresponding attributes are conveyed using the module construct.

### **4–1 SC IMAGE IOD IMPLEMENTATION**

This section defines the implementation of SC image information object. It refers to the DICOM V3.0 Standard, Part 3 (Information Object definition).

### **4–2 SC IMAGE IOD ENTITY–RELATIONSHIP MODEL**

**Illustration 4-1**  
**SC Image Entity Relationship Diagram**

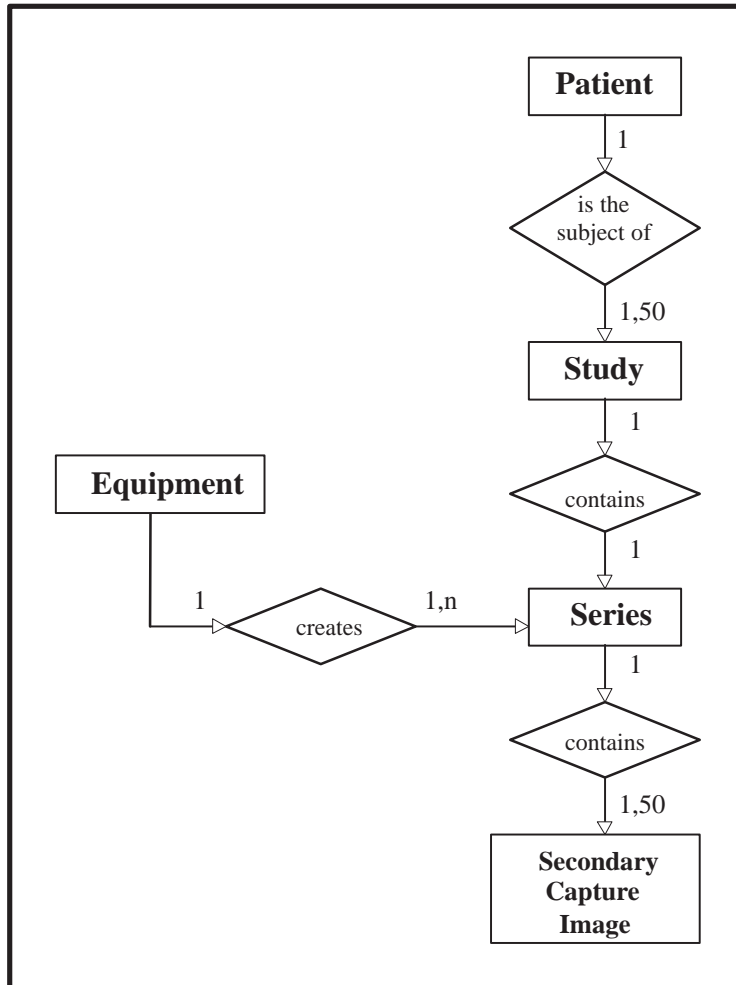

The Entity-Relationship diagram for the SC Image interoperability schema is shown in Illustration 4-1. The following diagrammatic convention is established to represent the information organisation :

- each entity is represented by a rectangular box
- each relationship is represented by a diamond shaped box
- the fact that a relationship exists between two entities is depicted by lines connecting the corresponding entity boxes to the relationship boxes.

The relationships are fully defined with the maximum number of possible entities in the relationship shown.

**4-2-1 Entities Description**

Refer to DICOM Standard Part 3 (Information Object Definitions) for a description of each of the entities contained within the Secondary Capture Image Information Object Definition.

**4-2-2 DLX Mapping of DICOM entities**

DICOM entities map to the DLX entities in respect to the following :

DICOM	DLX
Patient Entity	Patient Entity
Study Entity	Examination Entity
Serie Entity	no match, there is a one to one relationship between DICOM Study and Serie
Secondary Image Entity	Photo Entity

**4-3 SC IMAGE IOD MODULE TABLE**

Within an entity of the DICOM v3.0 XRAY Angio Image Information Object Definition, attributes are grouped into related set of attributes. A set of related attributes is termed a module. A module facilitates the understanding of the semantics concerning the attributes and how the attributes are related with each other. A module grouping does not infer any encoding of information into datasets.

Table 5-2 identifies the defined modules within the entities which comprise the DICOM v3.0 XRAY Angio Image Information object Definition. Modules are identified by Module Name.

See DICOM v3.0 Part 3 for a complete definition of the entities, modules, and attributes.

**Table 4.2  
SC Image Information Object Definition (IOD) Module Table**

IE	Module Name	Reference
Patient	Patient	4-4-1-1
Study	General Study	4-4-2-1
	Patient Study	4-4-2-2
Series	General Series	4-4-3-1
	SC Equipment	4-4-4-1
Equipment	General Image	4-4-5-1
	Image Pixel	4-4-5-2
Image	Overlay Plane	4-4-5-3
	SOP Common	4-4-5-4

**4-4 MODULE LIBRARY**

Please refer to DICOM v3.0 Standard Part 3 (Information Object Definition) for a description of each of the entities and modules contained within the SC Information Object.

Modules contain also **type 3 Private elements**.

See DICOM v3.0 Part 3 for a complete definition of the entities, modules, and attributes.

**4-4-1 Patient Entity Module****4-4-1-1 Patient Module**

Attribute Name	Element Tag	TP	Notes
Patient's Name	0010, 0010	2	From user interface, restricted to 48 char.
Patient ID	0010, 0020	2	From user interface, restricted to 64 char.
Patient's Birth Date	0010, 0030	2	From user interface, no value if wrong format
Patient's Sex	0010, 0040	2	From user interface, "M", "F" or "O"
Patient DOB	0011, xx01	3	Patient Date of birth in free form.

**4-4-2 Study Entity Module****4-4-2-1 General Study**

Attribute Name	Element Tag	TP	Notes
Study Instance UID	0020, 000D	1	Restricted to 64 char.
Study Date	0008, 0020	2	YYYYMMDD, restricted to 8 char.
Study Time	0008, 0030	2	HHMMSS.XXX, restricted to 10 char.
Referring Physicians' Name	0008, 0090	2	From user interface, restricted to 48 char.
Study ID	0020, 0010	2	From user interface, restricted to 64 char.
Accession number	0008, 0050	2	May have a value if coming from worklist already filled, restricted to 16 char.
Study Description	0008, 1030	3	From user interface, restricted to 16 char.

**4-4-2-2 Patient Study**

Attribute Name	Element Tag	TP	Notes
Patient's Size	0010, 1020	3	From user interface.
Patient's Weight	0010, 1030	3	From user interface, restricted to 16 char.
Additional Patient's History	0010, 21B0	3	From user interface, restricted to 252 char.
Patient address	0010, 1040	3	From user interface, restricted to 252 char.
Patient telephone	0010, 2154	3	From user interface, restricted to 32 char.

**4-4-3 Series Entity Module****4-4-3-1 General Series**

Attribute Name	Element Tag	TP	Notes
Modality	0008, 0060	1	value : XA
Series Instance UID	0020, 000E	1	Restricted to 64 char. Study instance UID + '.1'
Series Number	0020, 0011	2	value : 1
Series Date	0008, 0021	3	YYYYMMDD, restricted to 8 char.
Series Time	0008, 0031	3	HHMMSS.XXX, restricted to 10 char.
Performing Physician's Name	0008, 1050	3	From user interface, restricted to 48 char.
Series Description	0008, 103E	3	From user interface, restricted to 16 char.
Operators' Name	0008, 1070	3	From user interface, restricted to 48 char.
Patient position	0018, 5100	2C	No value, Zero length

4-4-4 Equipment Entity Module

4-4-4-1 SC Equipment Module

Attribute Name	Element Tag	TP	Notes
Conversion Type	0008,0064	1	WSD
Modality	0008,0060	3	XA
Manufacturer	0008,0070	3	GE MEDICAL SYSTEMS
Institution name	0008,0080	3	Generated by DLXINSTAL during acquisition
Institution Address	0008,0081	3	
Secondary Capture Device Manufacturer	0018,1016	3	GE MEDICAL SYSTEMS
Secondary Capture Device Manufacturer's Model Name	0018,1018	3	DLX

4-4-5 Image Entity Module

4-4-5-1 General Image

Attribute Name	Element Tag	TP	Notes
Image Number	0020,0013	2	Image number in the serie
Image Date	0008,0023	2C	YYYYMMDD, restricted to 8 char.
Image Time	0008,0033	2C	HHMMSS.XXX, restricted to 10 char.
Image Type	0008,0008	3	DERIVED\SECONDARY\ either SINGLE PLANE, BIPLANE A or BIPLANE B
Patient Orientation	0020,0020	2C	No value, Zero length
Referenced Image Sequence	0008,1140	3	Used to reference the associated plane Secondary Capture in case of Biplane Acquisition
>Referenced SOP Class UID	0008,1150	1C	1.2.840.10008.5.1.4.1.1.7
>Referenced SOP Instance UID	0008,1155	1C	Restricted to 64 char. Photo_UID + '.2' if frontal plane photo, Photo_UID + '.1' if lateral plane photo
Source Image Sequence	0008,2112	3	used to reference the original acquisition
>Referenced SOP Class UID	0008,1150	1C	1.2.840.10008.5.1.4.1.1.12.1
>Referenced SOP Instance UID	0008,1155	1C	Restricted to 64 char. Series_UID + '.1' if frontal plane photo, Series_UID + '.2' if lateral plane photo
Image comments	0020,4000	3	From user interface, restricted to 16 char.

## 4-4-5-2 Image Pixel

Attribute Name	Element Tag	TP	Notes
Samples per Pixel	0028, 0002	1	1
Photometric Interpretation	0028, 0004	1	MONOCHROME1 if reverse video, or MONOCHROME2 otherwise
Rows	0028, 0010	1	512 or 1024
Columns	0028, 0011	1	512 or 1024
Bits Allocated	0028, 0100	1	16
Bits Stored	0028, 0101	1	8
High Bit	0028, 0102	1	7
Pixel Representation	0028, 0103	1	0
Pixel Data	7FE0, 0010	1	

## 4-4-5-3 Overlay Plane Module

Attribute Name	Element Tag	TP	Notes
Rows	60nn, 0010	1	512 or 1024
Columns	60nn, 0011	1	512 or 1024
Overlay type	60nn, 0040	1	G
Origin	60nn, 0050	2	1,1
Bits Allocated	60nn, 0100	1	1
Bit Position	60nn, 0102	1	8..15
Gray Palette color lookup table descriptor	60nn, xx01	3	'1,1,8', to describe a lookup table of 1 entry, with the ovl value mapped on the 1rst entry of the lookup table, and with lookup table data coded on 8 bits (0.255). For complete description, refer to Palette color lookup table descriptor of Image pixel module (tag 0028,1101)
Gray Palette color lookup table data	60nn, xx02	3	0 for black overlay 255 for white overlay For complete description, refer to Palette color lookup table data of Image pixel module (tag 0028,1201)

## 4-4-5-4 SOP Common

Attribute Name	Element Tag	TP	Notes
SOP Class UID	0008, 0016	1	1.2.840.10008.5.1.4.1.1.7
SOP Instance UID	0008, 0018	1	Restricted to 64 char. Series_UID + '.1' if frontal plane photo, Series_UID + '.2' if lateral plane photo
Specific Character Set	0008, 0005	1C	ISO-IR-100



4-5

**PRIVATE DATA DICTIONARY FOR SECONDARY CAPTURE**

Attribute Name	Data Element Tag	VR	VM
<b>Private Creator PATIENT_01</b>	<b>0011,00xx</b>	<b>LO</b>	<b>1</b>
Patient DOB	0011, xx01	LT	1
<b>Private Creator LKUP_01</b>	<b>60nn,00xx</b>	<b>LO</b>	<b>1</b>
Gray Palette color lookup table descriptor	60nn, xx01	LT	3
Gray Palette color lookup table data	60nn, xx02	LT	1

Attribute name	Data Element Tag	Value
Private Creator PATIENT_01	0011,00xx	DLX_PATNT_01
Private Creator LKUP_01	60nn,00xx	DLX_LKUP_01

Blank page

## SECTION 5 – BASIC WORKLIST MANAGEMENT IMPLEMENTATION

### 5-0 INTRODUCTION

This section specifies the use of the Basic Worklist Management Information Objects to transfer the Worklist from the Information System to the Application Entity where the task is performed.

### 5-1 WORKLIST INFORMATION MODEL IMPLEMENTATION

This section defines the implementation of the Basic Worklist Information Object. It refers to the DICOM V3.0 Standard, Basic Worklist Management – Supplement 10 (August 11, 1995) to Part 3 (Information Object definition).

### 5-2 WORKLIST INFORMATION MODEL ENTITY – RELATIONSHIP DIAGRAM

ILLUSTRATION 5-1

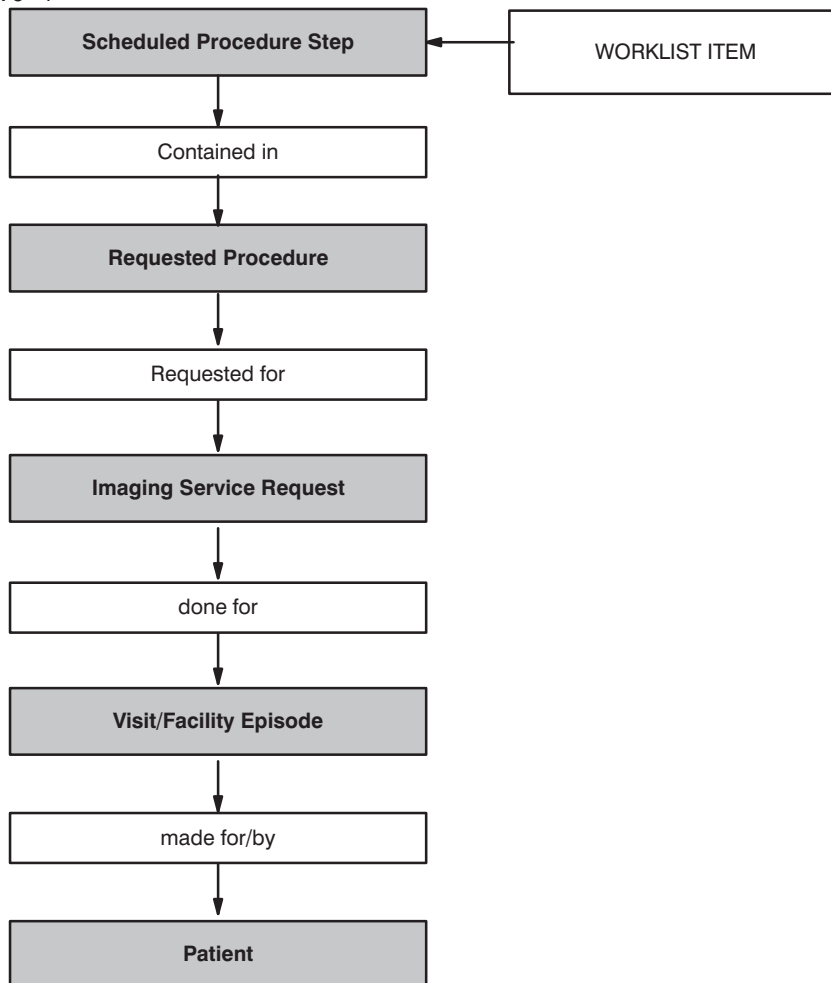

The Entity–Relationship diagram for the Basic Worklist Management interoperability schema is shown in Illustration 5–1. In this figure, the following diagrammatic convention is established to represent the information organization :

- each entity is represented by the gray rectangular box.
- each relationship is represented by the white rectangular box.
- the fact that a relationship exists between the two entities is depicted by lines connecting the corresponding entity boxes to the relationship boxes.

**5–2–1 Entities Description**

Refer to DICOM Standard Supplement 10 (August 11, 1995) to Part 3 (Information Object Definitions) for a description of the entities contained within this Information object.

**5–3 BASIC WORKLIST INFORMATION MODULE TABLE**

Within an entity of the DICOM v3.0 Basic Worklist Information Object Definition, attributes are grouped into related set of attributes. A set of related attributes is termed a module. A module facilitates the understanding of the semantics concerning the attributes and how the attributes are related with each other. A module grouping does not infer any encoding of information into data sets.

Table 2 identifies the defined modules within the entities which comprise the DICOM v3.0 Basic Worklist Management Information Object. Modules are identified by Module Name.

See DICOM v3.0 Part 3 for a complete definition of the entities, modules and attributes.

**Table 2 Basic Worklist Management Information Module Table**

IE	MODULE NAME	Reference
Patient	Patient Identification Module	para. 5–4–1–1
	Patient Demographic Module	para. 5–4–1–2
	Patient Medical Module	para. 5–4–1–3
Visit/Facility Episode	Visit Identification Module	para. 5–4–2–1
	Visit Status Module	para. 5–4–2–2
	Visit Relationship Module	para. 5–4–2–3
Imaging Service Request	Imaging Service Request Module	para. 5–4–3–1
Requested Procedure	Requested Procedure Module	para. 5–4–4–1
Scheduled Procedure Step	Scheduled Procedure Step Module	para. 5–4–5–1
	SOP Common Module	para. 5–4–5–2

**5-4 INFORMATION MODULE DEFINITIONS**

Please refer to DICOM v3.0 Standard Part 3 (Information Object Definition) and the supplements for a description of each of the entities and modules contained within the Basic Worklist Management Information Object.

Modules do not contain any **type 3 Private Elements**.

**5-4-1 Patient Entity Module**

**5-4-1-1 Patient Identification Module**

Attribute Name	Element Tag	Expected matching key type	Expected Returned key type	Mapped into the image	Notes
Patient's Name	0010, 0010	R	1	Yes	Zero length sent. Truncated to 48 characters. Last name is truncated to 25, first name is truncated to 20. A "^" character is added to separate last name and first name in database
Patient ID	0010, 0020	R	1	Yes	Zero length sent. Truncated to 18 characters.

**5-4-1-2 Patient Demographic Module**

Attribute Name	Element Tag	Expected matching key type	Expected Returned key type	Mapped into the image	Notes
Patient's Address	0010, 1040	O	3	Yes	Truncated to 252 characters. Each line is truncated to 30 characters. Add " " after each line, then concatenate them in database.
Patients Telephone Numbers	0010, 2154	O	3	Yes	Truncated to 32 characters.
Patient's Birth Date	0010, 0030	O	2	Yes	Truncated to 24 characters.
Patient's Sex	0010, 0040	O	2	Yes	'0' if "M", '1' otherwise.
Patient's Size	0010, 1020	O	3	Yes	Truncated to 16 characters. Multiplied by 100. (Unit = cm)
Patient's Weight	0010, 1030	O	2	Yes	Truncated to 16 characters.

**5-4-1-3 Patient Medical Module**

Attribute Name	Element Tag	Expected matching key type	Expected Returned key type	Mapped into the image	Notes
Additional Patient History	0010, 21B0	O	3	Yes	Truncated to 252 characters.

**5-4-2 Visit/Facility Episode Entity Module**

**5-4-2-1 Visit Identification Module**

Attribute Name	Element Tag	Expected matching key type	Expected Returned key type	Mapped into the image	Notes
Institution Name	0008, 0080	O	3	Yes	Truncated to 48 characters.
Admission ID	0038, 0010	O	2	No	

**5-4-2-2 Visit Status Module**

This Module is not sent as the necessary information is not available.

**5-4-2-3 Visit Relationship Module**

This Module is not sent as the necessary information is not available.

**5-4-3 Imaging Service Request Entity Module**

**5-4-3-1 Imaging Service Request Module**

Attribute Name	Element Tag	Expected matching key type	Expected Returned key type	Mapped into the image	Notes
Referring Physician's Name	0008, 0090	O	2	Yes	Truncated to 48 characters.
Accession Number	0008, 0050	O	1	Yes	Truncated to 16 characters. '\ ' and control characters are replaced by space character.

**5-4-4 Requested Procedure Entity Module**

**5-4-4-1 Requested Procedure Module**

Attribute Name	Element Tag	Expected matching key type	Expected Returned key type	Mapped into the image	Notes
Requested Procedure ID	0040, 1001	O	1	Yes	Truncated to 64 characters. "0" if empty.
Study Instance UID	0020, 000D	O	1	Yes	Truncated to 64 characters. Affected by database if empty.
Requested Procedure Description	0032, 1060	O	1C	Yes	Truncated to 252 characters.

**5-4-5 Scheduled Procedure Step Entity Module**

**5-4-5-1 Scheduled Procedure Step Module**

Attribute Name	Element Tag	Expected matching key type	Expected Returned key type	Mapped into the image	Notes
Scheduled Procedure Step Sequence	0040, 0100	R	1	No	
>Scheduled Station AE title	0040, 0001	R	1	No	Zero length sent
>Scheduled Station Name	0040, 0010	O	2	No	local station name sent (*)
>Scheduled Procedure Step Start Date	0040, 0002	R	1	No	Zero length sent
>Scheduled Procedure Step Start Time	0040, 0003	R	1	No	Zero length sent
>Scheduled Performing Physician's Name	0040, 0006	R	2	Yes	Truncated to 20 characters.
>Scheduled Procedure Step ID	0040, 0009	O	1	No	
>Modality	0008, 0060	R	1	No	Modality value = "XA" (*)

(\*) This means that matching is requested upon the provided value.

**5-4-5-2 SOP Common Module**

Attribute Name	Element Tag	Expected matching key type	Expected Returned key type	Mapped into the image	Notes
Specific Character Set	0008, 0005	O	1C	Yes	

**Note:** Incoming worklist files MUST NOT contain study UID with a length over 62 characters.







---

## **GE Medical Systems**

*GE Medical Systems: Telex 3797371  
P.O. Box 414, Milwaukee, Wisconsin 53201 U.S.A.  
(Asia, Pacific, Latin America, North America)*

*GE Medical Systems — Europe: Telex 698626  
283, rue de la Minière, B.P. 34, 78533 Buc Cedex  
France*