

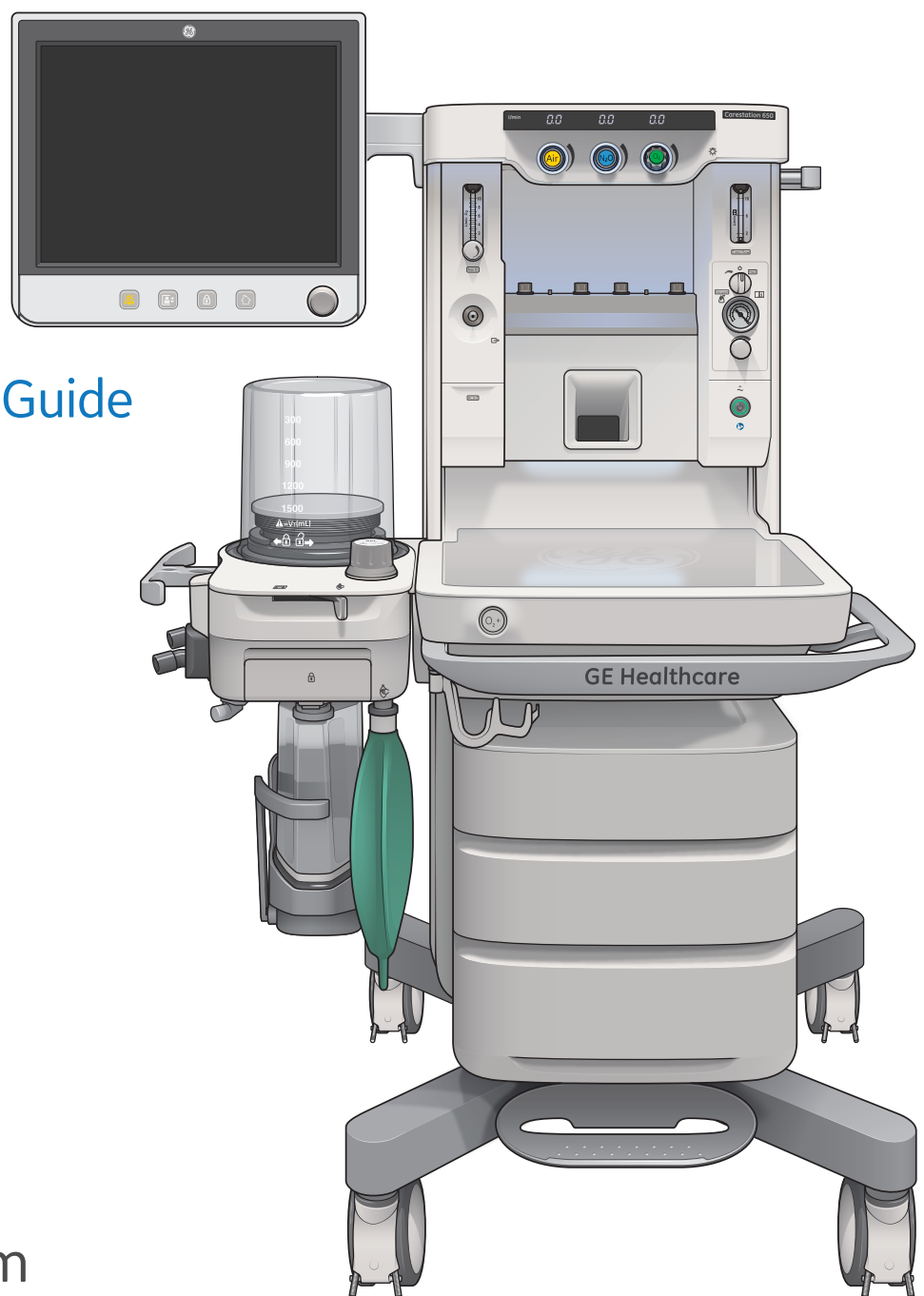

# Carestation 600 Series

Clinical Reference Guide  
U.S. Version



[gehealthcare.com](http://gehealthcare.com)





# Carestation 600 Series

## Clinical Reference Guide

U.S. Version

### **Notice**

The materials contained in this document are intended for educational purposes only. This document does not establish specifications, operating procedures or maintenance methods for any of the products referenced. Always refer to the official written materials (labeling) provided with the product for specifications, operating procedures and maintenance requirements.

# Contents

|  |           |   |           |
|--|-----------|---|-----------|
| <b>01 Introduction</b> .....                 | <b>1</b>  | <b>06 Alarms and Trends</b> .....         | <b>25</b> |
| Intended Use .....                           | 1         | Setting Alarm Limits .....                | 25        |
| Feature Overview .....                       | 2         | Additional Alarm Settings .....           | 26        |
| Indications for Use .....                    | 3         | Setting Auto Limits .....                 | 26        |
| <b>02 System Overview</b> .....              | <b>5</b>  | Viewing Trends .....                      | 27        |
| Front View Components .....                  | 5         | <b>07 Ventilation Modes</b> .....         | <b>29</b> |
| Right Side View Components .....             | 6         | Ventilation Modes Overview .....          | 29        |
| Rear View Components .....                   | 7         | VCV .....                                 | 30        |
| Left Side View Components .....              | 8         | PCV .....                                 | 30        |
| Breathing Circuit Components .....           | 9         | PCV-VG .....                              | 31        |
| Central and Caster Brakes .....              | 10        | SIMV VCV .....                            | 32        |
| Positioning the Display .....                | 11        | SIMV PCV .....                            | 33        |
| Using the Bag Support Arm .....              | 11        | SIMV PCV-VG .....                         | 34        |
| <b>03 Navigation Display Controls</b> .....  | <b>12</b> | PSVPro .....                              | 35        |
| Display Touch Points .....                   | 13        | CPAP + PSV .....                          | 35        |
| Areas of an Active Display .....             | 14        | <b>08 End Case and Standby</b> .....      | <b>37</b> |
| Using Menus .....                            | 15        | Ending a Case .....                       | 37        |
| Using the ComWheel .....                     | 15        | Standby .....                             | 38        |
| Using Ventilator Quick Keys .....            | 16        | Turning off the System .....              | 38        |
| <b>04 Operation Overview</b> .....           | <b>17</b> | <b>08 Checkout</b> .....                  | <b>39</b> |
| Turning on the System .....                  | 17        | Checkout Overview .....                   | 39        |
| Fresh Gas Control .....                      | 17        | Checkout: Full Test .....                 | 40        |
| Using the O <sub>2</sub> Flush Button .....  | 18        | <b>09 ecoFLOW</b> .....                   | <b>41</b> |
| Using the APL Valve .....                    | 18        | Overview .....                            | 41        |
| Using the Bag/Vent Switch .....              | 19        | Benefits of Low Flow Anesthesia .....     | 42        |
| Using the Vaporizer .....                    | 19        | Menu Components .....                     | 42        |
| <b>05 Starting a Case</b> .....              | <b>20</b> | Activating the ecoFLOW Split Screen ..... | 43        |
| Start Case Menu Overview .....               | 20        | <b>10 Procedures</b> .....                | <b>45</b> |
| Starting a Case Using Default Setting .....  | 21        | Overview .....                            | 45        |
| Starting a Case Using Custom Settings .....  | 21        | Pause Gas Flow .....                      | 46        |
| Starting Manual Ventilation .....            | 22        | Cardiac Bypass .....                      | 47        |
| Starting Mechanical Ventilation .....        | 22        | Vital Capacity .....                      | 48        |
| Changing a Ventilator Mode and Setting ..... | 23        | Cycling .....                             | 49        |



|  |           |   |           |
|--|-----------|---|-----------|
| <b>11 Spirometry .....</b>                         | <b>51</b> | <b>16 User Maintenance and Testing .....</b>      | <b>75</b> |
| Overview .....                                     | 51        | Calibrating the O <sub>2</sub> Cell .....         | 75        |
| Setting a Spirometry Loop type .....               | 52        | Calibrating the Flow Sensors .....                | 76        |
| Setting Loop Graph Scaling .....                   | 52        | Calibrating the Airway Module .....               | 77        |
| Setting the Data Source .....                      | 53        | Maintenance Summary and Schedule .....            | 78        |
| Setting Patient and Sensor Type .....              | 53        | Low Pressure Leak Test (with ACGO) .....          | 79        |
| Changing Spirometry Volume type .....              | 54        | <b>17 Pneumatic Connections .....</b>             | <b>81</b> |
| Saving, Viewing and Deleting Spirometry loops ..   | 54        | Pipeline Inlets .....                             | 81        |
| <b>12 Screen Setup .....</b>                       | <b>55</b> | Suction Connections (Optional) .....              | 82        |
| Overview .....                                     | 55        | Pneumatic Connections .....                       | 83        |
| Setting Waveform Fields .....                      | 56        | <b>18 Installing Gas Cylinders .....</b>          | <b>85</b> |
| Setting Digit Fields .....                         | 56        | Overview .....                                    | 85        |
| Setting Split Screen .....                         | 57        | Installing Cylinders with Pin Indexed Yokes ..... | 86        |
| <b>13 Integrated Auxiliary Options .....</b>       | <b>59</b> | Performing a High-Pressure Leak Test .....        | 87        |
| Using the ACGO .....                               | 59        |   |           |
| The ACGO Display .....                             | 60        |   |           |
| Using Aux O <sub>2</sub> +Air .....                | 61        |   |           |
| The Aux O <sub>2</sub> +Air Display .....          | 62        |   |           |
| Auxiliary O <sub>2</sub> (Optional) .....          | 63        |   |           |
| <b>14 Alarm Setup .....</b>                        | <b>65</b> |   |           |
| Accessing the Alarm Setup Menu .....               | 65        |   |           |
| Alarm Setup Menu Overview .....                    | 66        |   |           |
| CO <sub>2</sub> , Vol Apnea and MV/TV Alarms ..... | 66        |   |           |
| The Alarm Setup Configure Menu .....               | 67        |   |           |
| <b>14 Super User .....</b>                         | <b>69</b> |   |           |
| Overview .....                                     | 69        |   |           |
| Examples of Super User Settings .....              | 70        |   |           |
| <b>15 Setting up the Absorber Canister .....</b>   | <b>71</b> |   |           |
| Overview .....                                     | 71        |   |           |
| Removing the Absorber Canister .....               | 72        |   |           |
| Filling the Absorber Canister .....                | 72        |   |           |
| Filling the Reusable Absorber Canister .....       | 73        |   |           |



# 01 Introduction

## Intended Use

The Carestation 600 series anesthesia system combines advanced anesthesia delivery, patient monitoring, and care information management. The contemporary, compact design addresses many ergonomic considerations including an efficient cable management solution and storage system and a large work surface area.

Optional integrated features include two position vaporizer manifold, auxiliary common gas outlet, auxiliary O<sub>2</sub>+Air outlet, and suction control. The system provides integration of ventilation, gas delivery and gas monitoring, on a 15-inch color touchscreen interface.

This anesthesia system is designed for mixing and delivering inhalation anesthetics, Air, O<sub>2</sub>, and N<sub>2</sub>O.



# Feature Overview

There are three main system configurations available: Carestation 620, Carestation 650 and Carestation 650c. The Carestation 650c Wall/Pendant Mount configurations are the same as the Carestation 650, except for the following:

- 2 drawers included
- No trolley/casters/brakes
- Mounts to pendant, wall or rails
- No AC outlets available
- No cylinders available

| Feature   | Carestation 620  | Carestation 650     |
|---|------------------|---------------------|
| <b>Hardware Features</b>                                      |                  |                     |
| Anesthesia display arm  | 1-pivot, no tilt | 2-pivots, with tilt |
| Central Brake, Caster Guards, Front Handle                    | Not available    | Included            |
| Drawers   | 3-Optional       | 3-Included          |
| Work surface metallic insert                                  | Not available    | Included            |
| Top Shelf Color   | White            | Black               |
| <b>Patient Monitoring Mounts</b>                              |                  |                     |
| Top Shelf   | Optional         | Optional            |
| Vertical mount, configured monitor (above anesthesia display) | Not available    | Optional            |
| B850 Mounting   | Not available    | Optional            |
| <b>Pneumatic Options</b>                                      |                  |                     |
| Fresh gas flow, LED Display (above controls)                  | Not available    | Included            |
| Aux O <sub>2</sub> +Air (Integrated, circle system controls)  | Not available    | Optional            |
| <b>Software - Ventilation Modes</b>                           |                  |                     |
| SIMV PCV-VG   | Not available    | Optional            |
| CPAP PSV  | Not available    | Optional            |
| <b>Advanced Software Features</b>                             |                  |                     |
| Spirometry  | Optional         | Included            |
| Auto Alarm Limits   | Not Available    | Included            |
| ecoFlow   | Not available    | Optional            |
| Pause Gas   | Not available    | Optional            |
| Cycling   | Not available    | Optional            |
| Vital Capacity  | Not available    | Optional            |

# Indications for Use

The Carestation 600 series anesthesia systems are intended to provide general inhalation anesthesia and ventilatory support to a wide range of patients (neonate, pediatric, and adult). The anesthesia systems are suitable for use in a patient environment, such as hospitals, surgical centers, or clinics. The systems are intended to be operated by a clinician qualified in the administration of general anesthesia.





# 02 System Overview

## Front View Components

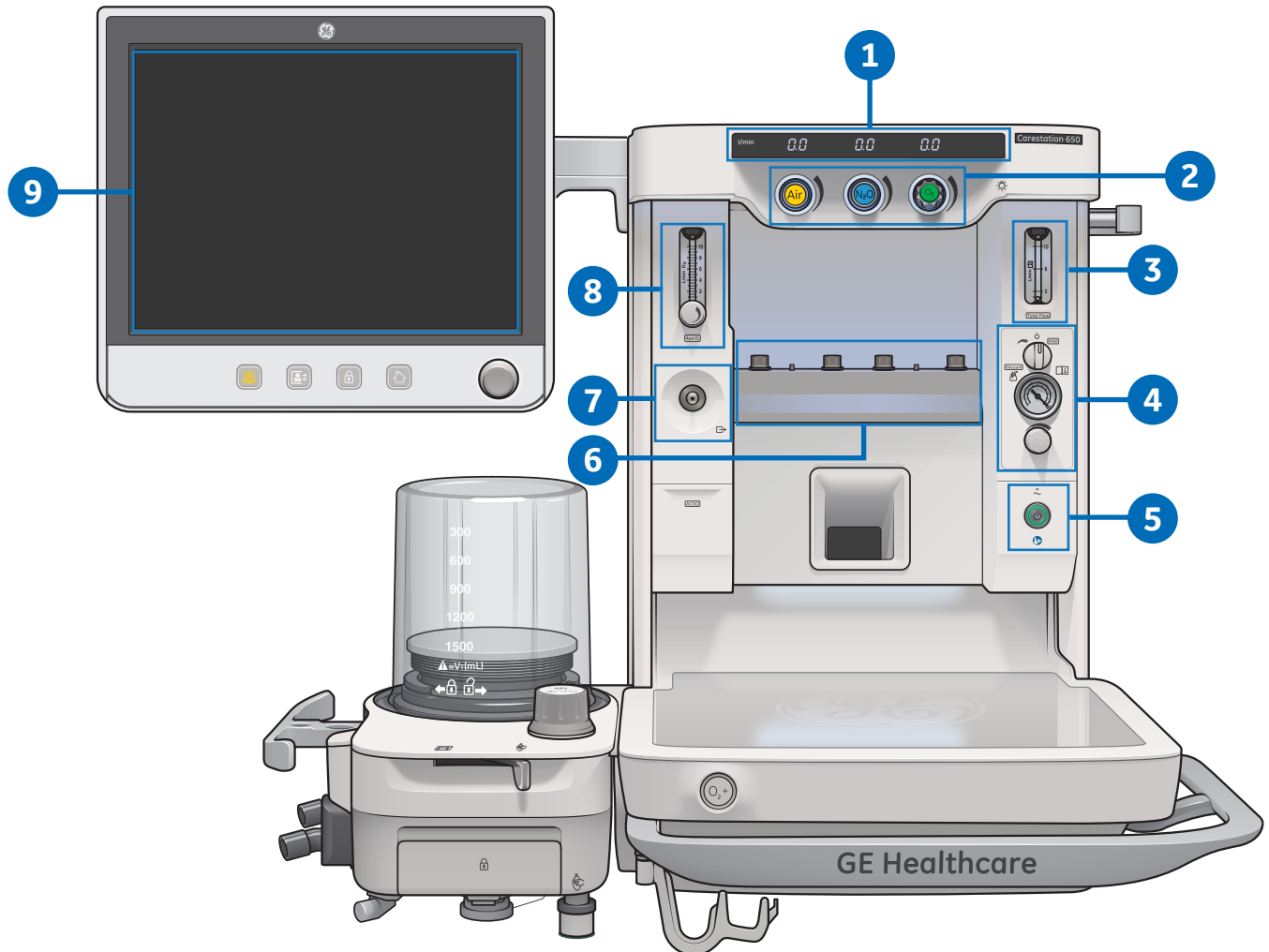

- 1. Digital Fresh Gas Display:** LED display for fresh gas flow. Fresh gas options include Air, N<sub>2</sub>O and O<sub>2</sub>.
- 2. Fresh Gas Control Knobs:** The fresh gas flow can be adjusted using the fresh gas control knobs. There is a flow control knob for each fresh gas on the system.
- 3. Total Fresh Gas Flow Meter:** Shows total fresh gas flow.
- 4. Suction Regulator and Control:** The vacuum suction regulatory uses an external vacuum supply. The venturi suction regulatory uses the system air or O<sub>2</sub> supply source.
- 5. On/Standby Switch:** Push the On/Standby switch for one second to turn on the system.
- 6. Vaporizer Manifold:** Vaporizers are installed on the vaporizer manifold.
- 7. Auxiliary O<sub>2</sub> Outlet:** The outlet port for the auxiliary O<sub>2</sub> flow control.
- 8. Auxiliary O<sub>2</sub> Flowmeter:** The auxiliary O<sub>2</sub> port is available to provide supplemental oxygen to patients undergoing surgical procedures.
- 9. Anesthesia Display:** The anesthesia display is used throughout the anesthesia delivery process and allows the clinician to interact with the system. The display also provides real-time patient data.



# Right Side View Components

- 1. Right Dovetail:** Dovetails are used to mount additional components to the system.
- 2. Pipeline Connections:** Hoses are connected between the pipeline connections and the gas outlets in the hospital.
- 3. Mains Inlet:** AC power is connected to the system through the mains inlet.
- 4. Outlets and Circuit Breakers:** Use the outlets to plug in low power accessories that are used in conjunction with the anesthesia machine.

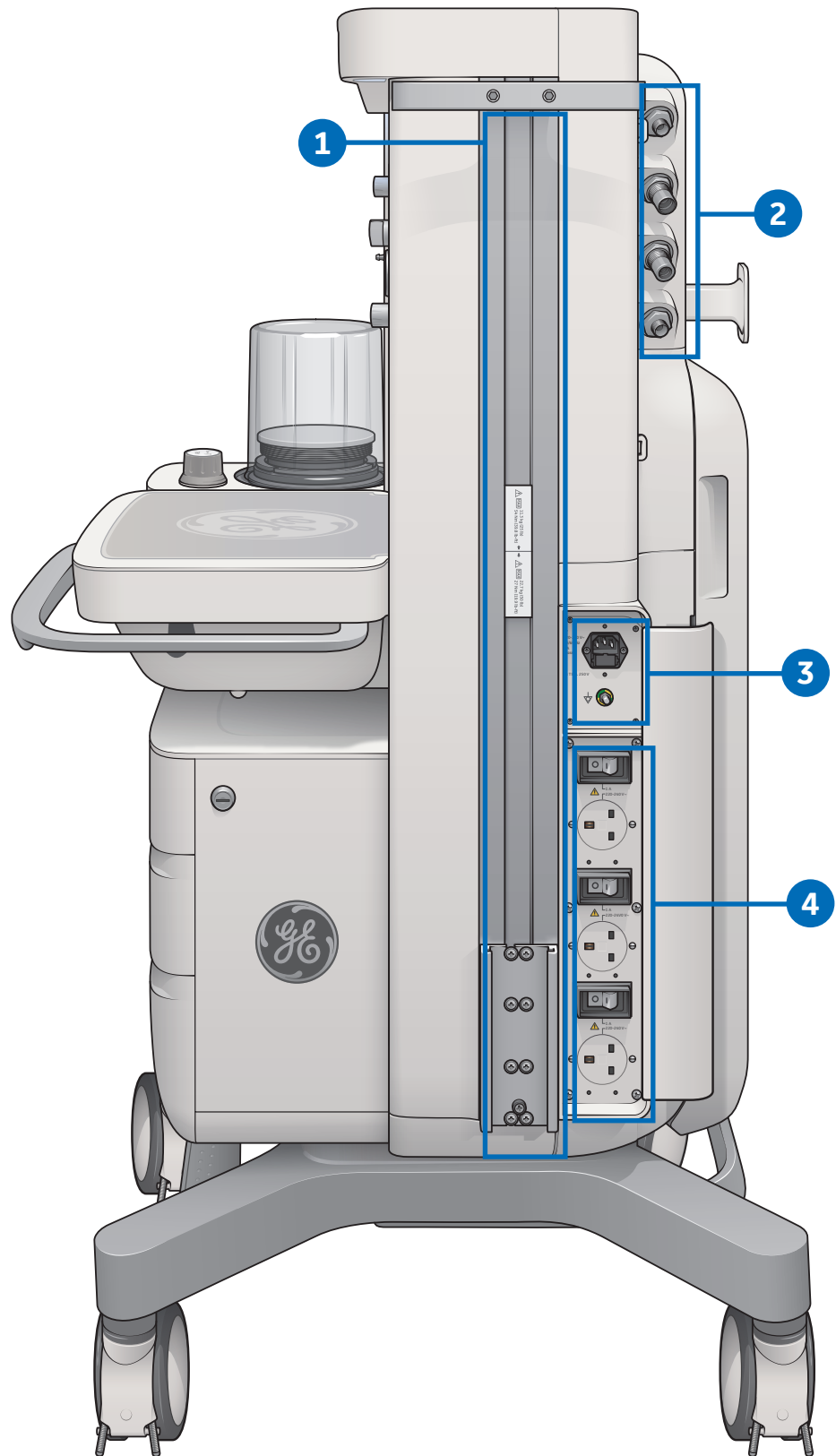



# Rear View Components

- 1. Display Arm:** The display can be moved for optimal viewing using the display arm.
- 2. Cable Hook:** Use the cable hooks to organize any cables.
- 3. Cylinder Yokes:** Gas cylinders are mounted on the cylinder yoke.
- 4. Caster Guard:** Caster guards are used to push cables and hoses away from the machine as it is being moved.

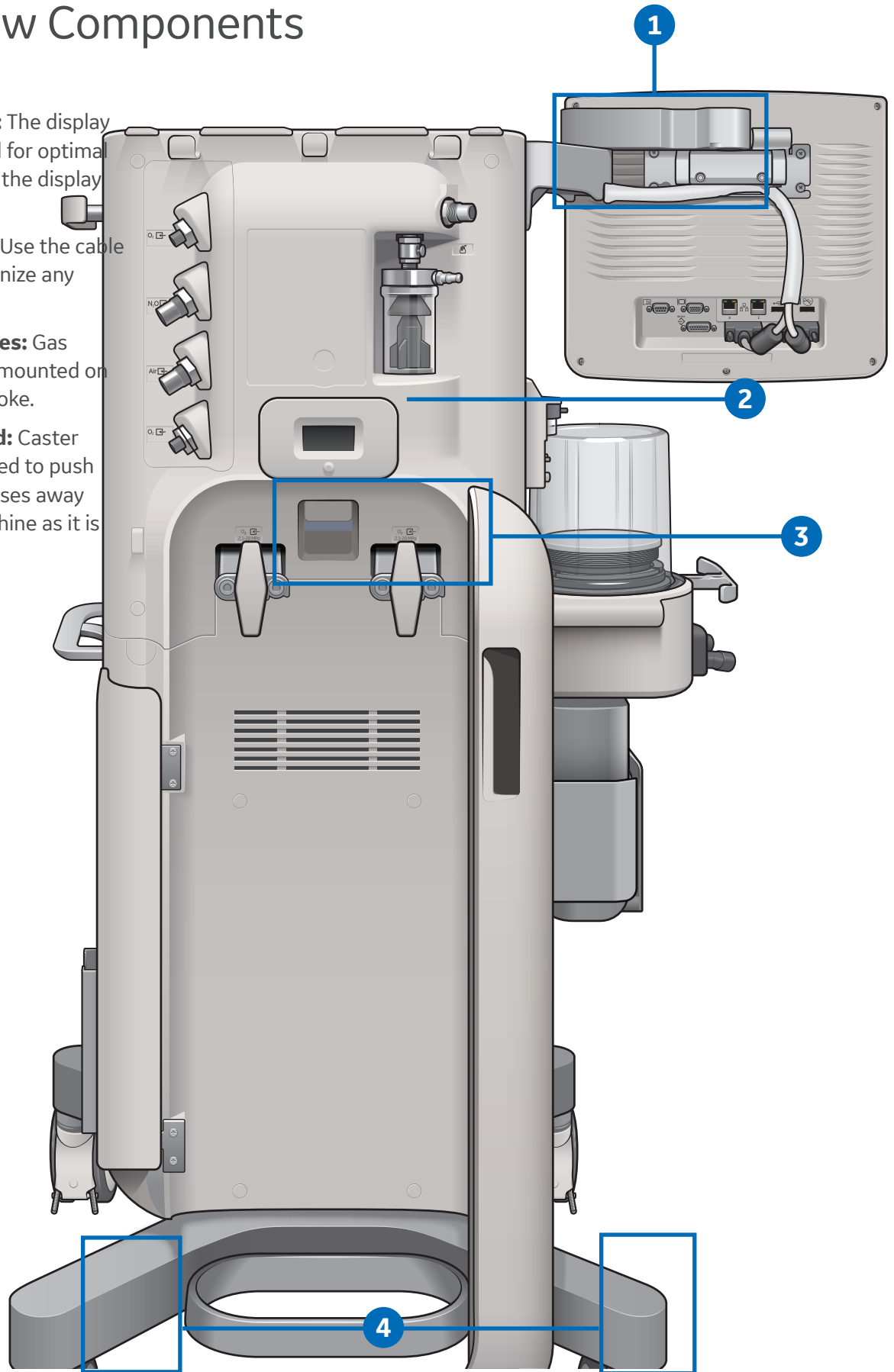

# Left Side View Components

## 1. Suction Trap and Suction

**Fitting:** The suction trap prevents fluids from entering the suction regulator.

## 2. Airway Module and Sample Gas

**Return Port:** The airway module measures and monitors gases delivered to the patient.

## 3. Anesthesia Gas Scavenging

**System (AGSS) Port:** Both active and passive scavenging systems are available to remove waste gas from the operating room environment.

## 4. Left Dovetail:

Dovetails are used to mount additional components to the system.

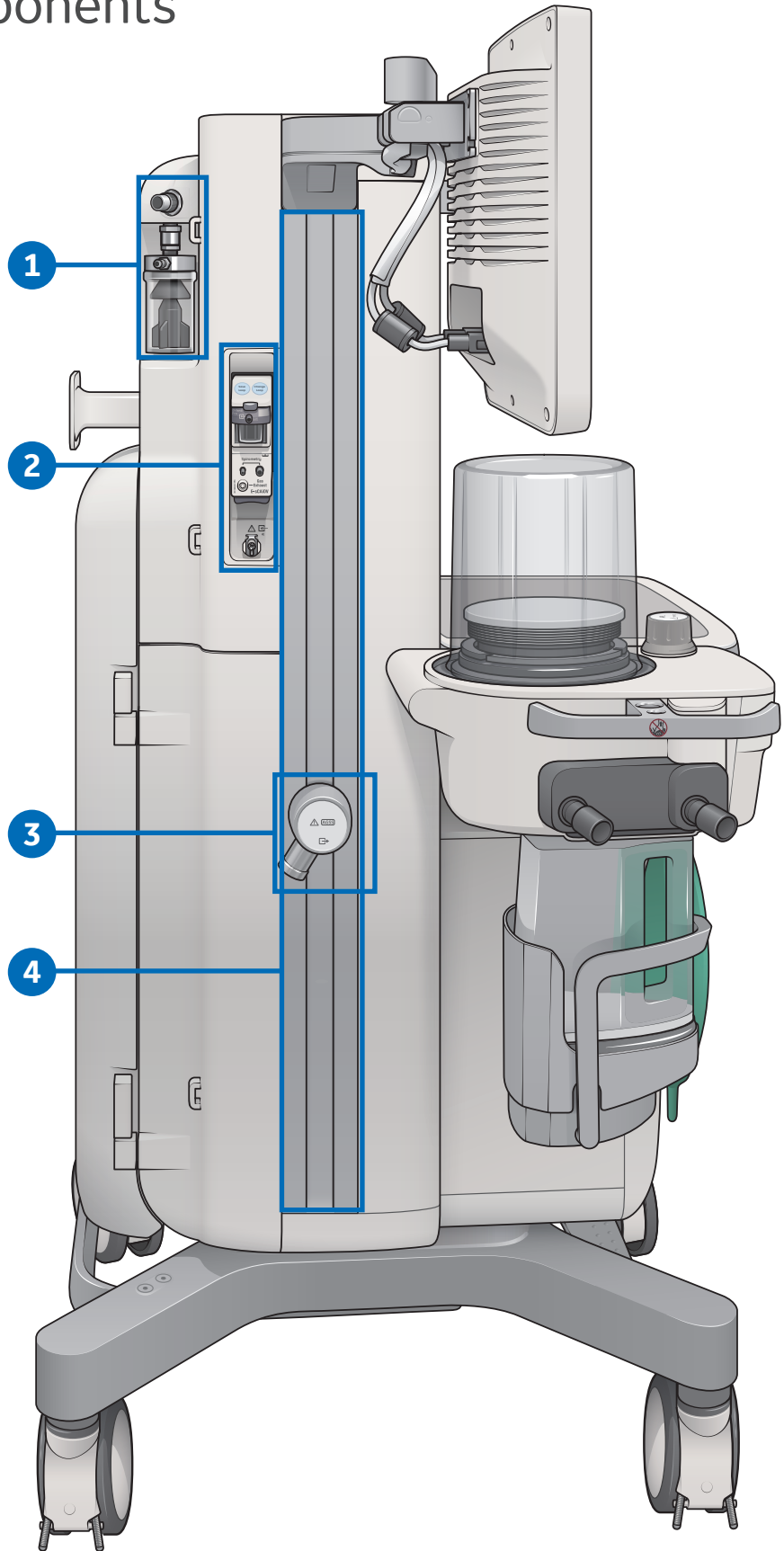

# Breathing Circuit Components

- 1. Bellows Assembly:** During mechanical ventilation, the gases that are to be delivered to the patient are contained within the bellows assembly.
- 2. Adjustable Pressure-Limiting (APL) Valve:** During manual ventilation, the APL Valve allows you to change the pressure limit.
- 3. Bag/Vent Switch:** Selects between manual ventilation (bag) and mechanical ventilation (ventilator).
- 4. Bag Hose Connection:** The breathing circuit bags connects to the bag hose connection.
- 5. Absorber Canister Lifter Handle:** Pull down the lifter handle to remove the absorber canister.
- 6. Absorber Canister:** Contains the material that removes carbon dioxide from the patient's exhaled breath. These scrubbed gases can then be sent back to the patient.
- 7. Leak Test Plug:** Used to occlude the breathing circuit during the checkout.
- 8. Inspiratory and Expiratory Ports:** The patient circuit connects to the inspiratory and expiratory ports.
- 9. Breathing System Guard:** Protects the breathing system from damage.

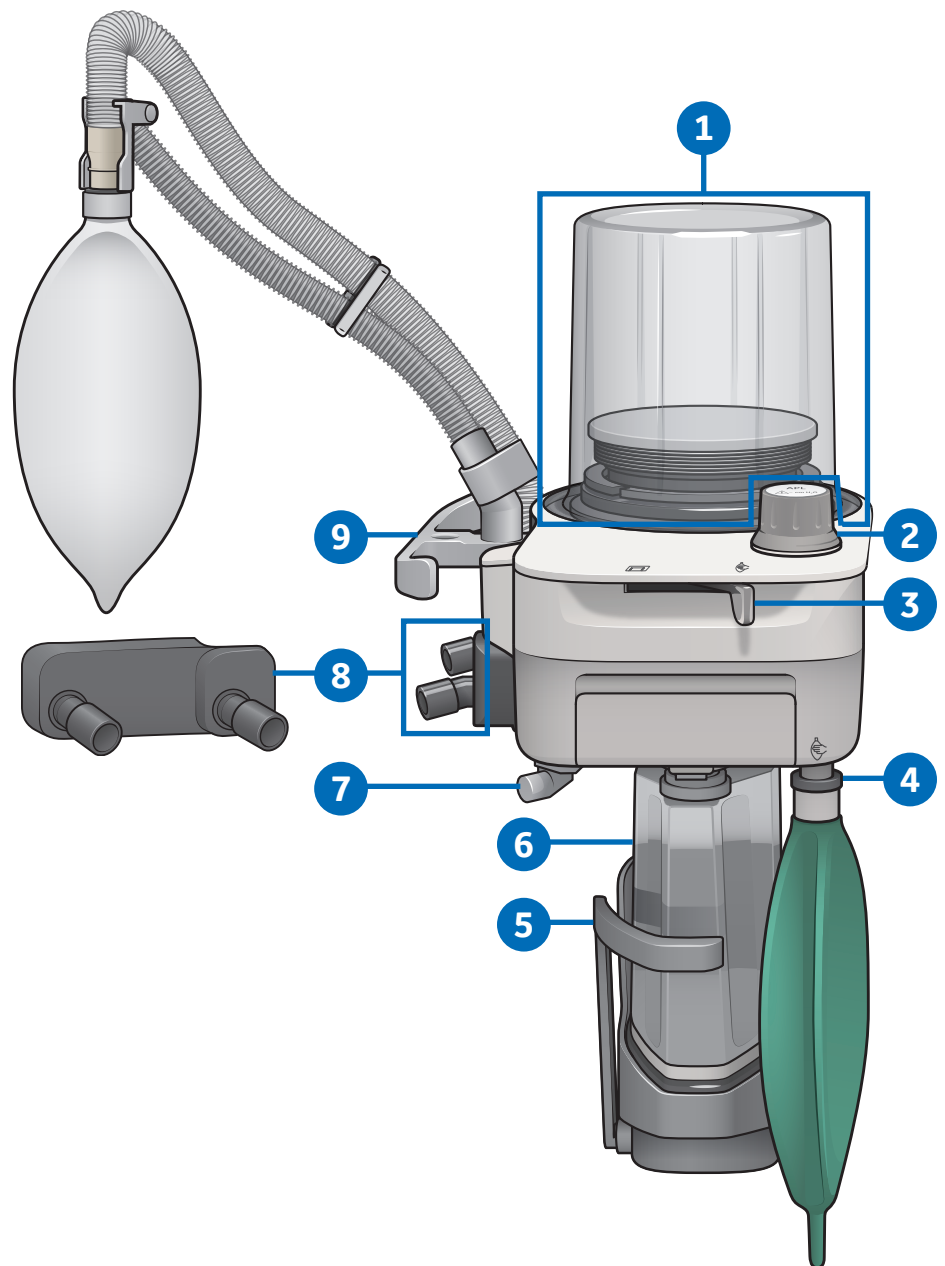

# Central and Caster Brakes

The system has two brake options that hold the system in place:

- One central brake with two brakes on the rear casters
- Brakes on the four casters

- 1. Central Brake:** Push down on the central brake to lock the system in place. Lift up on the central brake to release the brake.
- 2. Caster Brakes:** Push down on the lower portion of the brake pedal to lock the system in place. Push down on the upper portion of the brake to release the brake.



**Note:** Do not use the brake while moving the system. This could cause the machine to tip over. Only use the brake to keep the system in place.

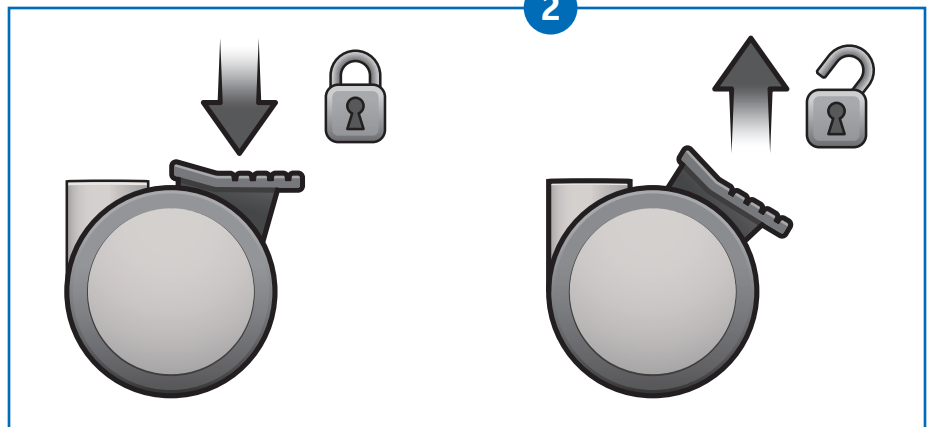
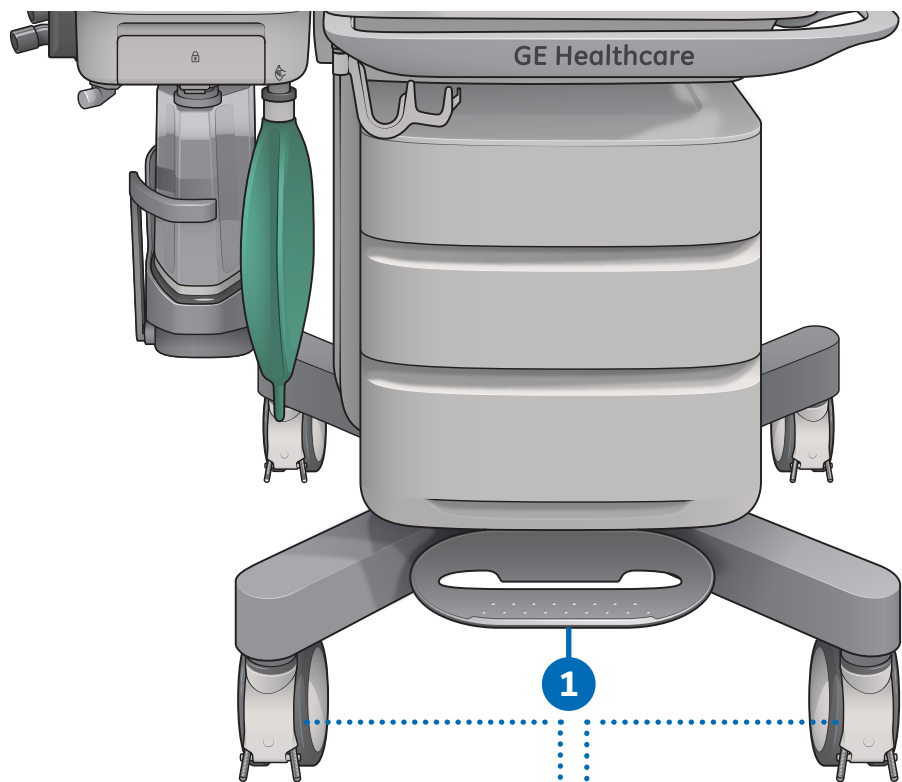

# Positioning the Display

The display can be moved for optimal viewing with two display arm options:

- Option one:** The display can be positioned closer to or further from the system, with only one pivot point and no tilt available.
- Option two:** The display can be positioned closer to or further from the system, can be tilted up or down, and can be rotated with two pivot points (650/650c only).

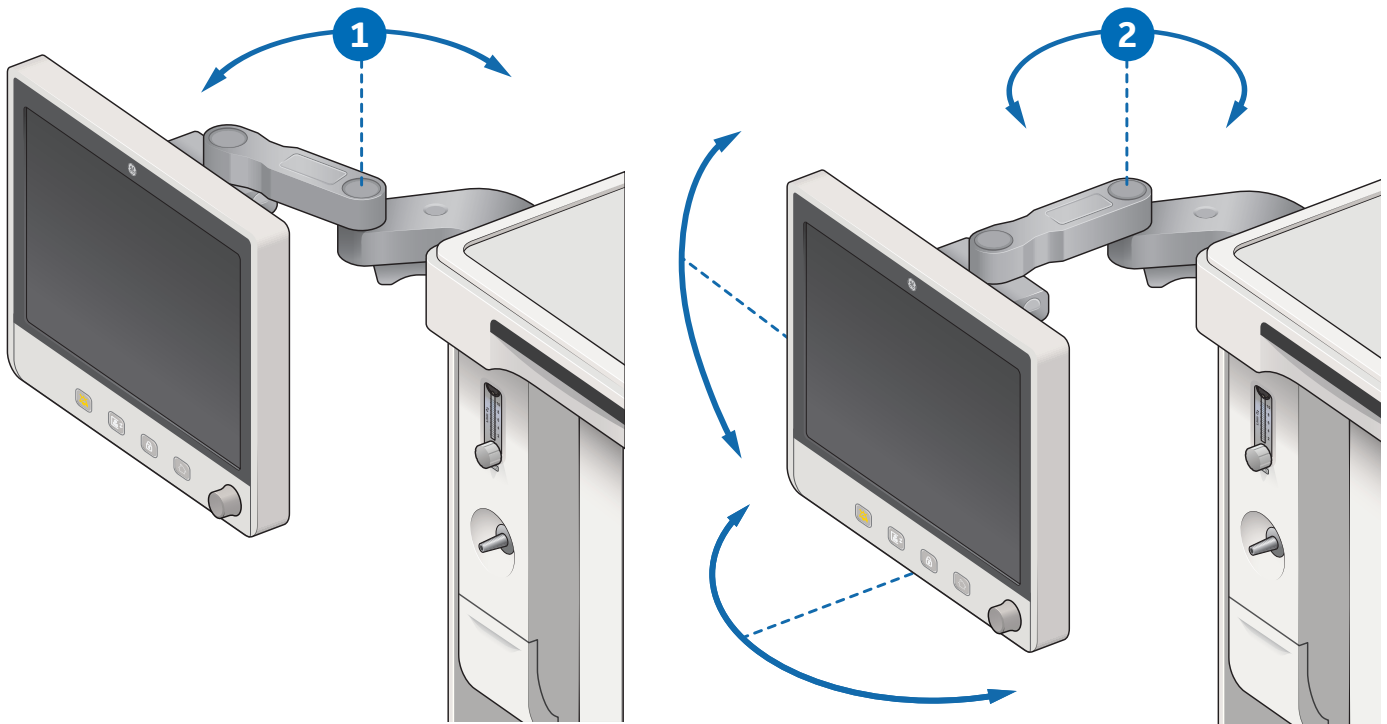

# Using the Bag Support Arm

Use the optional bag support arm to hold the breathing circuit bag. For optimal use it can be moved up or down and left or right

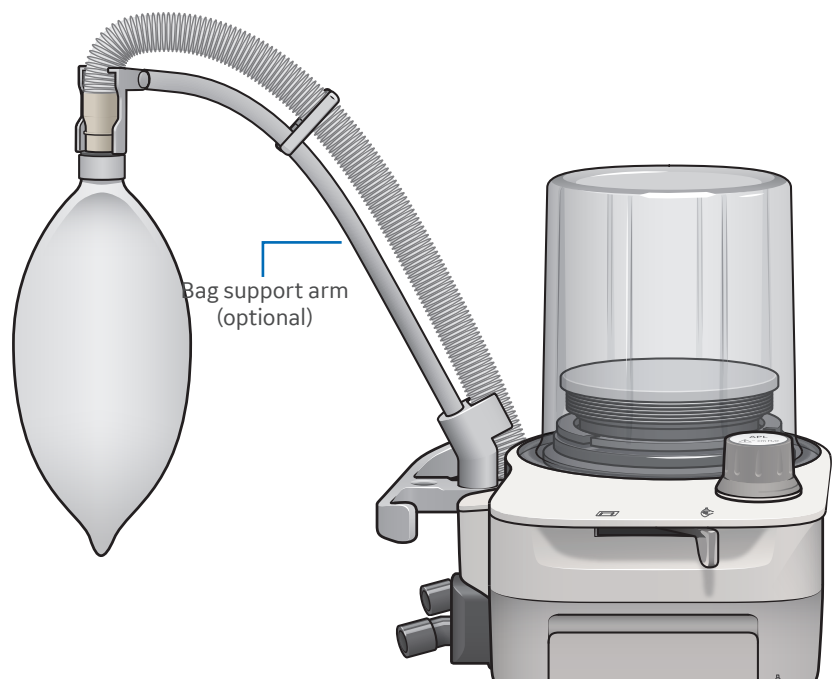

# 03 Navigation

## Display Controls

The system uses touchscreen technology, hard keys, and a ComWheel to access system functions, menus, and settings.

The touchscreen has numerous touch point areas that make accessing menus and settings quick and easy. The buttons on the right side of the screen provide direct access to commonly used functions. The ventilation quick keys enable setup of ventilation modes. Touch only one touch point at a time to ensure the correct selection is made.

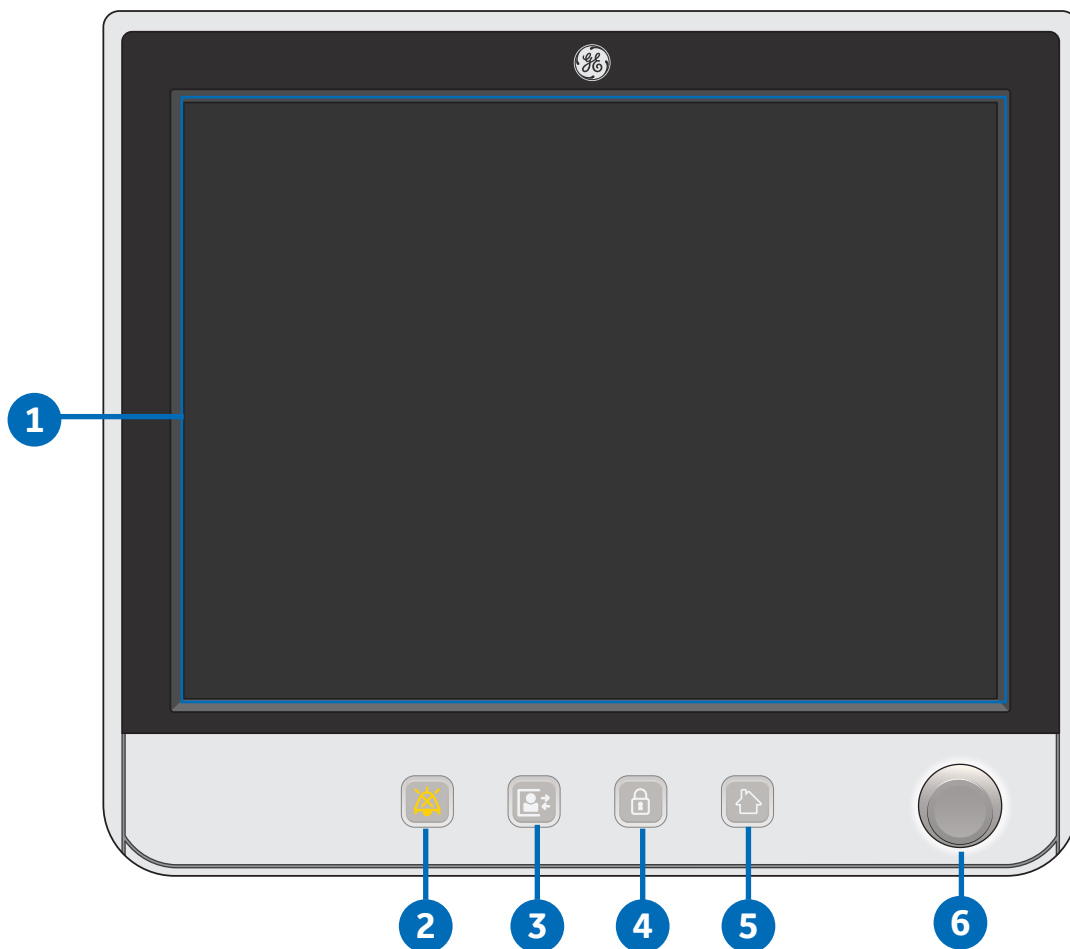

- 1. Touchscreen:** Activates functions when touch areas on the screen are selected.
- 2. Audio Pause Key:** Stops audio for 120 seconds for any active, eligible high and medium priority alarms.
- 3. Start/End Case Key:** Initiates Start or End Case function.
- 4. Screen Lock/Unlock Key:** Toggles between lock and unlock functions.
- 5. Home Key:** Removes all menus from the screen.
- 6. ComWheel:** Selects a menu item or confirms a setting. Turn clockwise or counterclockwise to scroll through menu items or change settings.

# Display Touch Points

The six display touch points will activate functions when the touch areas shown are selected.

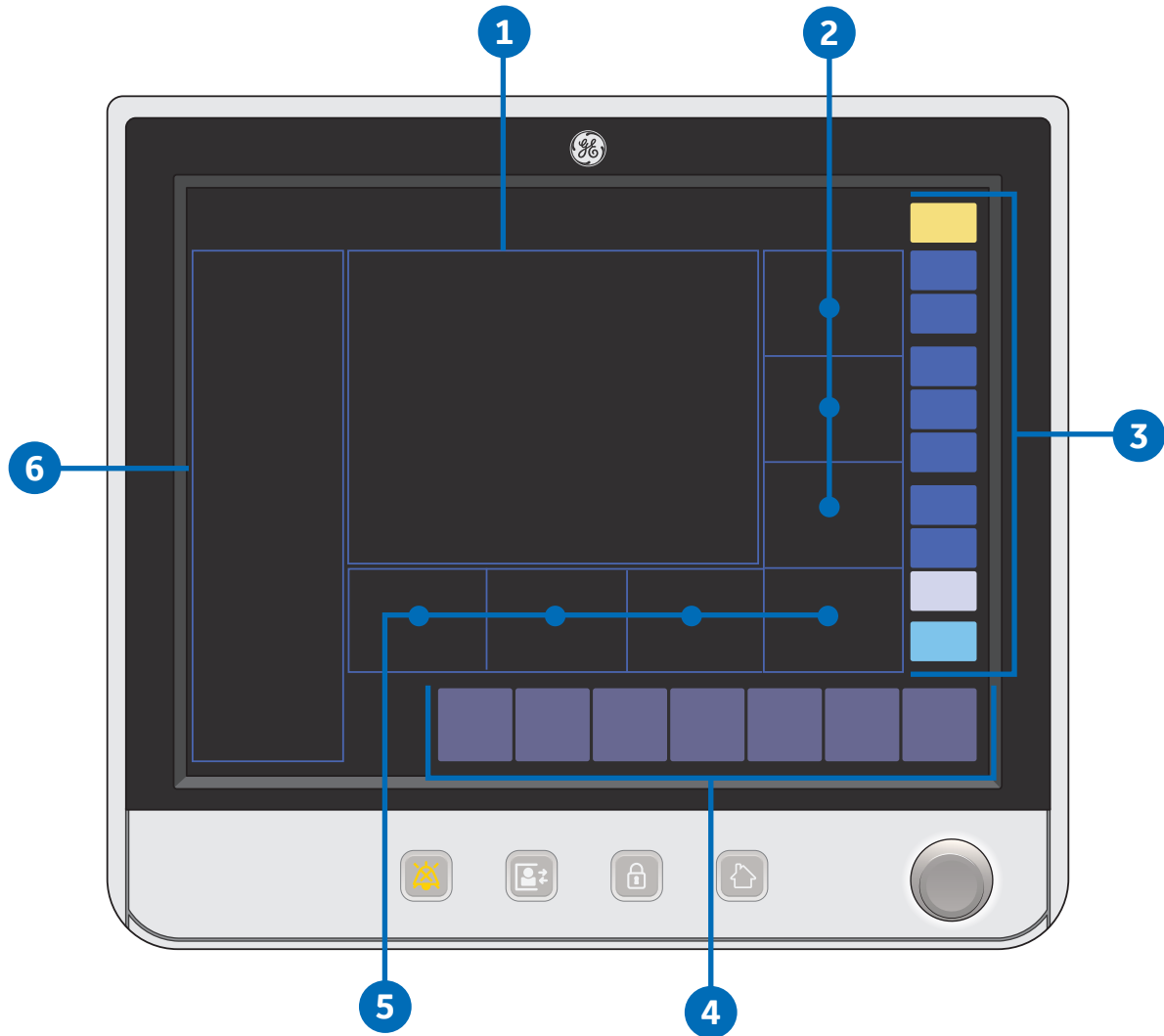

1. Wave Fields
2. Measured Values
3. Function Keys
4. Ventilator Quick Keys
5. Digit fields
6. Split Screen Values

Touching the measured values touch area provides access to the Alarm Setup menu and alarm limits.

When an alarm sounds the alarm message is displayed at the top of the screen and, if applicable, the alarming numeric field and digit field flashes. Touch the flashing numeric field to access the Alarm Setup menu and alarm limits for the active alarm.

# Areas of an Active Display

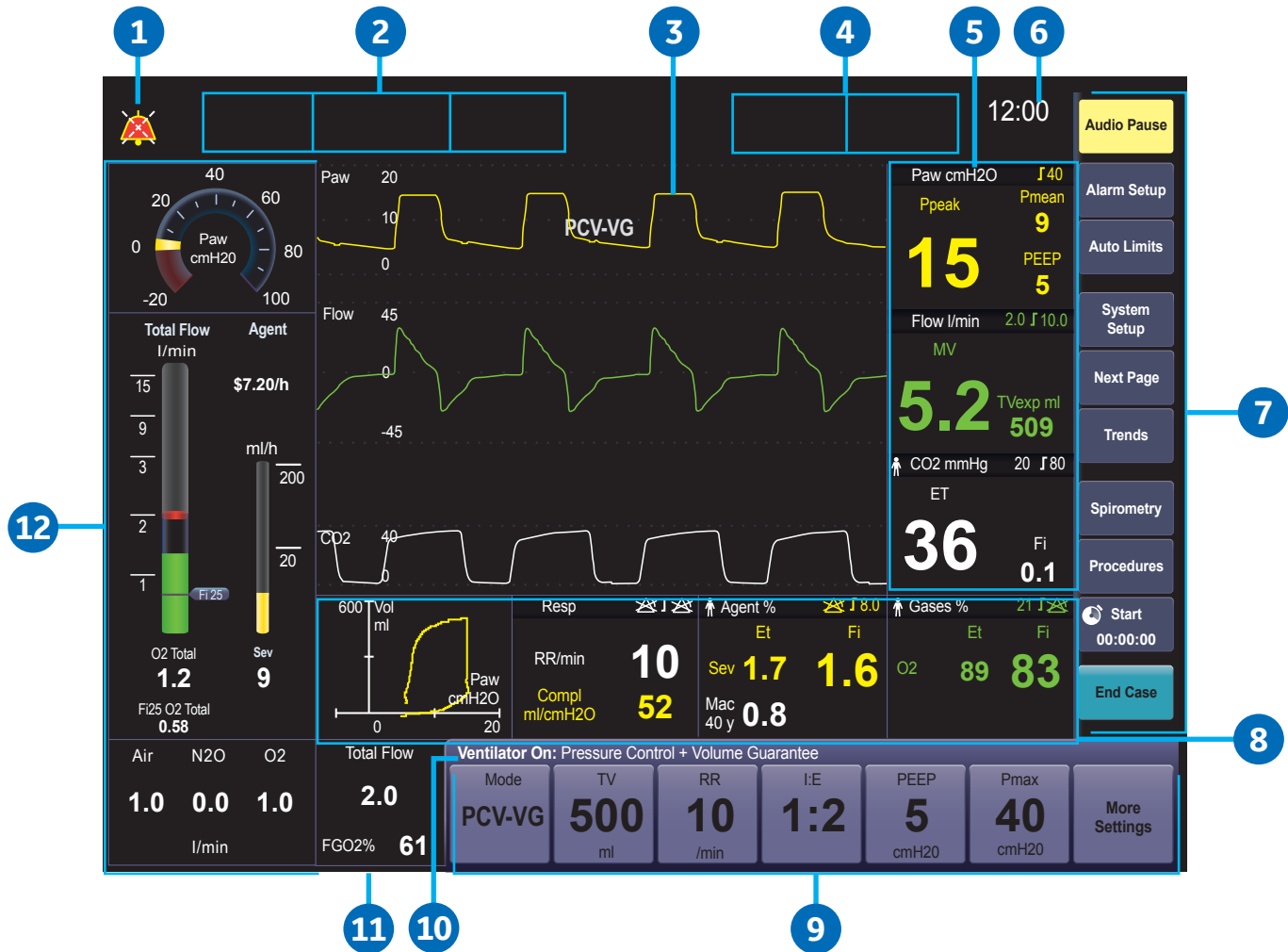

- 1. Audio pause symbol and countdown clock:** Indicates when alarm audio is paused and the countdown clock until audio is on.
- 2. Alarm message fields:** Displays the active alarms.
- 3. Waveform field:** Displays the waveforms of measured values. For example: Paw, Flow, and CO<sub>2</sub>.
- 4. General message fields or lock touchscreen indicator:** Displays general messages and the touchscreen lock indicator.
- 5. Measured values fields:** Displays the measured values. For example: Paw, Flow, and CO<sub>2</sub>.
- 6. Clock:** Displays the current time.
- 7. Function keys:** Functions available are: Audio Pause, Alarm Setup, Auto Limits, System Setup, Next Page, Trends, Spirometry, Procedures, Timer, Start, and End Case.
- 8. Digit fields:** Contains information for Loops, Resp, Agent, Gas Supplies, Flow, and Gases.
- 9. Ventilator quick keys:** Displays Mode, associated ventilation parameters, and More Settings. For example: Mode, TV, RR, I:E, Tpause PEEP, and Pmax.
- 10. Ventilation mode:** Displays the selected ventilation mode. For example: Ventilator Off and Volume Control.
- 11. Total Flow:** Contains information for Total Flow and FGO<sub>2</sub> %.
- 12. Split screen:** Contains airway pressure, gas flow values, compliance, trends, spirometry and optional ecoFLOW information.



# Using Menus

- 1. Menu:** Displays the title of the open menu.  
For example: **Start Case**.
- 2. Menu Items:** Select a menu item to choose the item, or turn the ComWheel to highlight a menu item and then push to confirm.
- 3. Instructions or Help Information:** This shows any additional instructions or help messages.

Use the function keys to access the corresponding menus. When a menu is selected, the menu field overlays the normal view and the waveform fields start at the right edge of the menu.

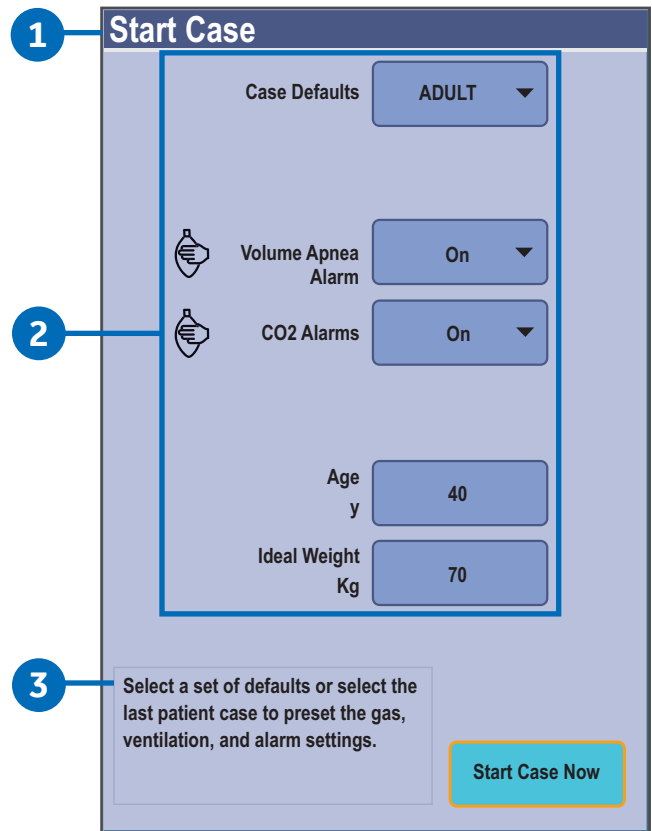

# Using the ComWheel

Use the ComWheel to scroll through the quick key settings and function keys, make selections, change settings, and confirm settings.

- Push the ComWheel to make a selection
- Turn the ComWheel to the right or left to highlight an item or change a setting
- Push the ComWheel to confirm a setting



# Using Ventilator Quick Keys

The main ventilator settings for each ventilation mode can be changed using the ventilator quick keys.

1. Select a quick key to open the menu or select a parameter.
2. If **Mode** or **More Settings** is selected, a menu displays. Select the desired value on the menu by touching the value. If any other quick key is selected, the value displays with a highlight. Turn the ComWheel left or right to set the desired value.
3. Push the ComWheel or select the quick key to confirm the change.

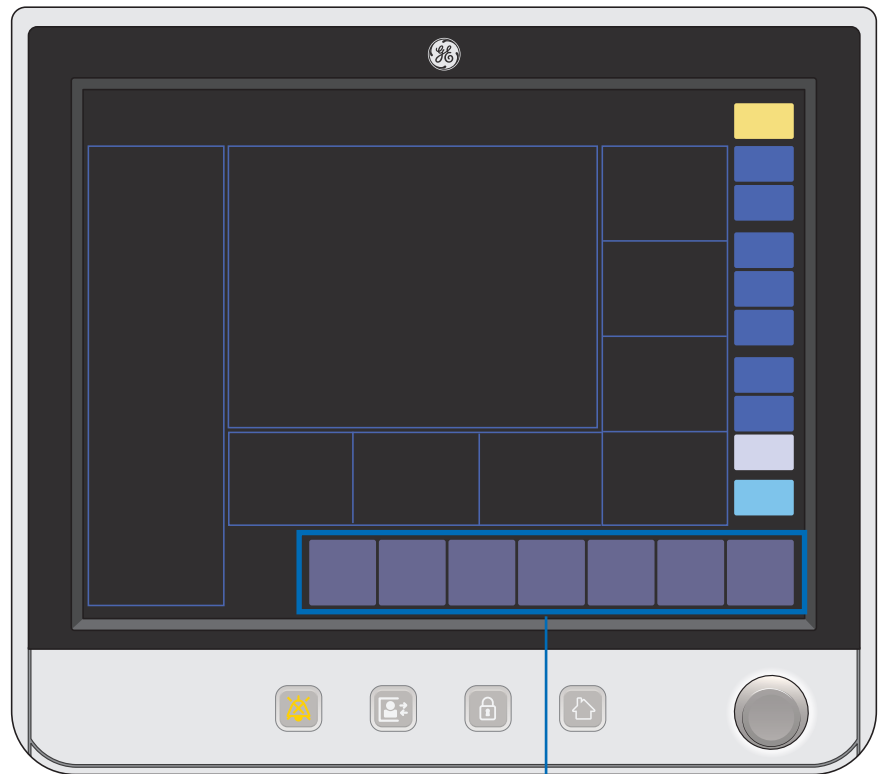

Ventilator Quick Keys

# 04 Operation Overview

## Turning on the System

1. Plug the power cord into an electrical outlet. Make sure the mains indicator light is on.
2. Push the On/Standby switch for one second to turn on the system.

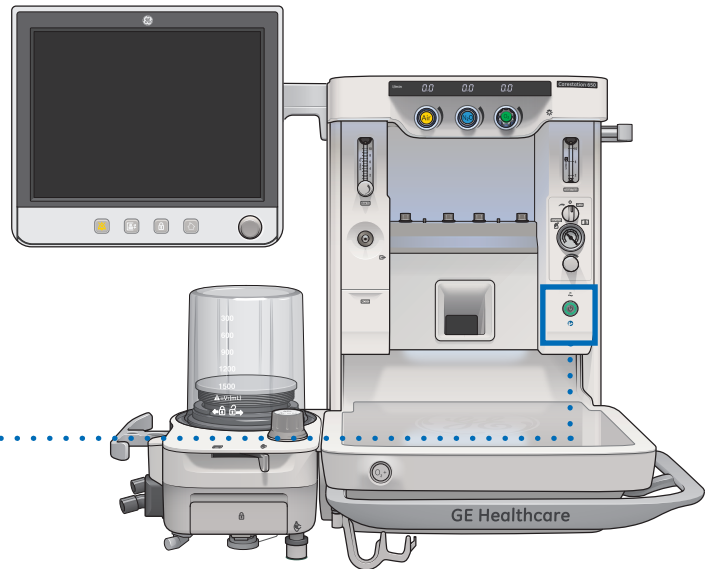
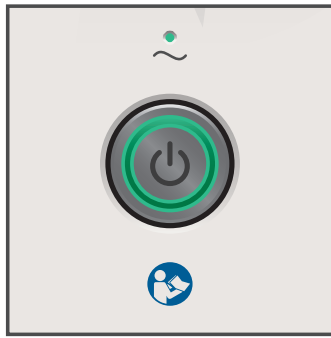

## Fresh Gas Control

1. The fresh gas flow will be displayed on the LED display directly above the control knobs.
2. Turn the fresh gas control knobs counter-clockwise to increase the flow and clockwise to decrease the flow.

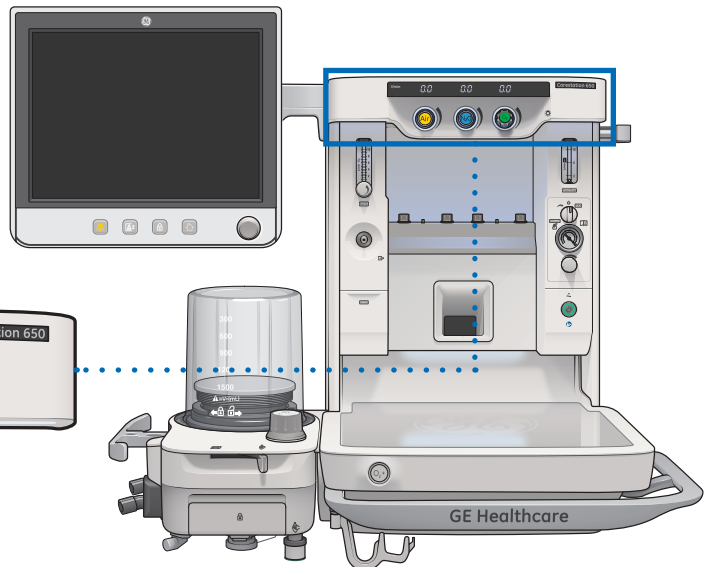

# Using the O<sub>2</sub> Flush Button

The O<sub>2</sub> flush button supplies a high flow of O<sub>2</sub> to the breathing system.

1. Push the O<sub>2</sub> flush button to deliver a high flow of O<sub>2</sub>.
2. Release the O<sub>2</sub> flush button to stop the delivery of a high flow of O<sub>2</sub>.

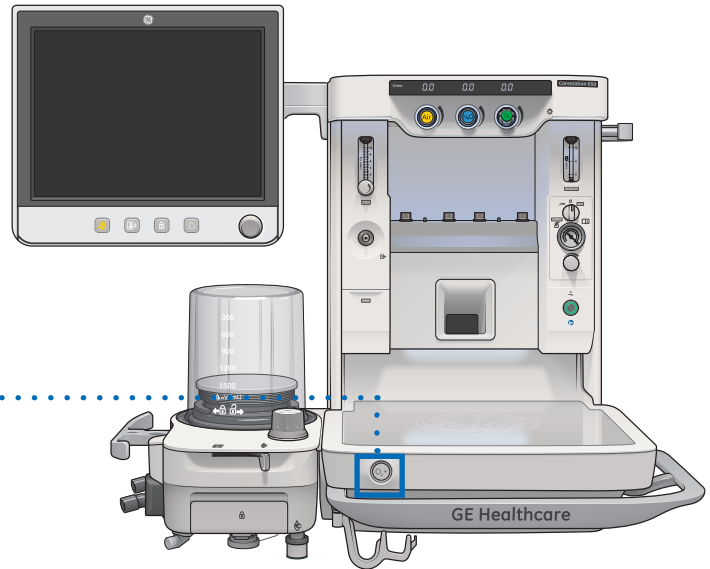
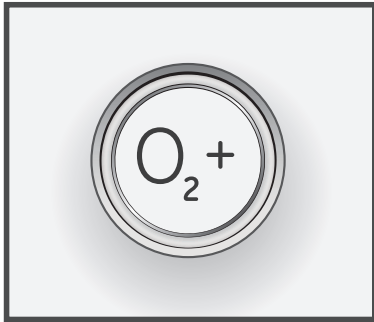

# Using the APL Valve

The Adjustable Pressure-Limiting (APL) Valve adjusts the breathing system pressure limit during manual ventilation. Turn the APL valve clockwise to increase the pressure limit, turn the APL valve counterclockwise to decrease the pressure limit.

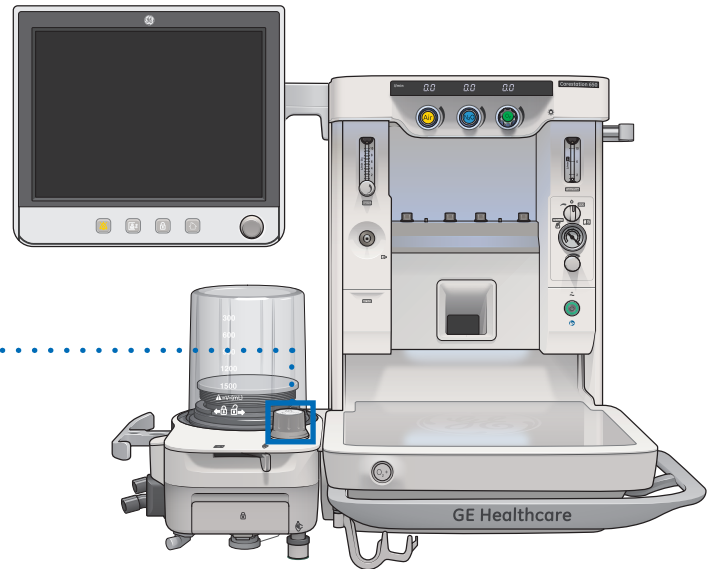

# Using the Bag/Vent Switch

The Bag/Vent Switch selects between manual ventilation (bag) and mechanical ventilation (ventilator).

1. Slide the switch to the right for manual ventilation
2. Slide the switch to the left for mechanical ventilation.

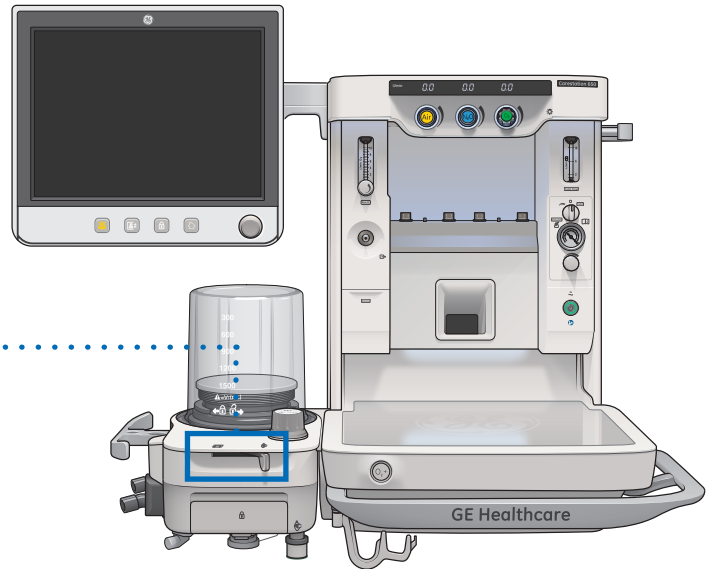
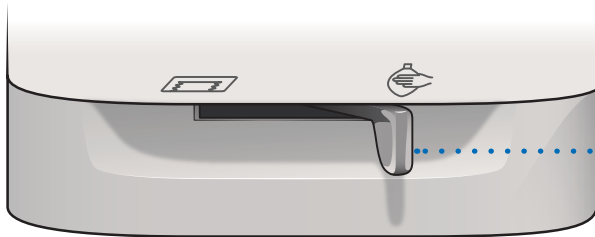

# Using the Vaporizer

1. Use only Selectatec series vaporizers Tec 6 Plus or greater.
2. Turn the lock lever full clockwise to lock the vaporizer in position.
3. Push the release and turn the concentration control to set the agent concentration.

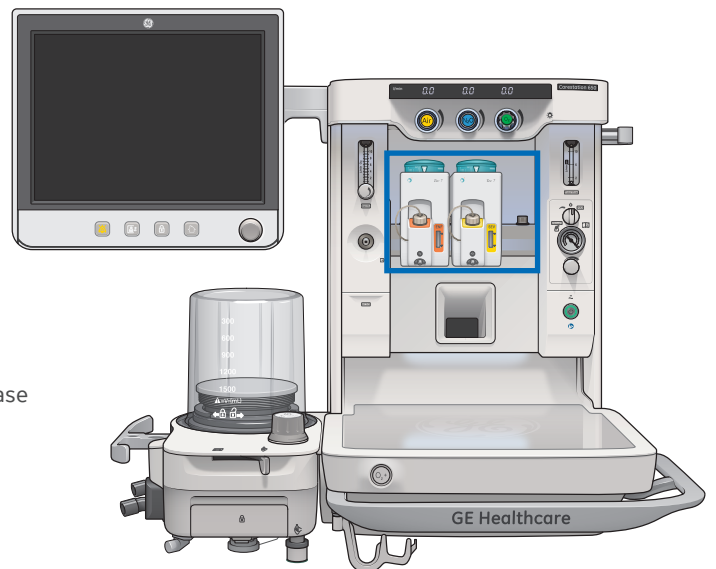

# 05 Starting a Case

## Start Case Menu Overview

1. Use the **Start Case** menu to set the case data and start the case. A case can be started using default settings or using custom settings. The **Case Defaults** selection shows the first of five default case types when the **Start Case** menu is accessed.
2. The **Volume Apnea Alarm**, **CO<sub>2</sub> Alarms**, **Age** and **Ideal Weight** values are set to the pre-selected settings defined by the Super User and corresponding to the case type.



**Note:** The default settings are configured by a Super User. A Super User is a person that has been given the authority to change default settings using a special password.

**Start Case**

Case Defaults **ADULT** ▼

Volume Apnea Alarm **On** ▼

CO<sub>2</sub> Alarms **On** ▼

Age y **40**

Ideal Weight Kg **70**

Select a set of defaults or select the last patient case to preset the gas, ventilation, and alarm settings.

**Start Case Now**

# Starting a Case Using Default Setting

Case Defaults contain five case type selections. Each case type has preset values for **Volume Apnea Alarm**, **CO<sub>2</sub> Alarms**, **Age** and **Ideal Weight**. The first four default case types are configured and named by the Super User. The fifth default case is **Last Case**.

1. Select **Start Case** from the bottom right of the display.
2. Verify or change the **Case Defaults** selected.
3. Verify the settings are clinically appropriate.
4. Select **Start Case Now**. Start gas flow by turning on the gas flow knobs.

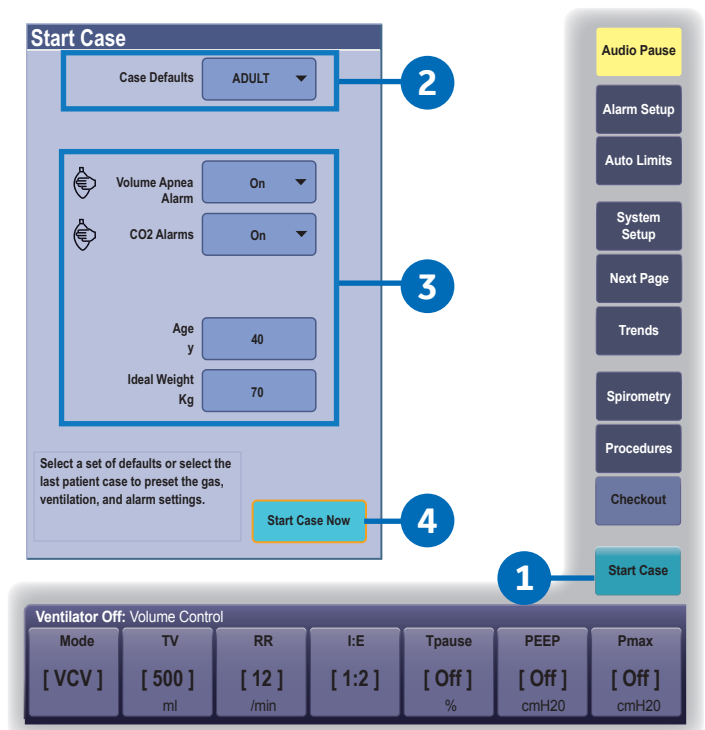

# Starting a Case Using Custom Settings

**Ideal Weight**, **Age**, **CO<sub>2</sub> Alarms**, and **Volume Apnea Alarm** can be custom set on the Start Case menu before starting a case.

1. Select **Start Case** from the bottom right of the display.
2. Change **Volume Apnea Alarm**, **Age** or **Ideal Weight** on the menu. The Case Defaults changes from the case name to Preset. If the **CO<sub>2</sub> Alarms** setting on the menu is changed, the **Case Defaults** remains as previously selected.
3. To change ventilation mode, select **Mode** from the bottom of the display. Make the change. To change the ventilation settings, select a ventilator quick key or **More Settings**. Make the change.
4. To change alarm settings, select **Alarm Setup** from the top right of the display. Make the change.
5. From the Start Case menu, select **Start Case Now**. Start gas flow by turning on the gas flow knobs.

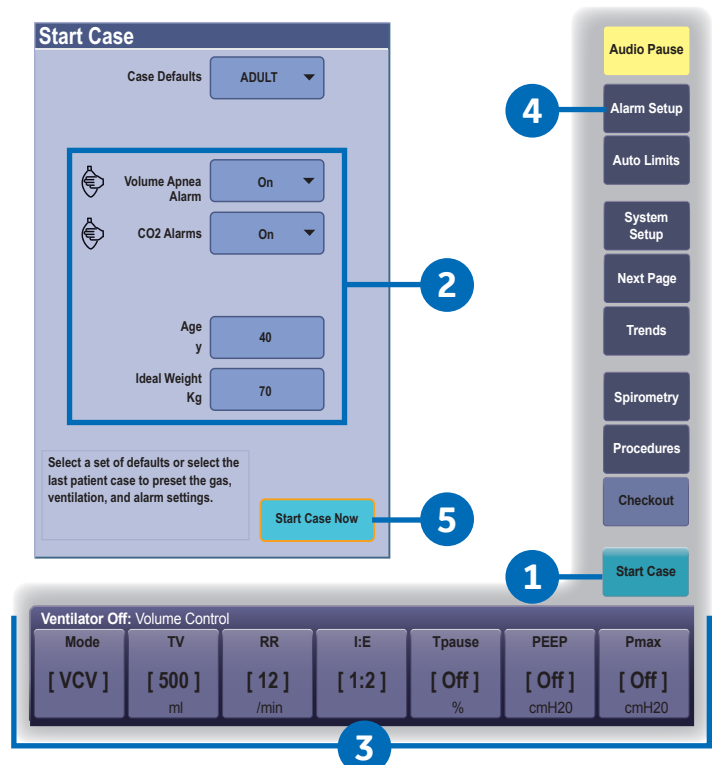

# Starting Manual Ventilation

1. Connect a manual breathing circuit.
2. Make sure the APL valve is set to a clinically appropriate value.
3. Set the Bag/Vent switch to Bag.

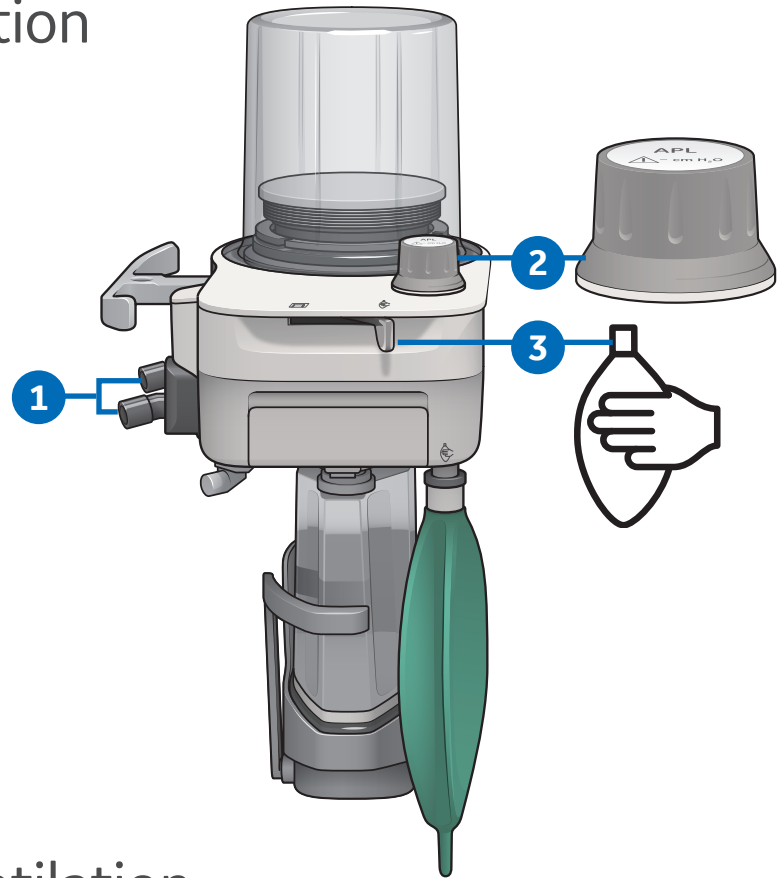

# Starting Mechanical Ventilation

1. Set the ACGO switch to the circle circuit position.
2. Set the Bag/Vent switch. If Bag/Vent switch is set to Bag, move to Vent position to start mechanical ventilation.
3. If needed, push the O<sub>2</sub> flush button to inflate the bellows.

**Note:** Make sure that the patient breathing circuit is correctly assembled and that the ventilator settings are clinically appropriate before starting ventilation. Incorrect breathing circuit assembly and incorrect ventilator settings can injure the patient

Make sure that the preset alarm limits are appropriate for the patient before starting ventilation. Incorrect alarm settings can injure the patient.

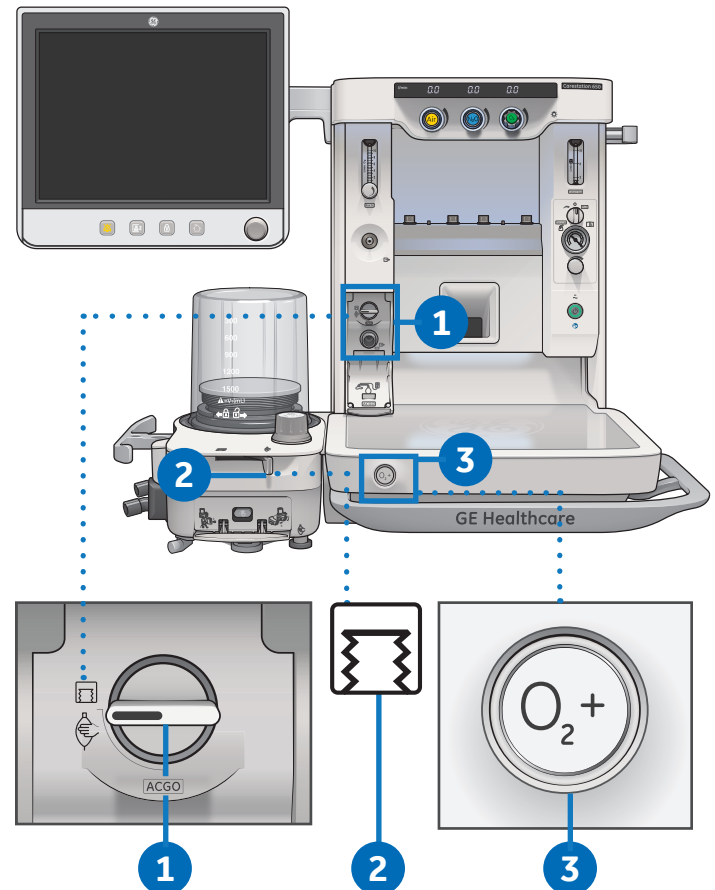



# Changing a Ventilator Mode and Setting

To change a vent mode:

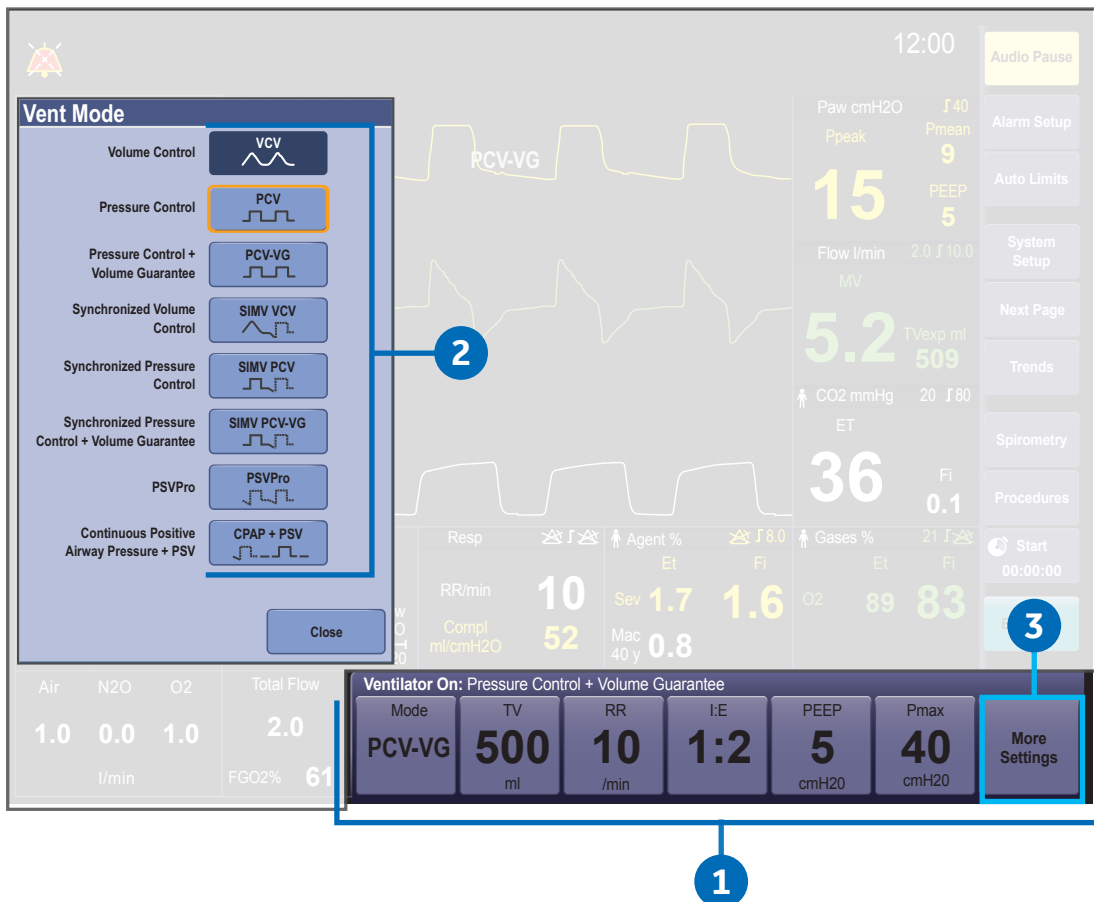

1. Select the **Mode** quick key. The Vent Mode menu shows.
2. Select the desired ventilation mode. Set and confirm the primary ventilation setting to activate the ventilation mode.
3. Controls that are frequently used in the ventilation mode can be adjusted with the ventilator quick keys and the **More Settings** quick key.

To change a ventilator setting: Select the ventilation setting to be adjusted. Set the desired value and then push the ComWheel to activate the change.



# 06 Alarms and Trends

## Setting Alarm Limits

The screenshot shows the 'Alarm Setup' screen for a ventilator in PCV-VG mode. The screen is divided into several sections:

- Primary Limits:** Contains settings for CO2 Alarms, Vol Apnea Alarm, and MV/TV Alarms, all set to 'On'. It also has a 'Low Limit' section with fields for Pmax (40), MV (2.0), EtCO2 (23), FIO2 (21), and FISev (Off).
- More Limits:** Contains a 'High Limit' section with fields for Pmax (10.0), MV (10.0), EtCO2 (60), FIO2 (Off), and FISev (8.0).
- Measured Value Fields:** A central area displaying various vital signs and alarm values, including Pmax (15), MV (5.2), CO2 (36), RR (10), Sev (1.7), Fi (1.6), O2 (89), and Fi (83).
- Buttons:** A vertical column of buttons on the right includes 'Alarm Setup' (1), 'Auto Limits' (2), 'System Setup', 'Next Page', 'Trends', 'Spirometry', 'Procedures', 'Start', and 'End Case'.
- Close Button:** A 'Close' button is located at the bottom of the 'Primary Limits' section (4).

1. Select **Alarm Setup** or...
2. Select one of the **Measured Value** fields
3. From the **Primary Limits** and **More Limits** tabs, select the alarm limit and make the change.
4. Push the Home key, touch the waveform area of the display, or select **Close** to close the menu



**Note:** Do not set alarm limits to extreme values. Setting limits to extreme values can render the alarm useless.

# Additional Alarm Settings

1. Use the **CO<sub>2</sub> Alarms** setting to turn off certain CO<sub>2</sub> alarms during manual ventilation.
2. Use the **Vol Apnea Alarm** setting to turn off the volume apnea alarm during manual ventilation. The volume apnea alarm remains off until the Bag/Vent switch is set to Vent or **Vol Apnea Alarm** is set to **On**.
3. Use the **MV/TV Alarms** setting to turn off the MV and TV alarms. Settings made during manual ventilation are not retained when mechanical ventilation starts. Settings made during mechanical ventilation are retained when manual ventilation starts.

 **Note:** The **Vol Apnea Alarm** will not be visible unless enabled in the Super User mode. **CO<sub>2</sub> Alarms** and **Vol Apnea Alarm** can only be turned off while in manual ventilation.

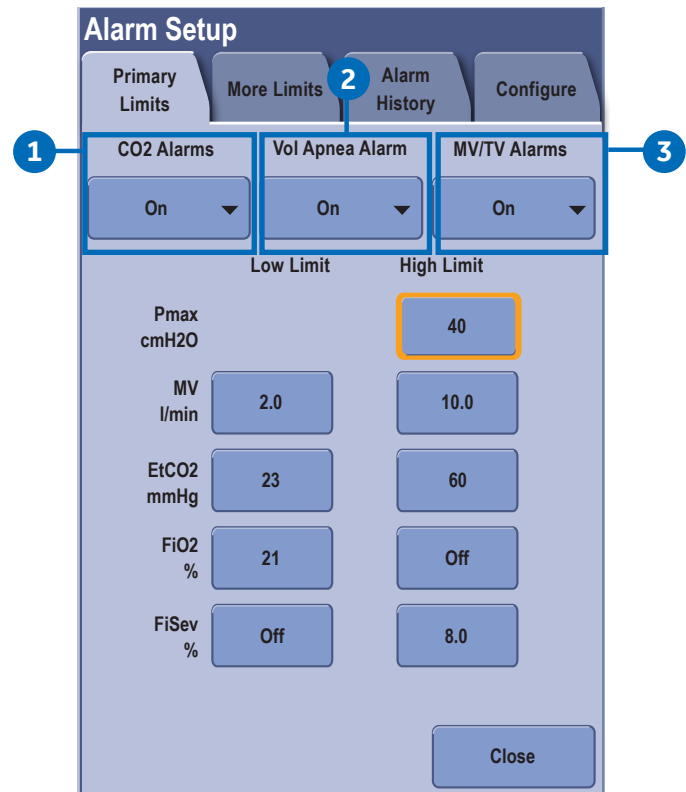

# Setting Auto Limits

Use the Auto Limits menu to quickly set alarm ranges for **MV**, **TV**, and **EtCO<sub>2</sub>** during mechanical ventilation.

1. Select **Auto Limits**. The menu shows the current measured values and the proposed low and high alarm limits. Check the proposed parameters and then:
2. Select **Confirm** to use the proposed low and high alarm limits.
3. Select **Cancel** to leave the alarm limits unchanged.
4. Select **Case Default Limits** to set the alarm limits to the case default limits.

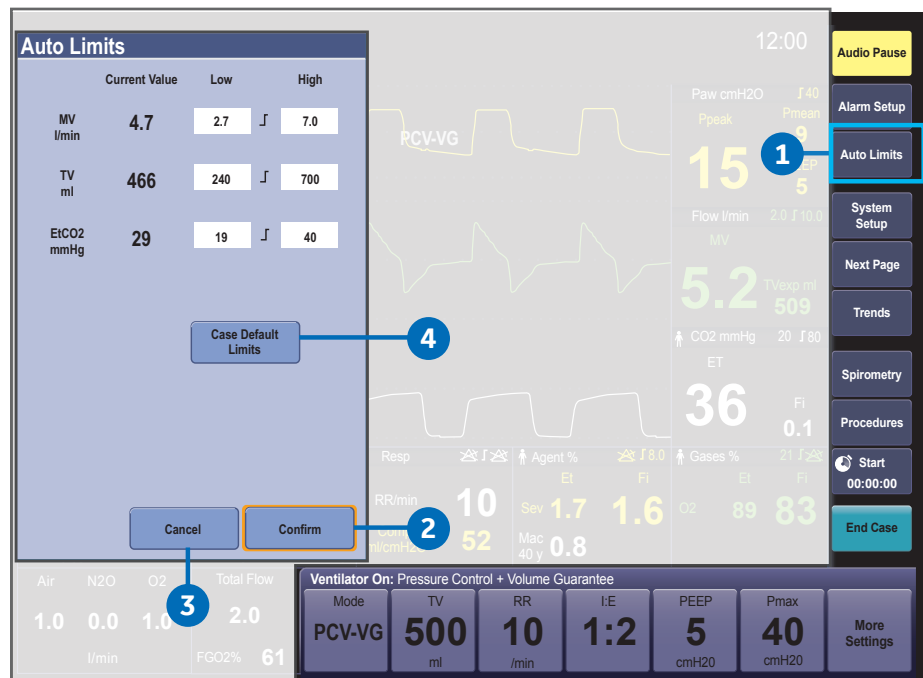

|                        | Current Value | Low | High |
|------------------------|---------------|-----|------|
| MV l/min               | 4.7           | 2.7 | 7.0  |
| TV ml                  | 466           | 240 | 700  |
| EtCO <sub>2</sub> mmHg | 29            | 19  | 40   |

# Viewing Trends

Use the Trends menu to view patient trends and set the time scale. There are three views for patient trends: Graphical, Measured (Numerical) and Settings. Trend information is saved every 15 seconds for the most recent 24 hours.

1. Select **Trends**.
2. Select the desired view.
3. Select **Scroll** to move through the current trend view.
4. Select **Time Scale** to select the desired scale from the dropdown menu.
5. Select **Next Page** to view additional parameters.
6. Select **Close**.

The screenshot shows the 'Trends' menu with the following elements:

- 1:** 'Trends' button in the right-hand navigation menu.
- 2:** 'View' menu containing 'Graphical', 'Measured', and 'Settings' options.
- 3:** 'Scroll' button.
- 4:** 'Time Scale' dropdown menu set to '1 h'.
- 5:** 'Next Page' button.
- 6:** 'Close' button.

The main display area shows 'Page 1 Measured Data' for '23-Sep-2015' with the following table:

| Time  | O2% Et/Fi | CO2 mmHg | AA % Et/Fi | AA ID | N2O% Et/Fi |
|-------|-----------|----------|------------|-------|------------|
| 13:20 | 90/90     | 0/0      | 0.0/0.0    |       | 0/0        |

Other visible data includes: Paw cmH2O (15), Ppeak (9), Pmean (5), Flow l/min (2.0), MV (5.2), TVexp ml (36), CO2 mmHg (1.7), O2 (1.6), and Gases % (89, 83). The ventilator settings at the bottom are: Mode PCV-VG, TV 500 ml, RR 10 /min, I:E 1:2, PEEP 5 cmH2O, Pmax 40 cmH2O.



# 07 Ventilation Modes

## Ventilation Modes Overview

The system has the following standard mode of mechanical ventilation:

- Volume control ventilation (VCV)

The system offers the following optional modes of mechanical ventilation:

- Pressure control ventilation (PCV)
- Pressure control ventilation - volume guaranteed (PCV-VG)
- Synchronized intermittent mandatory ventilation - volume control ventilation (SIMV VCV)
- Synchronized intermittent mandatory ventilation - pressure control ventilation (SIMV PCV)
- Synchronized intermittent mandatory ventilation - pressure control ventilation - volume guaranteed (SIMV PCV-VG)
- Pressure support ventilation with apnea backup (PSVPro™)
- Continuous positive airway pressure + pressure support ventilation (CPAP + PSV)

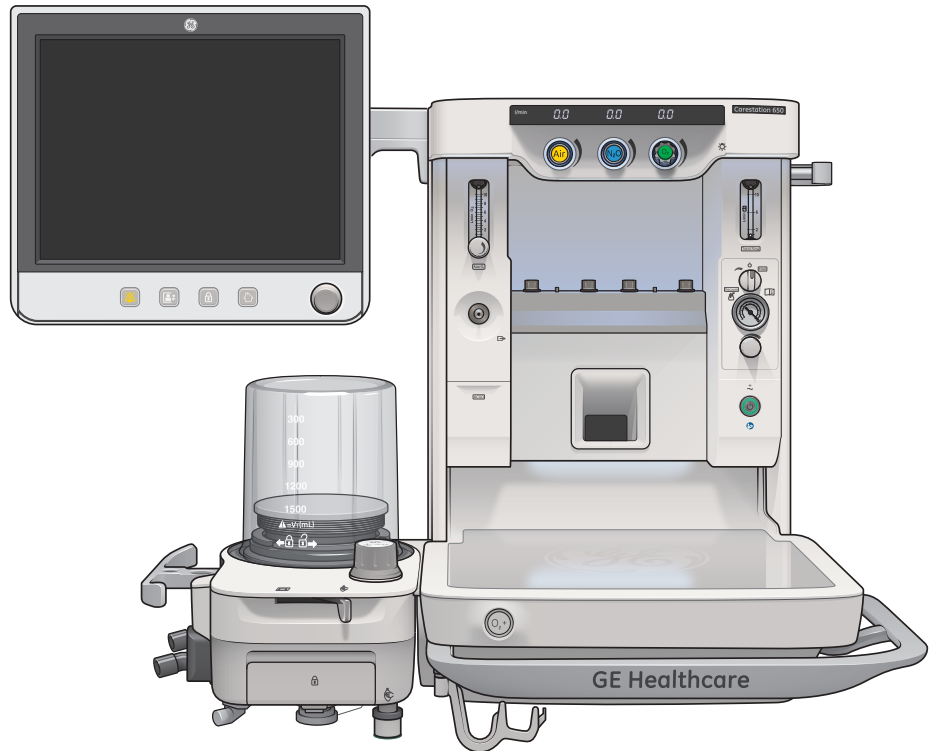

# VCV

## Volume control ventilation (VCV)

- Supplies a set volume to the patient
- Calculates a flow based on the set tidal volume and the length of the inspiratory time
- Can compensate for breathing system compliance, fresh gas flow, and moderate breathing system leaks
- Inspiratory pause is available

### VCV mode settings:

- TV
- RR
- I:E
- T<sub>pause</sub>
- PEEP
- P<sub>max</sub>

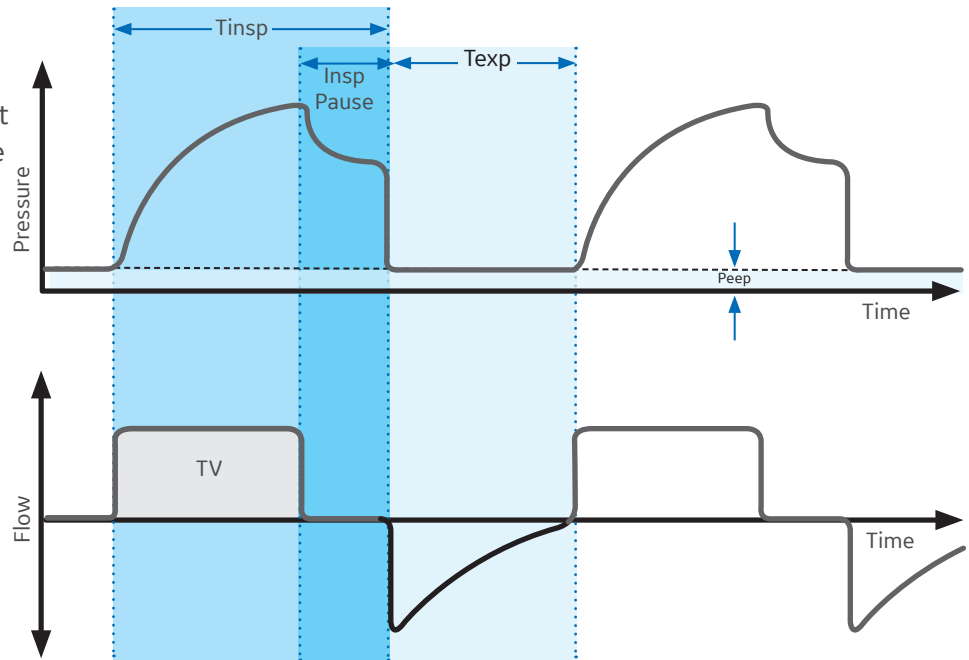

# PCV

## Pressure control ventilation (PCV)

- Supplies a constant set pressure during inspiration
- Inspiratory time is calculated from the rate and I:E settings
- High initial flow
- Flow is adjusted automatically to maintain set inspiratory pressure

### PCV mode settings:

- P<sub>insp</sub>
- RR
- I:E
- PEEP
- P<sub>max</sub>
- Rise Rate

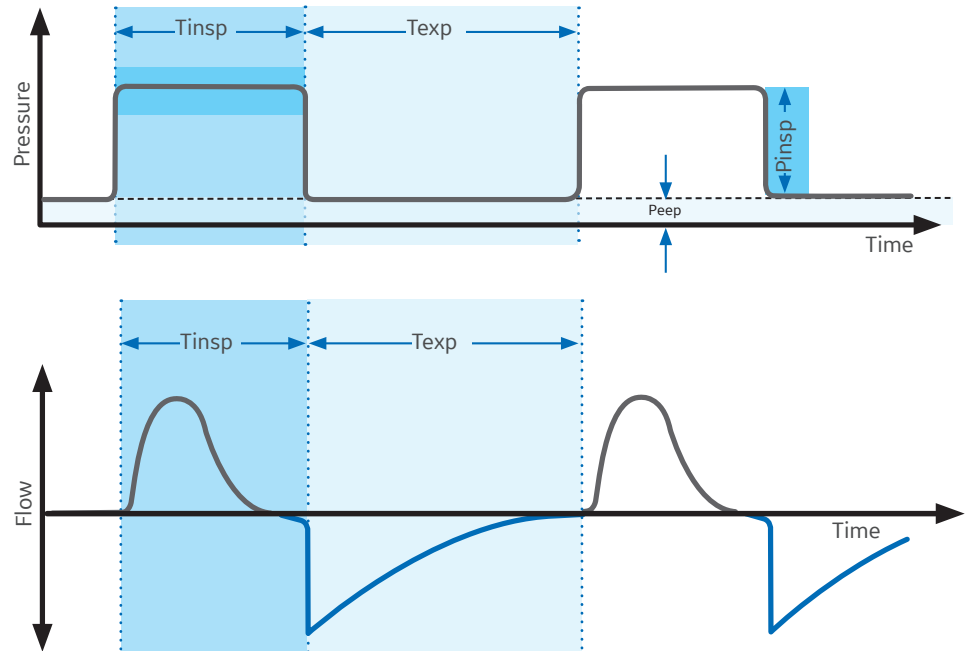



# PCV-VG

## Pressure control ventilation - volume guaranteed (PCV-VG)

- The first breath is a volume breath at set tidal volume
- Patient's compliance determined from this volume breath
- The inspiratory pressure level is then established for the next PCV-VG breath
- The ventilator will adjust the inspiratory pressure needed to deliver the set tidal volume breath-by-breath so that the lowest pressure is used

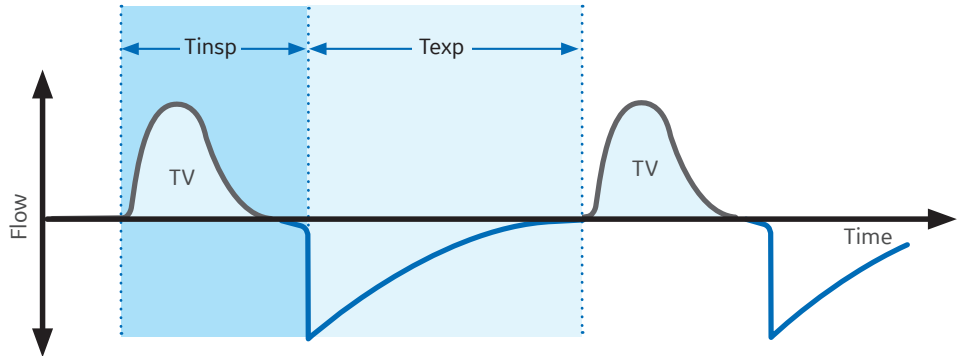
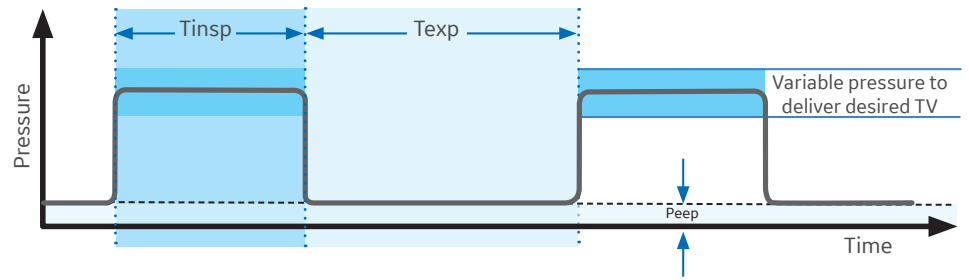

### PCV-VG mode settings:

- TV
- RR
- I:E
- PEEP
- Pmax
- Rise Rate

# SIMV VCV

## Synchronized intermittent mandatory ventilation - volume control ventilation (SIMV VCV)

- Periodic volume breaths are delivered at preset intervals
- Between the machine delivered breaths, the patient can breathe spontaneously
- Spontaneous breaths can be pressure supported
- Spontaneous breaths are indicated by a color change in the waveform

### SIMV-VCV mode settings:

- TV
- RR
- T<sub>insp</sub>
- T<sub>pause</sub>
- P<sub>support</sub>
- PEEP
- P<sub>max</sub>
- Trig Window
- Flow Trigger
- End of Breath
- Rise Rate

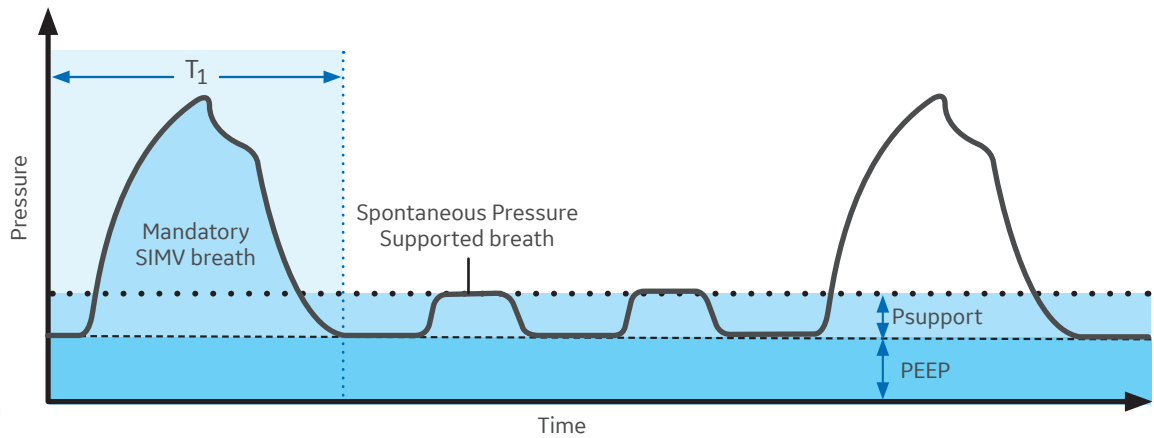

# SIMV PCV

Synchronized intermittent mandatory ventilation – pressure control ventilation (SIMV PCV)

- Delivers a relatively slow breathing rate with pressure controlled breathing
- Combines mandatory breaths with spontaneous breath support
- If a trigger event occurs within the synchronized window, a new pressure-controlled breath is initiated
- If a trigger event occurs elsewhere during the expiratory phase, a support for a spontaneous breath is provided with pressure support added as set by the clinician.

## SIMV PCV mode settings:

- P<sub>insp</sub>
- RR
- T<sub>insp</sub>
- P<sub>support</sub>
- PEEP
- P<sub>max</sub>
- Trig Window
- Flow Trigger
- End of Breath
- Rise Rate
- Exit Backup

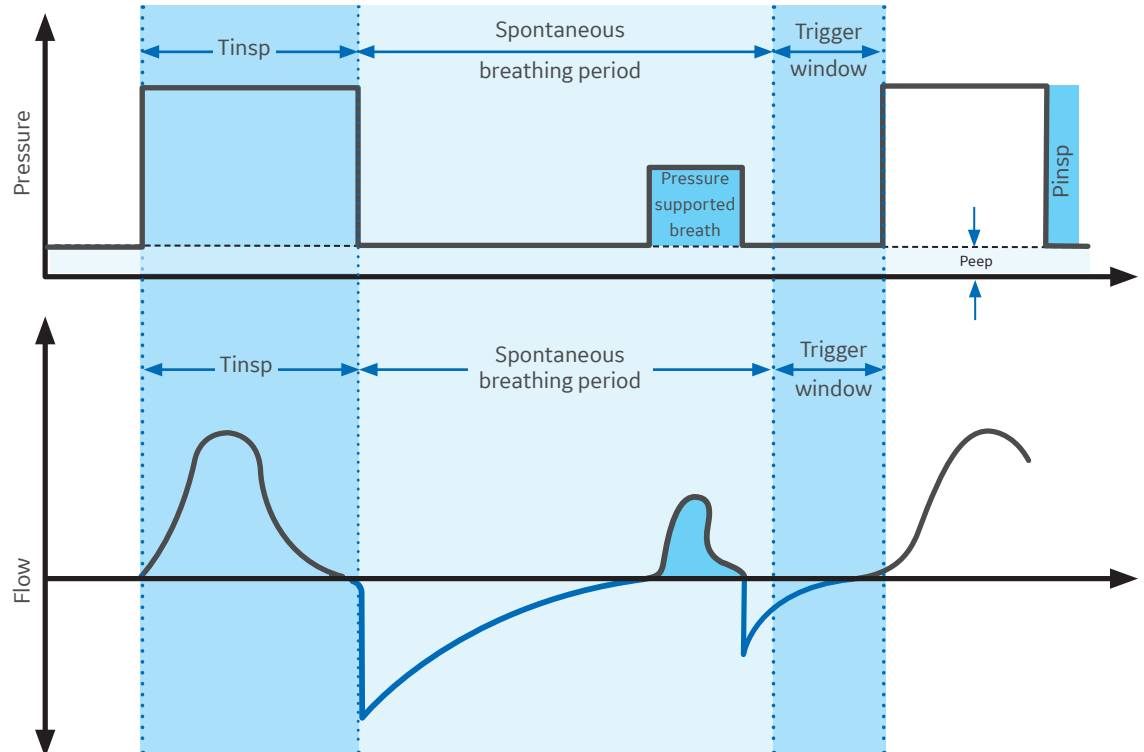

# SIMV PCV-VG

## Synchronized intermittent mandatory ventilation – pressure control ventilation - volume guaranteed (SIMV PCV-VG)

- Delivers a set rate of pressure controlled breaths with a guaranteed volume
- The ventilator will adjust the inspiratory pressure needed to deliver the set tidal volume breath-by-breath so that the lowest pressure is used.
- The patient's compliance is determined from the volume controlled ventilation breath and the inspiratory pressure level is then established for the next PCV-VG breath

### SIMV PCV-VG mode settings:

- TV
- RR
- Flow Trigger
- P<sub>support</sub>
- PEEP
- T<sub>insp</sub>
- P<sub>max</sub>
- Trig Window
- End of Breath
- Rise Rate
- PSV Rise Rate

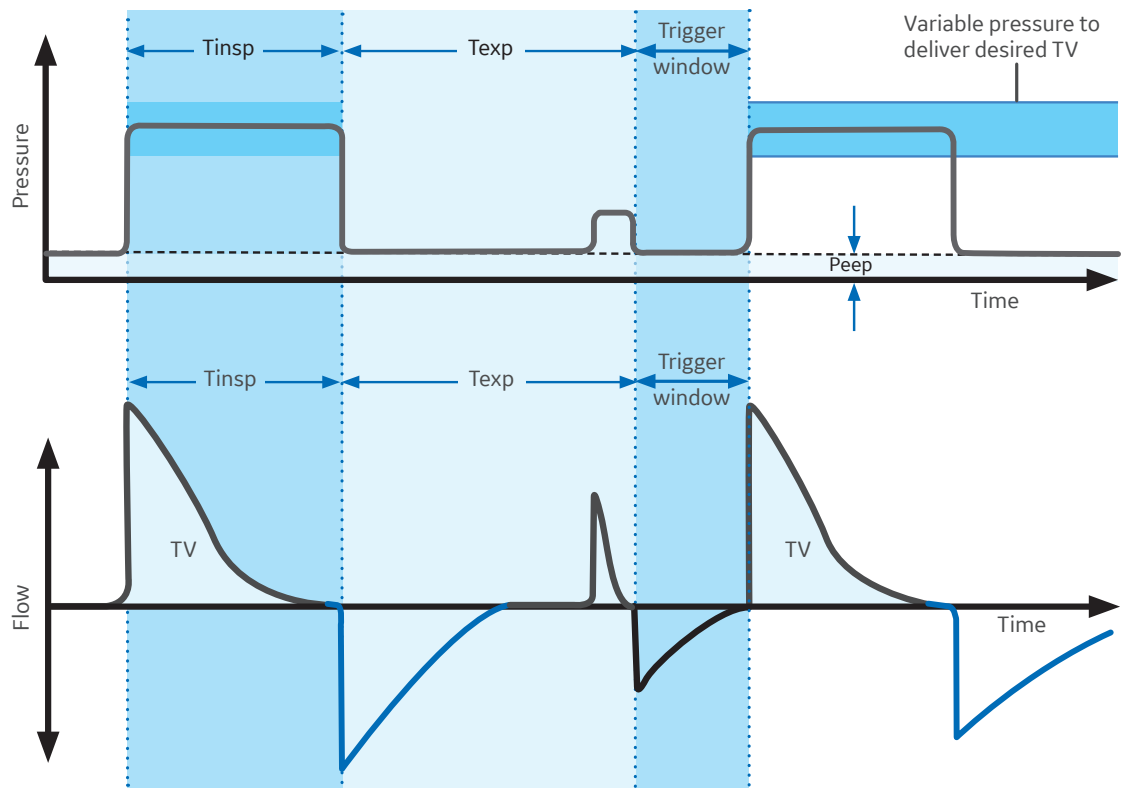

# PSVPro

## Pressure support ventilation with apnea backup (PSVPro)

- Pressure supported ventilation with apnea backup
- Clinician sets the P<sub>support</sub> and PEEP levels, the patient establishes the rate, inspiratory flow and inspiratory time
- Tidal volume is determined by the pressure, lung characteristics and patient effort
- Apnea backup mode (SIMV PCV) is provided if the patient stops breathing
- In backup mode, the Backup Mode active alarm is shown until PSVPro is reinstated or another ventilation mode is selected

### PSVPro mode settings:

- P<sub>support</sub>
- PEEP
- Trig Window
- Flow Trigger
- End of Breath
- P<sub>max</sub>
- Backup Time
- P<sub>insp</sub>
- RR
- T<sub>insp</sub>
- Rise Rate
- Exit Backup

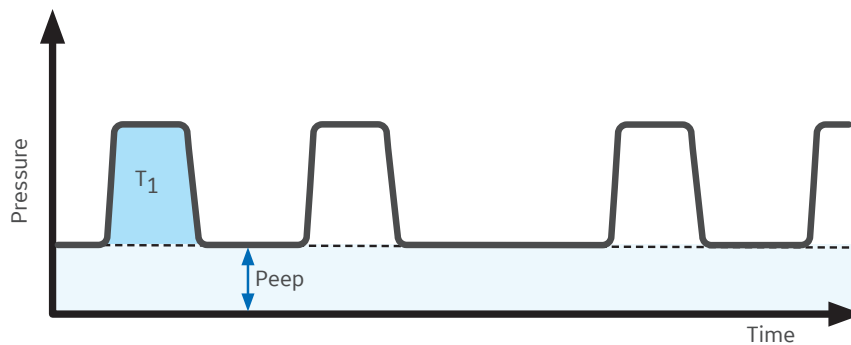

# CPAP + PSV

## Continuous positive airway pressure + pressure support ventilation (CPAP + PSV):

- Provides a constant support pressure for spontaneously breathing patients once the ventilator senses an inspiratory effort
- Spontaneous breaths that occur are indicated by a color change in the waveform

### CPAP + PSV settings:

- P<sub>support</sub>
- PEEP
- Flow Trigger
- End of Breath
- P<sub>max</sub>
- P<sub>insp</sub>
- Minimum RR
- T<sub>insp</sub>
- Rise Rate

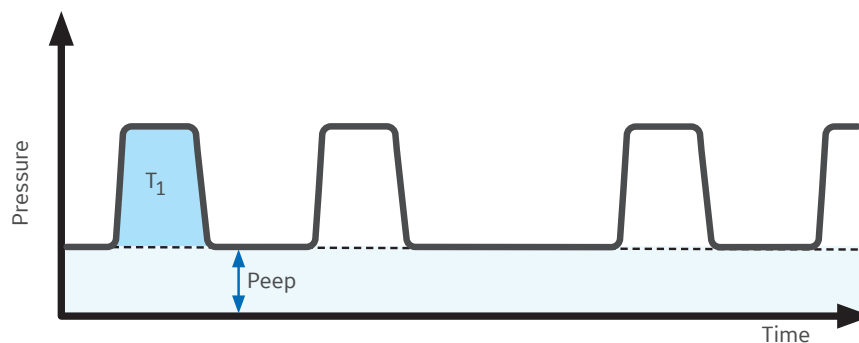



# 08 End Case and Standby

## Ending a Case

Use the End Case menu to end the patient alarms.

1. Set the Bag/Vent switch to **Bag**.
2. Turn off the gas flows.
3. Select **End Case**.
4. Select **End Case Now** on the menu to put the system in Standby (stops patient alarms). The **End Case** menu shows the gas and agent usage for the case.

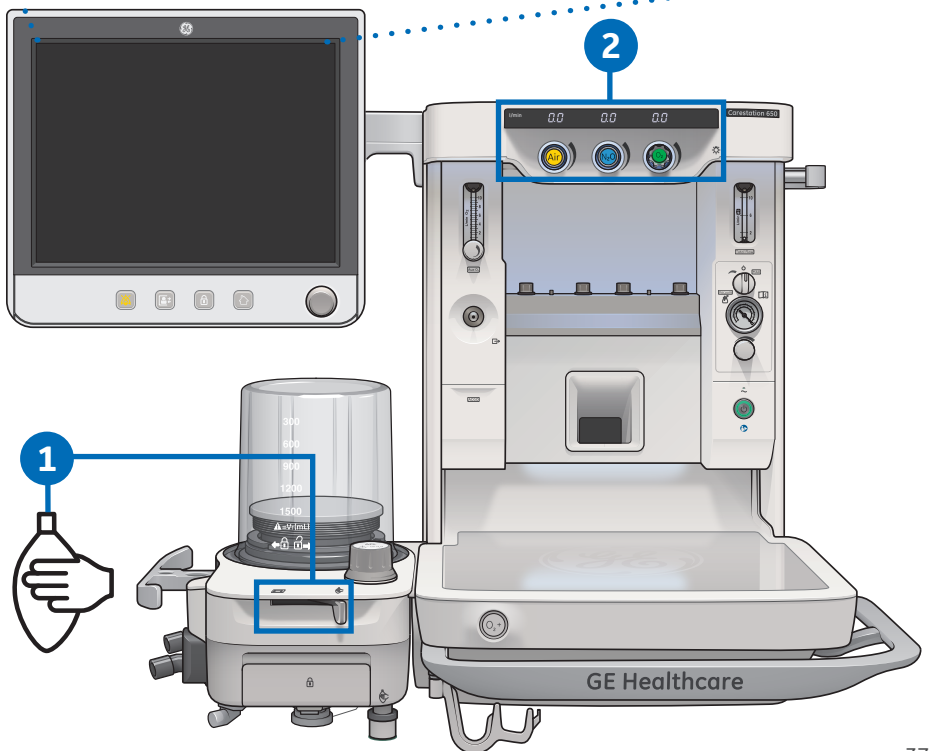
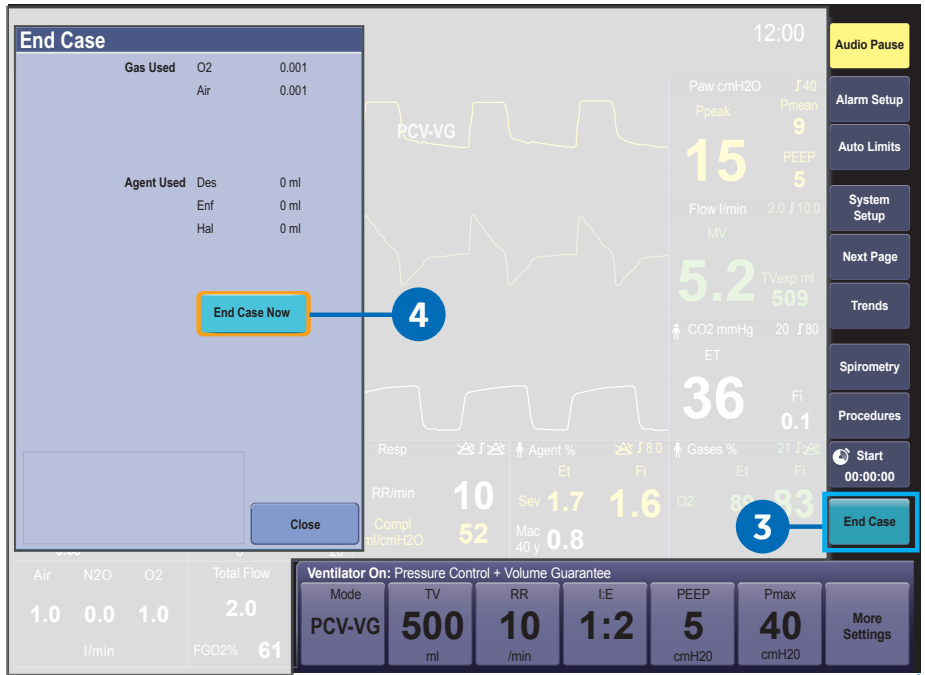

# Standby

When in Standby, most of the alarms are disabled. The Standby screen shows after End Case is selected.

If the fresh gas flow is more than 300 ml/min, a low priority alarm **Turn off gas flow** occurs reminding the user to turn off the fresh gas flow.

## From the Standby menu:

- A case can be started using the default settings by increasing the fresh gas flow, setting Bag/Vent switch to vent, turning on Aux O<sub>2</sub>+Air switch, or by turning on ACGO switch
- Select **System Setup** to open the System Setup menu
- Select **Checkout** to open the Checkout menu
- Select any other active function key to open the Start Case menu

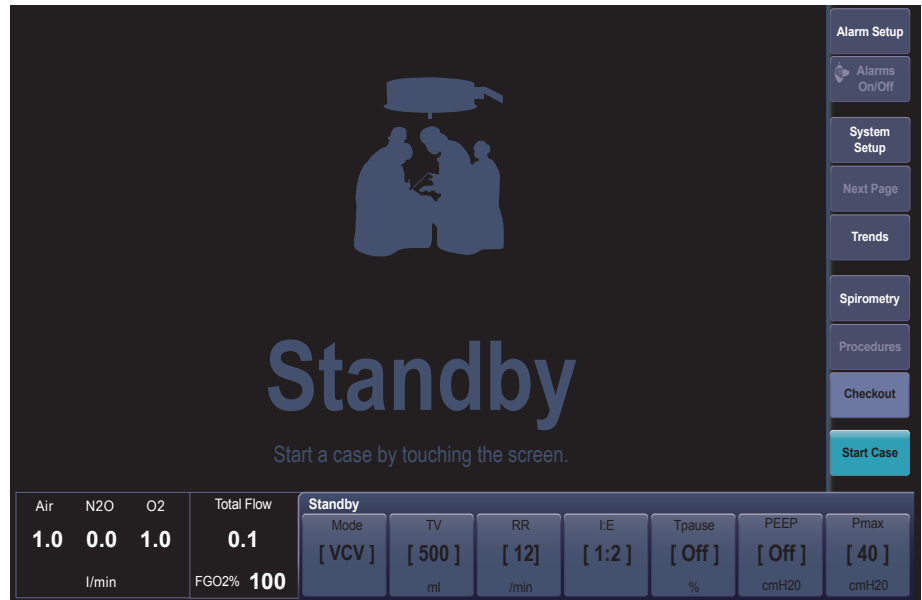

# Turning off the System

1. Perform the **End a case** procedure, if appropriate.
2. Push and hold the **On/Standby** switch for 1 second.
3. Select **Confirm** or push the ComWheel within 10 seconds to turn off the system.

If no action is performed within 10 seconds, the screen automatically returns to the previous display.

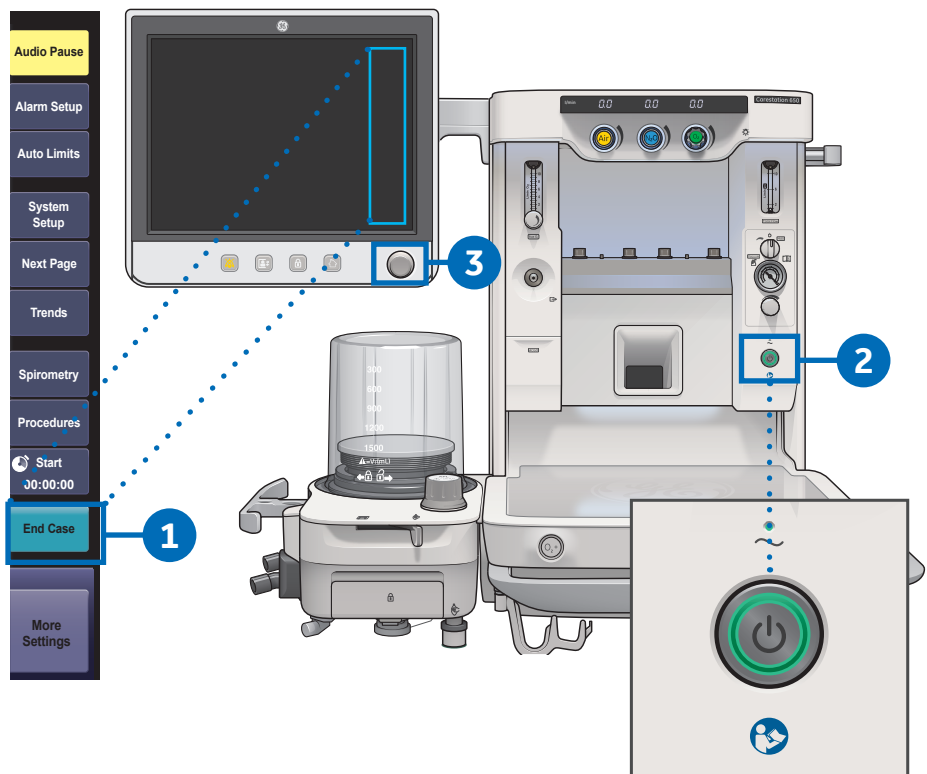



# 08 Checkout

## Checkout Overview

The Checkout menu shows on the display after turning on the system. To access the Checkout menu between cases, select Checkout. Step-by-step instructions show in the Checkout menu during the tests.

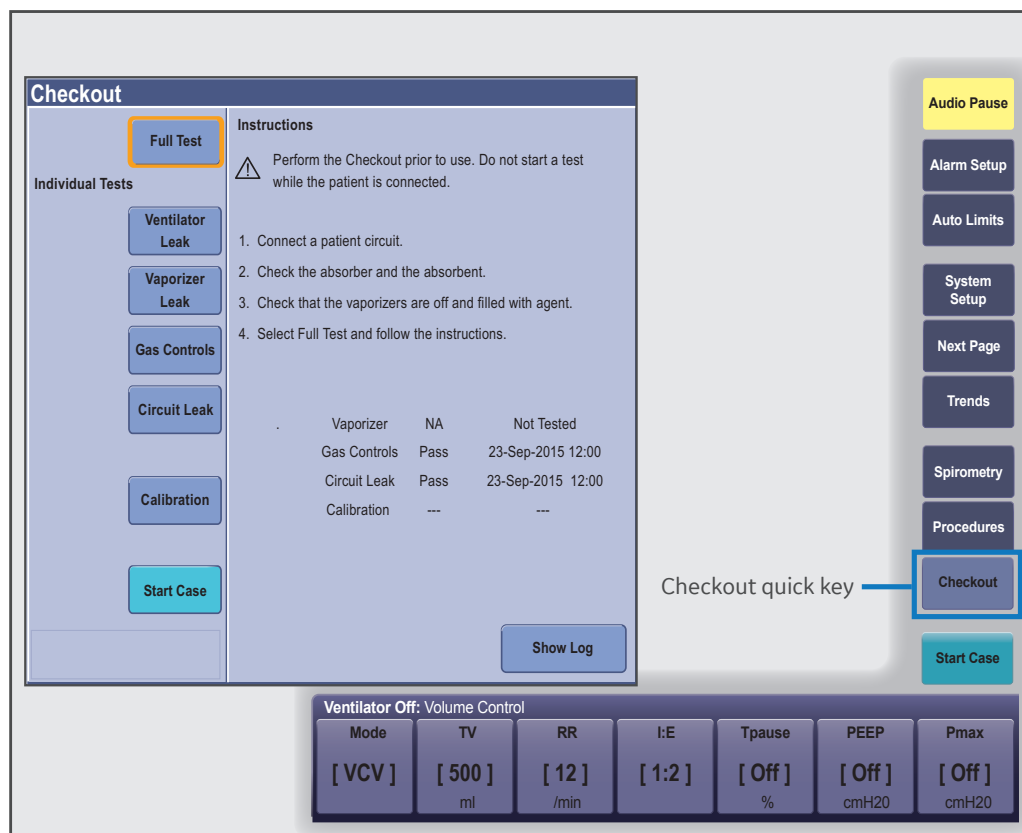

Use the Checkout menu to:

- Perform a Full Test
- Perform any of the individual tests
- View the Test Log
- Start a case

Perform the Full Test at the start of each day. The **Full Test** or all of the individual tests must be performed at least once within every 24-hour period.

# Checkout: Full Test

The Full Test runs automatically once selected and the color of the test indicator changes when the test is finished or if user action is required.

Perform a Full Test when any component of the system is changed (breathing system, vaporizers, pipeline inlets).

The Full Test does the following tests: Ventilator Leak, Vaporizer Leak, Gas Controls, and Circuit leak. When one of the tests is completed, the next test begins.

1. Select **Checkout**.
2. From the Checkout menu, select **Full Test** and follow the instructions.

If a test fails, follow the instructions to perform a retest or accept the results.

3. Before the test results are shown, a checklist is shown for confirmation. Numbers 1 through 6 are as shown.
4. Numbers 7 through 10 can be configured to match facility procedures by the Super User.

5. When the **Full Test** has completed the Checkout Test results will be displayed as shown.

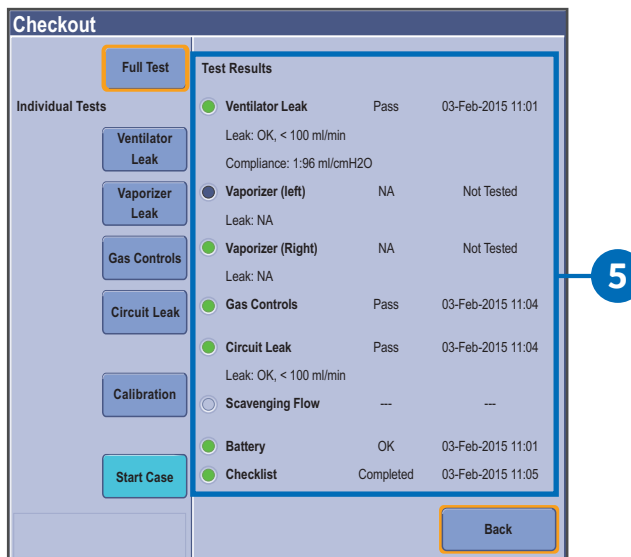
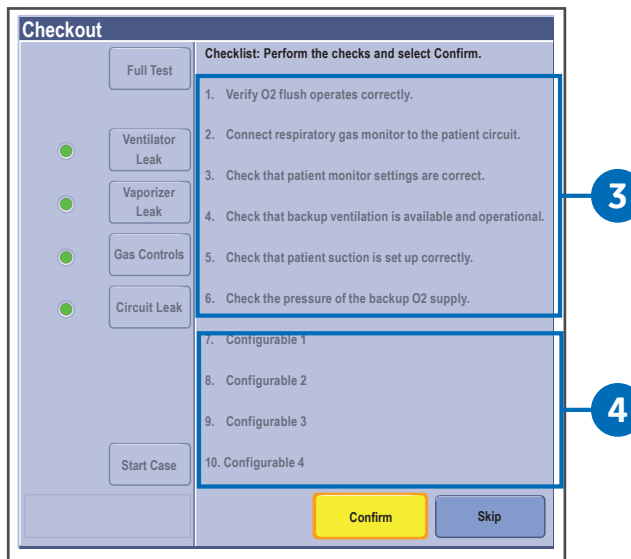
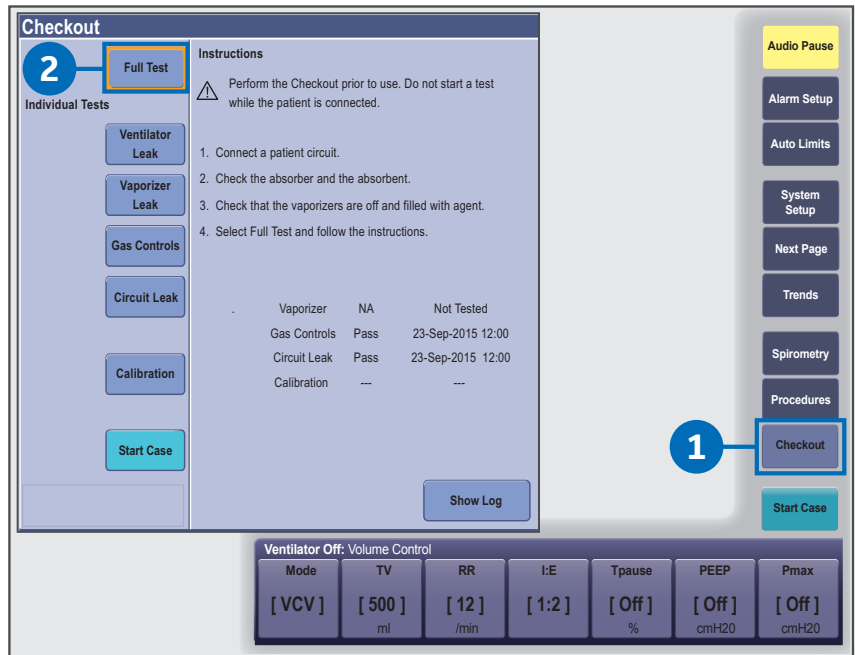

# 09 ecoFLOW

## Overview

The ecoFLOW option provides a split screen view that shows the approximate minimum O<sub>2</sub> flow to maintain a preset FiO<sub>2</sub> value. It also shows the approximate agent used per hour and the cost.

The split screen shows the Paw gauge in the upper area and the ecoFLOW gauge in the lower portion of the screen. The ecoFLOW gauge consists of a fresh gas flow tube, an agent flow indicator, and related parameters.

The fresh gas flow tube is a stacked flow tube showing the total O<sub>2</sub> flow on the bottom and the remaining gas (N<sub>2</sub> or N<sub>2</sub>O) on top. Below the fresh gas flow tube is the measured total O<sub>2</sub> flow to the patient and the calculated FiO<sub>2</sub> flow value. The FiO<sub>2</sub> flow value is based on the FiO<sub>2</sub> setting. This is the minimum O<sub>2</sub> flow needed to deliver a preset inspired O<sub>2</sub> concentration. The FiO<sub>2</sub> flow value is specific to each patient and case. It is calculated using the fresh gas settings, the patient O<sub>2</sub> uptake, the dilution effect of agent being delivered, and the effects of the circle breathing system.

The agent flow indicator shows the amount of liquid agent flow as related to the fresh gas setting. The calculated cost of the agent shows above this indicator. This cost is based on agent flow and the values entered in the **Agent Costs** menu set in **Super User** mode.

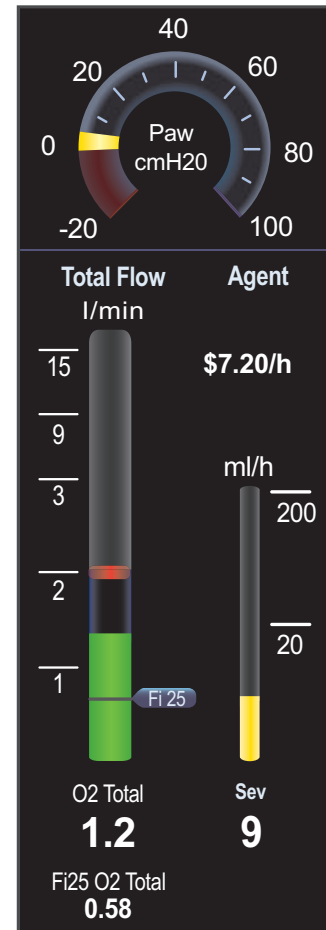

## Benefits of Low Flow Anesthesia

There are many benefits to reducing the amount of fresh gas flow in the operating room, including:

- Total FGF determines the amount of gas entering the scavenging system. Whenever FGF exceeds the patient's requirement, gases and vapors will enter the scavenging system and, ultimately, contaminate the atmosphere. By choosing minimal total FGF, the environmental impact of anesthetic vapors and gases can be minimized.<sup>1</sup>
- Anesthetic agents are the biggest ongoing expense associated with anesthesia units.<sup>2</sup>

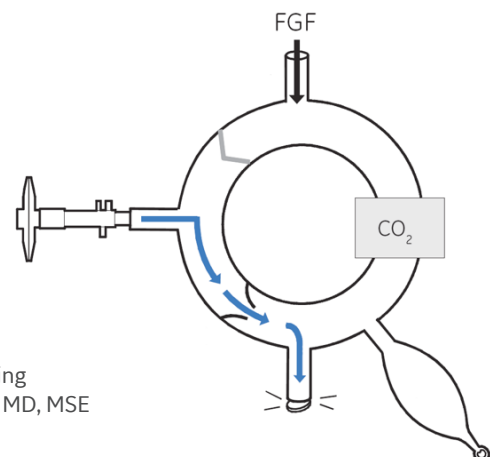

1. Source: "Greening the Operating Room: Reduce, Reuse, Recycle, and Redesign Managing Fresh Gas Flow to Reduce Environmental Contamination" Author: Jeffrey M. Feldman, MD, MSE  
2. Source: ECRI [https://www.ecri.org/ES/Documents/Anesthesia Units.pdf](https://www.ecri.org/ES/Documents/Anesthesia%20Units.pdf)

# Menu Components

- 1. Agent:** Shows Agent cost and flow information.
- 2. Agent Cost:** The cost of the current agent flow. This value is determined by the agent flow multiplied by the agent cost set in Super user mode.
- 3. Minimum O<sub>2</sub> Marker:** The graphical representation on the flow tube of the FiO<sub>2</sub> flow value. This marker can be removed by disabling it in Super user mode.
- 4. Agent Flow:** The measured value of the liquid agent flow from the vaporizer. The agent flow may have a delayed response. For example: Sev.
- 5. FiO<sub>2</sub> Flow:** The minimum O<sub>2</sub> flow needed to maintain the set inspired O<sub>2</sub> flow.



**Note!** This value is discussed in greater detail in the next section, **Understanding and Adjusting the Fi25\* O<sub>2</sub> Total.**

- 6. O<sub>2</sub> Total (numeric):** The numeric representation of the total O<sub>2</sub> flow. If N<sub>2</sub>O is the balance gas, this equals the set O<sub>2</sub> flow. If Air is the balance gas, this is the set O<sub>2</sub> flow plus 21% of the Air flow.
- 7. O<sub>2</sub> Total (graphical):** The graphical representation of the total O<sub>2</sub> flow. If N<sub>2</sub>O is the balance gas, this equals the set O<sub>2</sub> flow. If Air is the balance gas, this is the set O<sub>2</sub> flow plus 21% of the Air flow.
- 8. Remaining Gas Flow:** If N<sub>2</sub>O is the balance gas, this equals the set N<sub>2</sub>O flow. If Air is the balance gas, this N<sub>2</sub> is 79% of the Air flow.
- 9. Flow Bobbin:** The height of this represents the total fresh gas flow delivered to the breathing system.
- 10. Total Flow:** Shows Total Flow information.

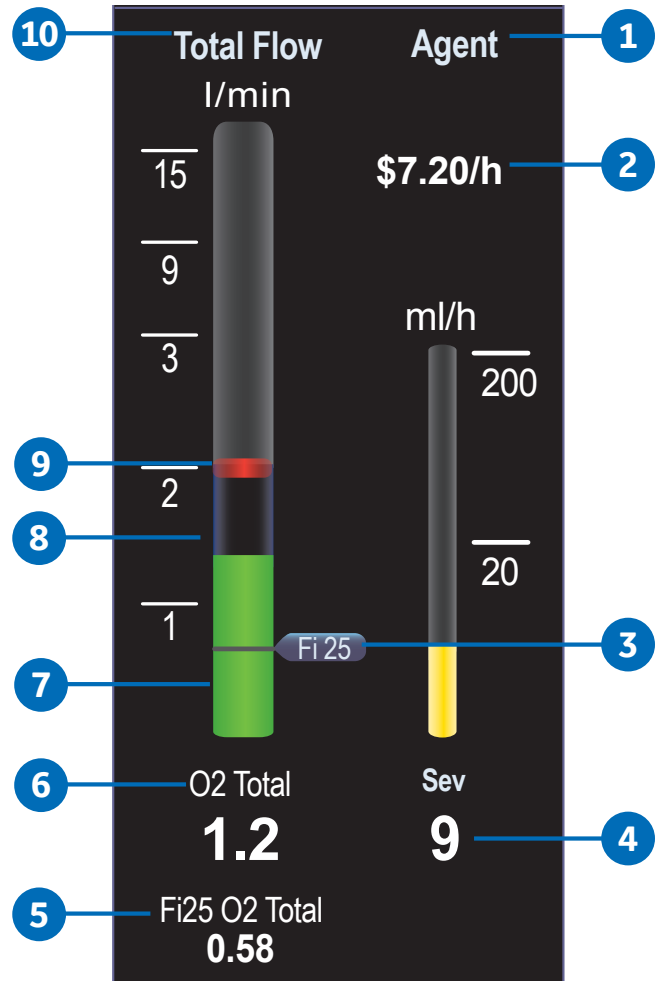

\*The minimum FiO<sub>2</sub> is shown as 25% for illustrative purposes. It can be set from 25% to 50% in the Super User menu that is password protected.

## Understanding and Adjusting the Fi25\* O<sub>2</sub> Total

In the EcoFLOW split screen, the **Fi25\* O<sub>2</sub> Total** value is displayed in the lower left corner below O<sub>2</sub> Total flow.

The Fi25\* O<sub>2</sub> Total indicates the lowest O<sub>2</sub> Flow needed within the Total Fresh Gas Flow (FGF) to maintain a minimal FiO<sub>2</sub> based upon the FiO<sub>2</sub> Flow Marker Value

To adjust the O<sub>2</sub> Flow within the total FGF to achieve the recommended **Fi25\* O<sub>2</sub> Total** value, select the O<sub>2</sub> (green) Fresh Gas Control knob located in the fresh gas controls on front of the machine and turn the O<sub>2</sub> control counter-clockwise to increase the flow and clockwise to decrease the flow. The O<sub>2</sub> fresh gas flow will be displayed on the LED display directly above the control knob. Adjust the O<sub>2</sub> flow per the recommended **Fi25 O<sub>2</sub>\* Total** flow recommendation in the ecoFLOW application.

The **Fi25\* O<sub>2</sub> Total** flow recommendation will adjust in increments. After your first initial change and depending on your starting point, the system will re-evaluate the minimal O<sub>2</sub> in the system and provide you with a new recommended **Fi25\* O<sub>2</sub> Total** value. You may need to readjust the O<sub>2</sub> Flow as your patient's demands change.



**Note!** When delivering 100% O<sub>2</sub>, the **Fi25\* O<sub>2</sub> Total** will match the total FGF. However, when delivering less than 100% O<sub>2</sub> in the system, it is important to adjust the O<sub>2</sub> flow within the FGF to match the recommended Fi25 O<sub>2</sub> Total. See examples below.

O<sub>2</sub> Fresh Gas Control knob. Adjust the O<sub>2</sub> flow within the FGF to match the recommended Fi25 O<sub>2</sub> flow value.



O<sub>2</sub> Fresh Gas Control knob. Adjust the O<sub>2</sub> flow within the FGF to match the recommended Fi25 O<sub>2</sub> flow value.

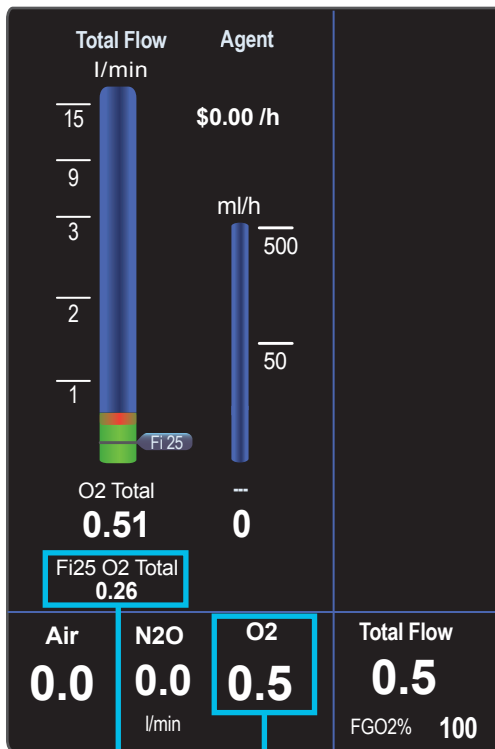

Recommended Fi25 O<sub>2</sub> Total flow. Adjust the O<sub>2</sub> Flow to match the recommended Fi25 O<sub>2</sub> flow value.

Digital display of the O<sub>2</sub> Flow.

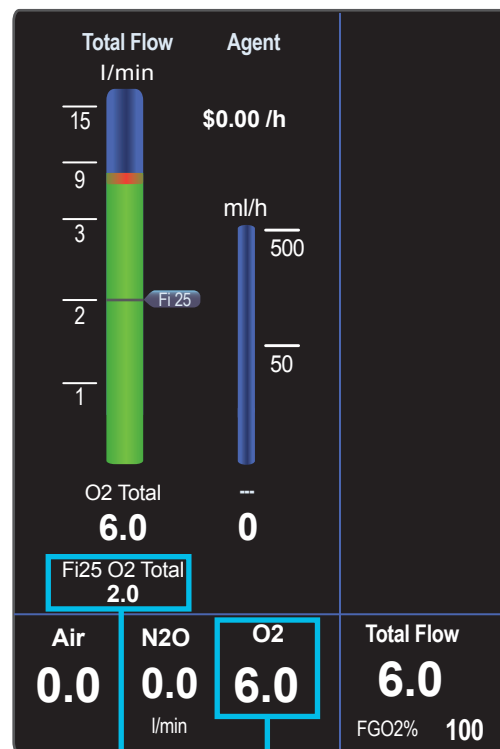

Recommended Fi25 O<sub>2</sub> Total flow. Adjust the O<sub>2</sub> Flow to match the recommended Fi25 O<sub>2</sub> flow value.

Digital display of the O<sub>2</sub> Flow.

\*The minimum FiO<sub>2</sub> is shown as 25% for illustrative purposes. It can be set from 25% to 50% in the Super User menu that is password protected.

# Activating the ecoFLOW Split Screen

1. Select **System Setup** > **Screen Setup**.

2. Select the **Layout** tab.

3. Select **Split Screen** and select **ecoFLOW** from the drop-down menu.

4. Select **Close**.

1. Select **System Setup** > **Screen Setup**.



**Note:** The Screen Setup menu can also be accessed by touching the split screen area.

2. Select the **Layout** tab.
3. Select **Split Screen** and select **ecoFLOW** from the drop-down menu.
4. Select **Close**.

# 10 Procedures

## Overview

Use the Procedures menu to pause the gas flow, start cardiac bypass, perform or change settings for a vital capacity procedure, or perform or change the settings for a cycling procedure.

- 1. Pause Gas Flow:** Temporarily suspends the flow of gas during a case.
- 2. Start Cardiac Bypass:** Suspends alarms for patients on cardiac bypass.
- 3. Vital Capacity:** Delivers a pressure breath for a set time.
- 4. Cycling:** Delivers pressure breaths through a series of ventilation steps.

The Vital Capacity and Cycling procedures will only show if they have been enabled in the Super User mode.

More information about each procedure will be discussed in the following chapters.



**Note:** PEEP and TV settings can be changed after entering cardiac bypass mode.

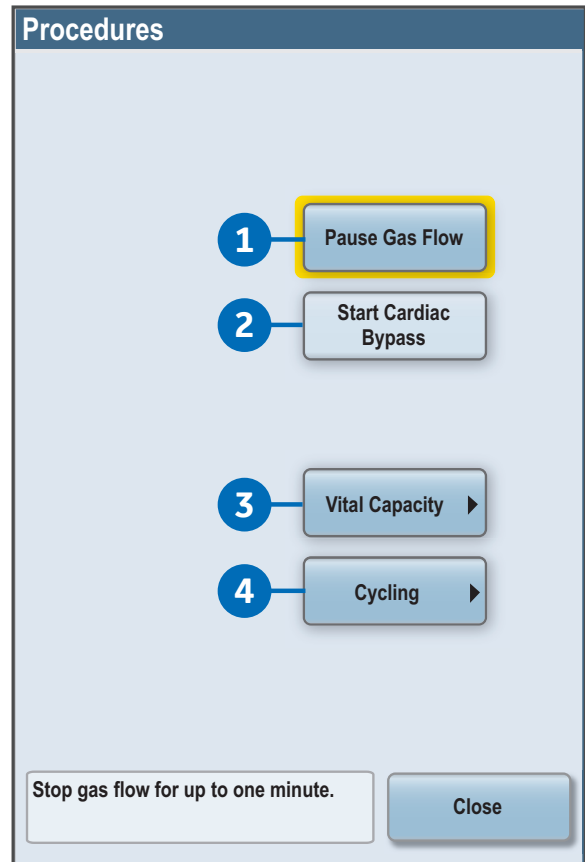

# Pause Gas Flow

Use **Pause Gas Flow** to temporarily suspend the flow of gas during a case. Using **Pause Gas Flow** while the breathing circuit is disconnected prevents the flow of gas into the room. **Pause Gas Flow** is available during both mechanical ventilation and manual ventilation.

The screenshot displays the ventilator control interface during a gas flow pause. The 'Flow Paused 0:58' window is prominent on the left. The 'Restart Gas Flow' button is highlighted with a yellow box and a blue circle labeled '2'. The 'Procedures' button on the right sidebar is highlighted with a blue box and a blue circle labeled '1'. The bottom control panel shows settings for PCV-VG mode, TV 500 ml, RR 10 /min, I:E 1:2, PEEP 5 cmH2O, and Pmax 40 cmH2O. The top right shows a clock at 12:00 and an 'Audio Pause' button. The central display shows Ppeak 15, Pmean 9, PEEP 5, Flow 5.2 l/min, TVexp 509 ml, CO2 36 mmHg, and FiO2 0.8. The bottom left shows gas flow settings: Air 1.0 l/min, N2O 0.0 l/min, O2 1.0 l/min, Total Flow 2.0 l/min, FGO2% 61. A 'Close' button is at the bottom of the 'Flow Paused' window.

1. Select **Procedures** from the right side of the display.
2. Select **Pause Gas Flow**. Once **Pause Gas Flow** is selected, then selection will change to **Restart Gas Flow**.
  - The amount of time remaining in the gas flow pause shows in the window.
  - Gas flow stops for 1 minute and automatically resumes after 1 minute.
  - If mechanical ventilation is on, mechanical ventilation stops for 1 minute and then automatically resumes after 1 minute.
3. Resume the flow of gas at any time during the pause by selecting **Restart Gas Flow**.



**Note:** Select **Procedures** from the right side of the display to initiate any of the procedures discussed in this section.



# Cardiac Bypass

There are two types of cardiac bypass. Manual ventilation cardiac bypass is standard. VCV cardiac bypass is optional.

Manual ventilation cardiac bypass suspends alarms for patients on cardiac bypass when the ventilator is not mechanically ventilating. The volume, apnea, low agent, CO<sub>2</sub>, and respiratory rate alarms are suspended. The alarms are enabled when cardiac bypass is turned off or mechanical ventilation is started.

Systems with the VCV cardiac bypass option enabled can mechanically ventilate while in VCV mode. The VCV mode is the only ventilation mode available while using VCV cardiac bypass. The volume, apnea, low agent, CO<sub>2</sub>, low Paw, and respiratory rate alarms are suspended. The alarms are enabled when VCV cardiac bypass is turned off or mechanical ventilation is stopped.

## Using Manual Ventilation Cardiac Bypass:

1. Set the Bag/Vent switch to **Bag**.
2. Select **Procedures**.
3. Select **Start Cardiac Bypass**. The Cardiac Bypass message shows in the waveforms and in the general message field when manual ventilation cardiac bypass is active.
4. Select **Close**.

## Using VCV Cardiac Bypass:

1. Start mechanical ventilation in **VCV** mode.
2. Select **Procedures**.
3. Select **Start Cardiac Bypass**.
  - PEEP is set to 5 cmH<sub>2</sub>O
  - TV settings of less than 170 ml prior to starting cardiac bypass remain at the set TV
  - TV settings of more than 170 ml prior to starting cardiac bypass change to 170 ml
  - The VCV Cardiac Bypass message shows in the waveforms and in the general message field when VCV cardiac bypass is active
4. Select **Close**.



**Note:** PEEP and TV settings can be changed after entering cardiac bypass mode.

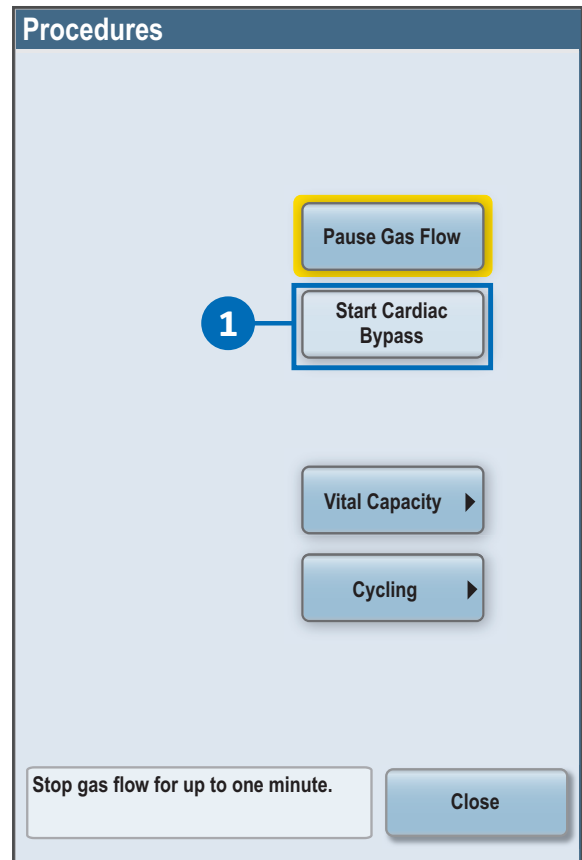

# Vital Capacity

Use the Vital Capacity procedure to deliver a pressure breath for a set time. The Vital Capacity procedure provides a simple way to deliver one pressure breath during mechanical ventilation without making multiple ventilator setting changes. The **PEEP on Exit** setting provides a way to change the ventilation PEEP setting automatically at the end of the Vital Capacity procedure.

The **Pressure Hold**, **Hold Time**, and **PEEP on Exit** settings can be preset by the Super User. These settings can be changed by the user before starting the procedure. The **PEEP on Exit** setting only shows if it has been enabled in the Super User mode.

## Using vital capacity:

1. Select **Procedures**.
2. Select **Start Vital Capacity**.
  - One pressure breath is given at the set pressure.
  - The pressure is held for the set time.
  - PEEP is set to the **PEEP on Exit** setting. If the procedure is stopped before completion, the PEEP on Exit setting is not used
3. Select **Stop Vital Capacity** at any time to stop the procedure.
4. Select **Close**.

## Changing vital capacity settings:

1. Select **Procedures**.
2. Select the setting to change and make the change.
  - Set **Pressure Hold** to between 20 and 60 cmH<sub>2</sub>O.
  - Set **Hold Time** to between 10 and 40 seconds.
  - Set **PEEP on Exit** to Off or between 4 and 30 cmH<sub>2</sub>O.
3. Select **Start Vital Capacity**.
4. Select **Close**.



**Note:** The Vital Capacity procedure will only show if it has been enabled in the Super User mode.

**Vital Capacity**

Start Vital Capacity

Pressure Hold cmH<sub>2</sub>O 35

Hold Time s 15

PEEP on Exit cmH<sub>2</sub>O 4

Turn on mechanical ventilation. Then select Start.

Close

# Cycling

Use the Cycling procedure to deliver pressure breaths through a series of ventilation steps. The Cycling procedure provides a flexible way to deliver pressure breaths during ventilation without making multiple ventilator setting changes. Up to seven preset steps with multiple breaths are available.



**Note:** *There is a limited amount of gas in the bellows. No additional gas enters the bellows during the cycling procedure. Increase fresh gas flow to avoid bellows collapse.*

Each procedure defaults steps and ventilation settings which can be preset by the Super User. The ventilation settings of each step can be changed by the user before starting a procedure.

## Using cycling:

1. Select **Procedures**.
2. Select **Cycling**.
3. Select a **Procedure** to perform.
4. Select **Start Cycling**.
  - The procedure begins.
  - Procedure progress shows in the procedure window.
5. Stop the procedure anytime by selecting **Stop Cycling**.
6. Select **Close**.

## Changing cycling settings:

1. Select **Procedures**.
2. Select **Cycling**.
3. Select a **Procedure** to perform.
4. Select **Adjust Settings**. The first setting of Step 1 in the procedure window is selected.
5. Push the ComWheel to enter the adjustment window.
6. Use the ComWheel to navigate the adjustment window and change a value.
7. Select **Start Cycling**.
8. Select **Close**.



**Note:** *The Cycling procedure will only show if it has been enabled in the Super User mode.*

| Step              | 1   | 2   | 3   | 4   | 5   | 6   | 7   |
|-------------------|-----|-----|-----|-----|-----|-----|-----|
| P <sub>insp</sub> | 10  | 10  | 10  | 10  | 10  | 10  | 10  |
| PEEP              | 2   | 4   | 6   | 8   | 6   | 4   | 2   |
| Breaths           | 3   | 3   | 3   | 5   | 3   | 3   | 3   |
| I:E               | 1:2 | 1:2 | 1:2 | 1:1 | 1:2 | 1:2 | 1:2 |
| RR                | 10  | 10  | 10  | 10  | 10  | 10  | 10  |



# 11 Spirometry

## Overview

### Use the Spirometry menu to:

- Set the loop type
- Adjust the loop scaling
- Save a loop to memory
- Access the Setup Loops menu
- View a saved loop
- Delete a saved loop

### Spirometry Loops:

There are three types of spirometry loops:

1. Pressure-Volume (Paw-Vol)
2. Flow-Volume (Flow-Vol)
3. Pressure-Flow (Paw-Flow).

The spirometry loops show in the spirometry window and can be set to show alongside the waveforms as the split screen.

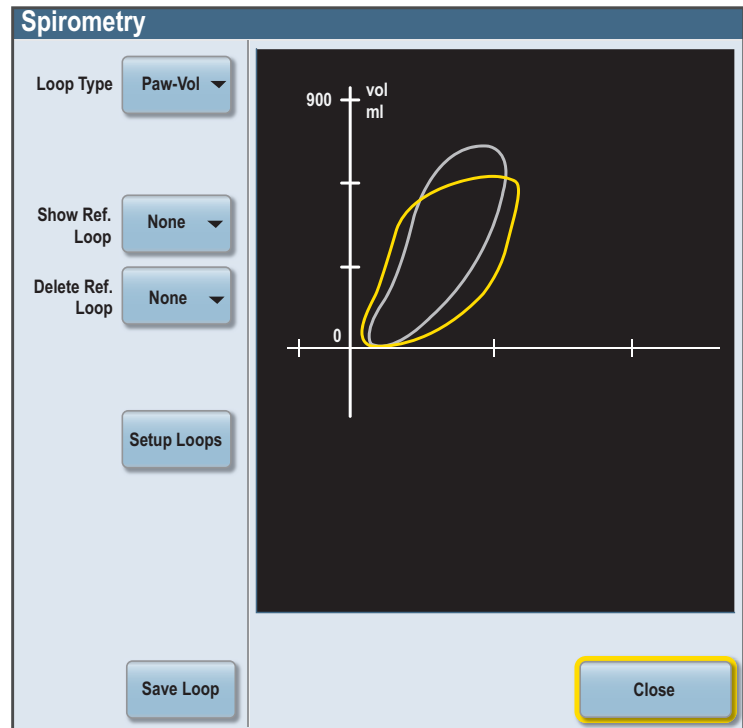

### Spirometry loop components:

1. Volume axis
2. Pressure axis
3. Real-time loop
4. Reference loop (appears on display in gray)

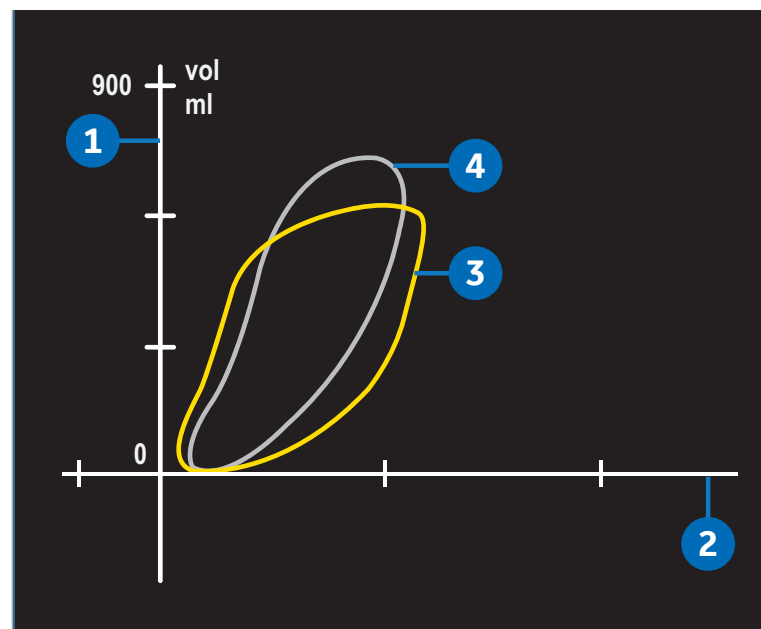

# Setting a Spirometry Loop type

## Setting the Loop Type:

1. Select **Spirometry** from the right side of the display.
2. Select **Loop Type** and select the loop from the drop-down list.
3. Select **Close**.

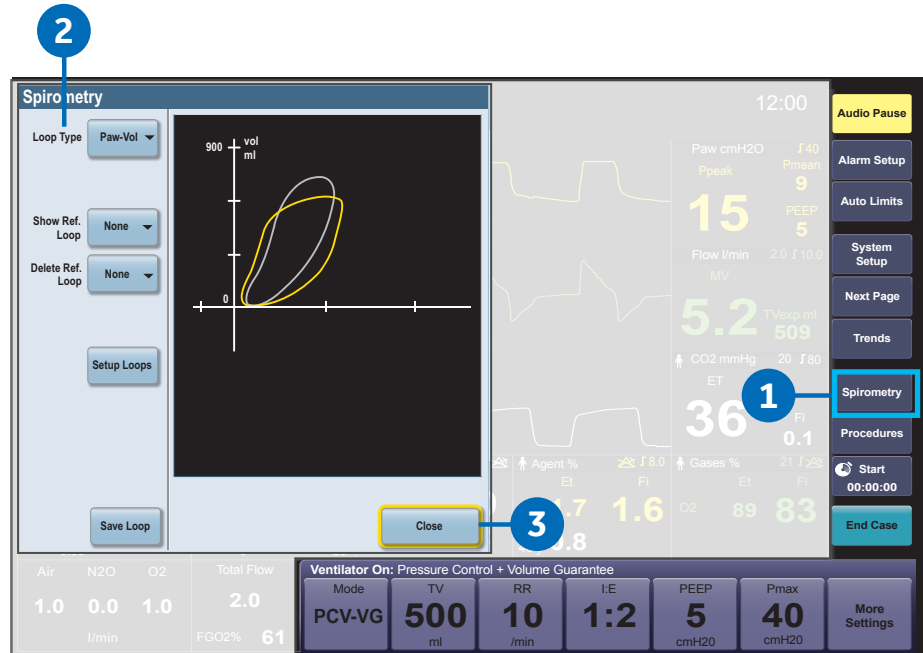

# Setting Loop Graph Scaling

Use Spirometry Scaling to set the scales of the spirometry loop graph. The available settings for the volume, Paw, and flow graph axes are dependent on the set patient type of adult or pediatric.

- **Auto** automatically adjusts the volume, Paw, and flow axes of the loop based on the minimum and maximum breath reading shown in the waveform.
- **Linked** links the adjustment of the volume, Paw, and flow axes of the loop graph together. Change one of the scales and the remaining two scales automatically change based on the one set scale.
- **Indep.** allows the axes of the loop graph to be changed separately for the volume, Paw, and flow axes.

1. Select **Spirometry**.
2. Select **Setup Loops**.
3. Select **Spirometry Scaling** and set the scale type from the drop-down list.
4. Select **Back** to view changes made and access other functions of the Spirometry menu.

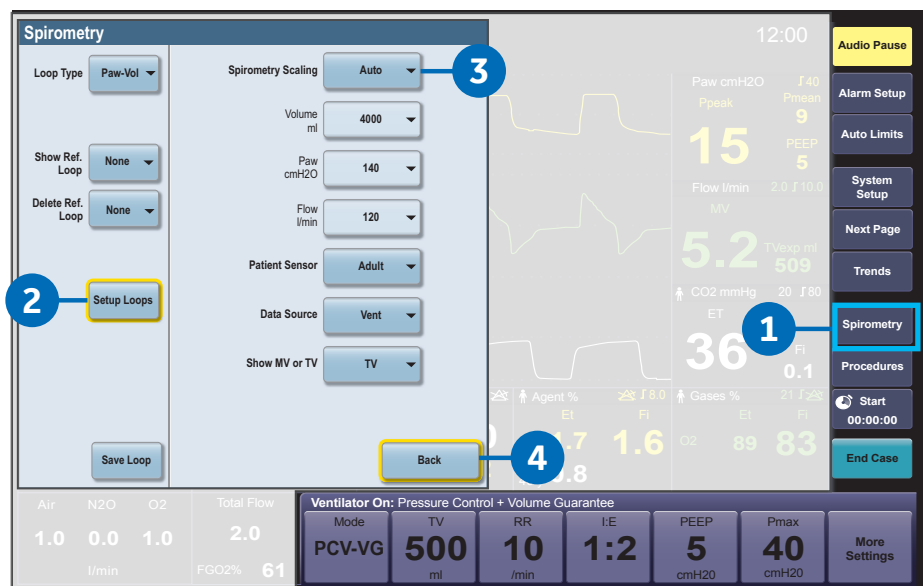

# Setting the Data Source

Use Data Source to specify the source of spirometry data.

1. Select **Spirometry**.
2. Select **Setup Loops**.
  - This menu can also be accessed by selecting **System Setup > Screen Setup > More Settings**.
3. Select **Data Source**. Select Patient to have spirometry data sourced from the airway module or **Vent** to have spirometry data sourced from the ventilator. When using an airway module without spirometry, only **Vent** is available for the **Data Source**.
4. Select **Back** to view changes made and access other functions of the Spirometry menu.

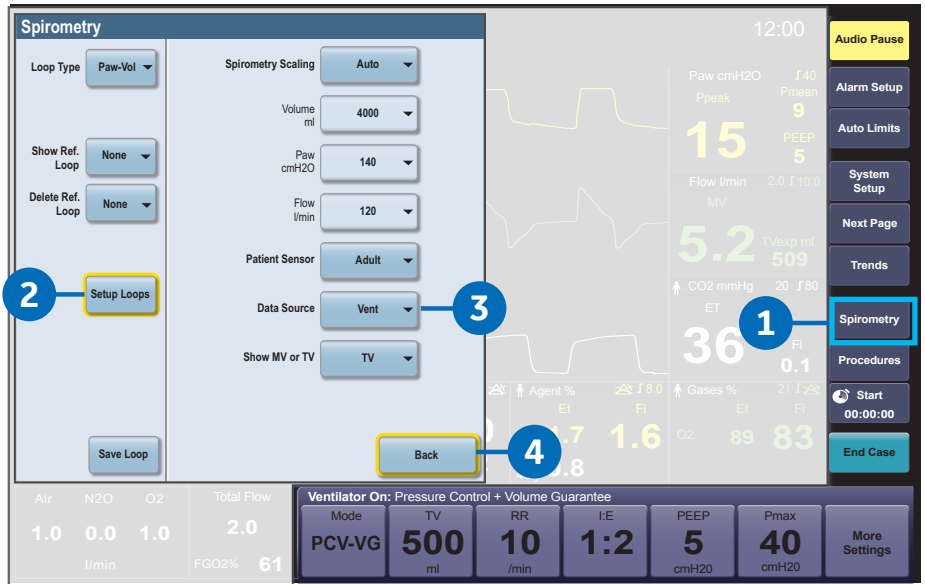

**Note:** The Cycling procedure will only show if it has been enabled in the Super User mode. If no airway module is installed, all settings will default back to Vent.

# Setting Patient and Sensor Type

Patient and sensor type refer to the style of airway adapter used with the airway module. If spirometry data is obtained from the airway module, make sure that the sensor type matches the type of airway adapter used. Adult or pediatric patient types are available.

1. Select **Spirometry**.
2. Select **Setup Loops**.
3. Select **Patient and Sensor** and then select **Adult** or **Pedi** depending on the sensor used.
4. Select **Back** to view changes made and access other functions of the Spirometry menu.



**Note:** The Cycling procedure will only show if it has been enabled in the Super User mode. If no airway module is installed, all settings will default back to Vent.

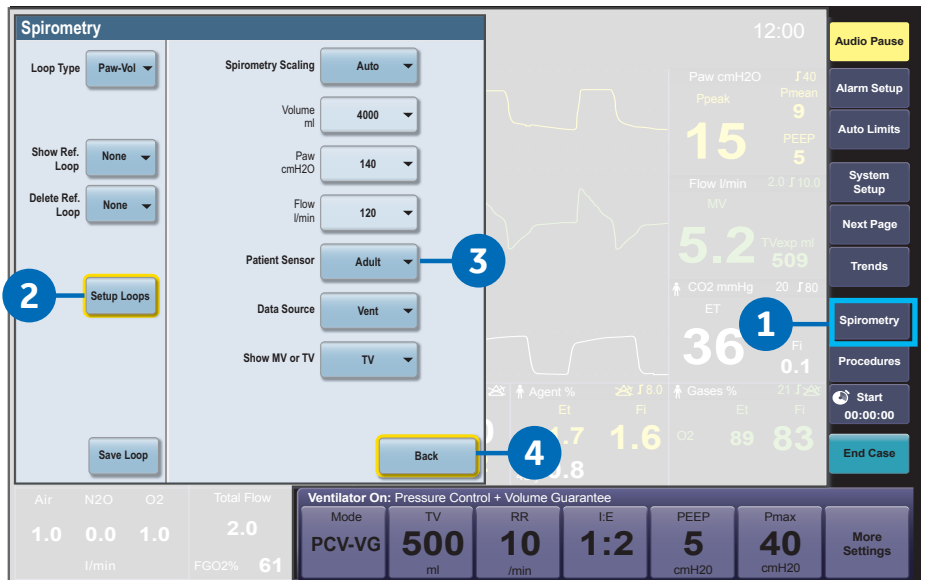

# Changing Spirometry Volume type

The volume shown on the spirometry split screen can be set to minute volume or tidal volume.

1. Select **Spirometry**.
2. Select **Setup Loops**.
3. Select **Show MV** or **TV** and select **MV** or **TV** from the dropdown list.
  - Set to **TV** to show TVinsp and TVexp on the spirometry split screen.
  - Set to **MV** to show MVexp and TVexp on the spirometry split screen.
4. Select **Back** to view changes made and access other functions of the **Spirometry** menu.

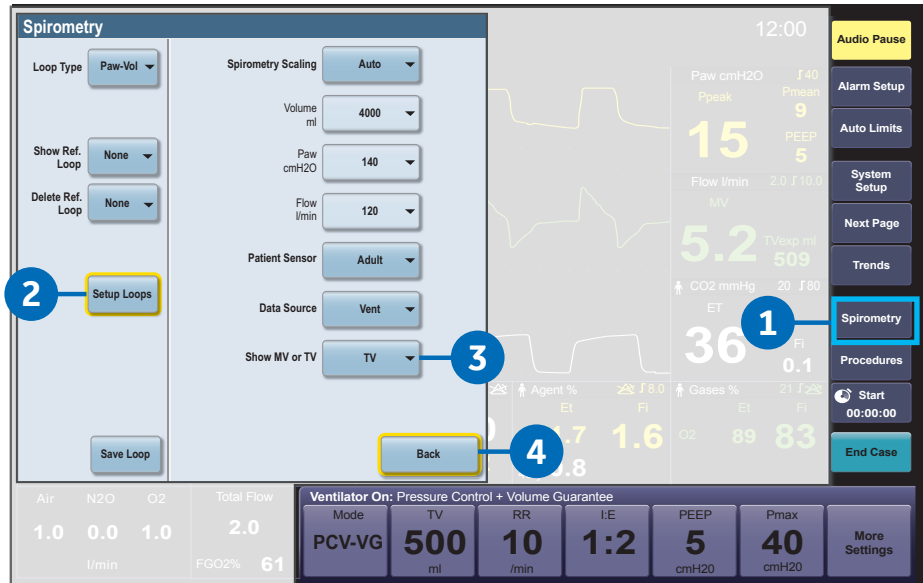

# Saving, Viewing and Deleting Spirometry loops

Spirometry loops can be saved, viewed, and deleted through the Spirometry menu.

1. Select Spirometry.
2. To store a loop to memory, select **Save Loop**. Up to six loops can be saved.
3. To view a saved loop, set **Show Ref. Loop** to the time at which it was saved.
4. To delete a saved loop, set **Delete Ref. Loop** to the time at which it was saved.
5. Select **Close**.

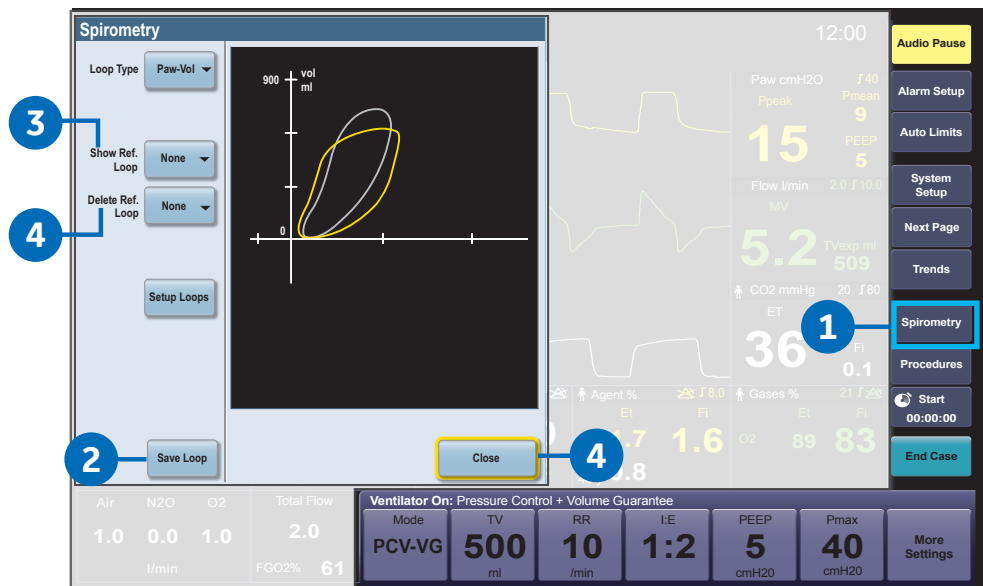



# 12 Screen Setup

## Overview

Use the Screen Setup menus to customize the screen view. There are three areas of the screen that can be customized to show specific information:

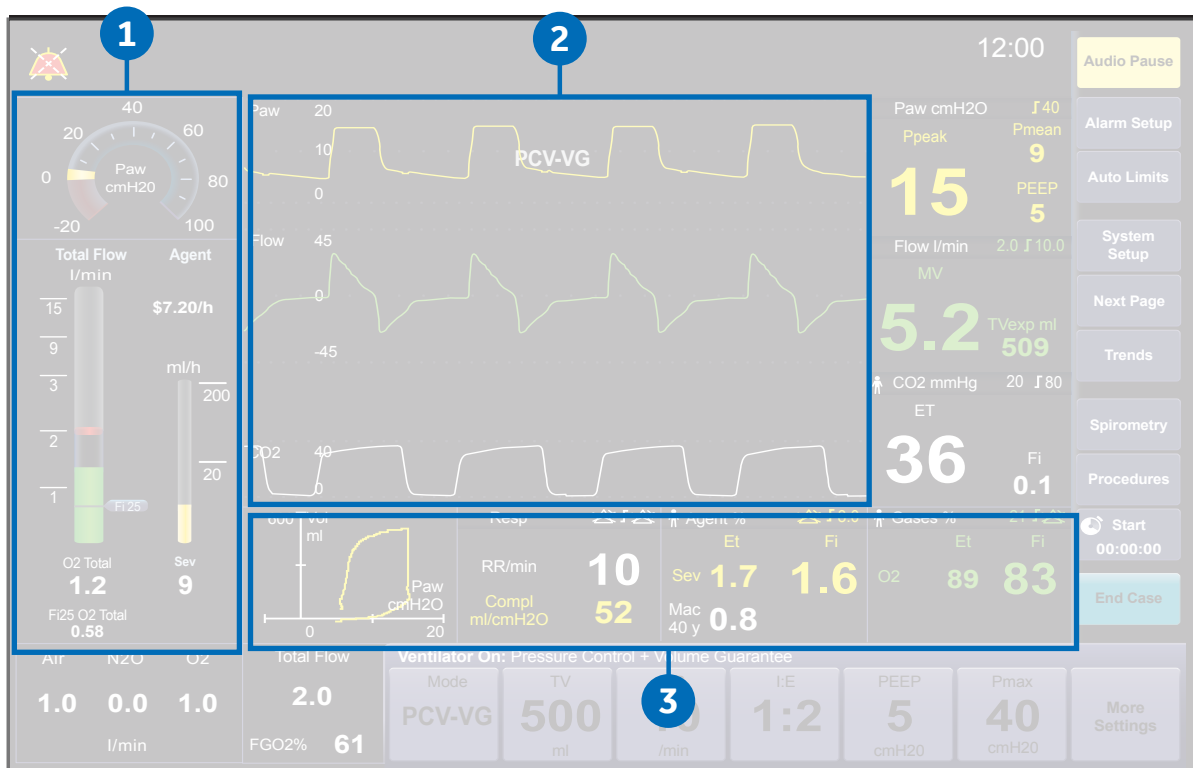

1. Split Screen
2. Waveform Fields
3. Digit Fields

# Setting Waveform Fields

Use the Screen Setup menus to customize the screen view, such as waveform fields, digit fields and split screen.

There can be a total of one, two or three waveforms displayed, depending on which waveform fields are turned off. The waveforms will resize to fill the entire waveform area as waveform fields are turned on and off.

## To Set Waveform Fields:

The waveforms can be set to show agent, CO<sub>2</sub>, flow, Paw, or set to Off. If a waveform is set to the same value as another waveform, the previously set waveform changes to off and is removed from the screen.

1. Select **System Setup > Screen Setup.**

 **Note:** The Screen Setup menu can also be accessed by touching the split screen area.

2. Select the **Layout** tab.
3. Select the desired **Waveform** button and select the value from the drop-down menu.
4. Select **Close.**

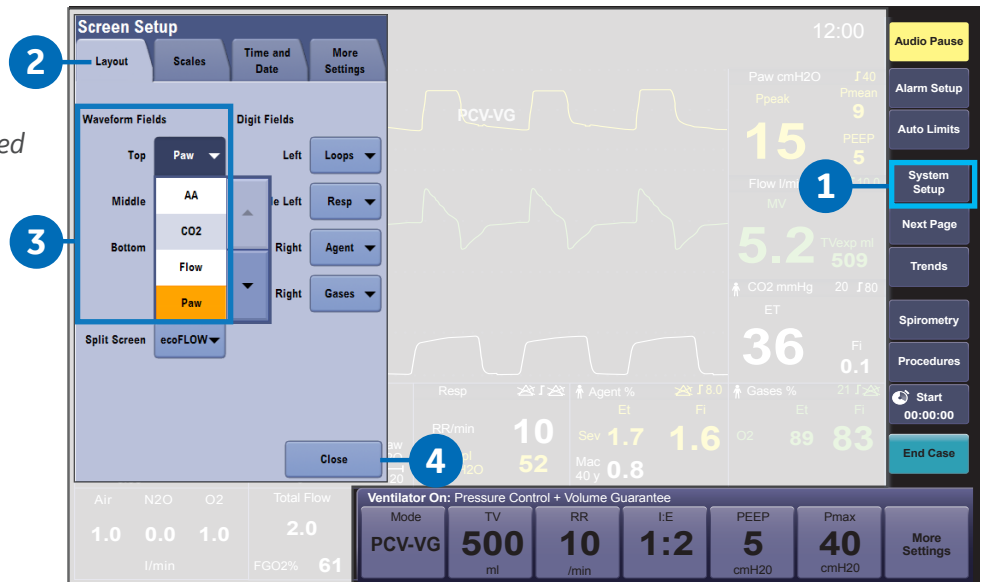

# Setting Digit Fields

The digit field can be set to show gas supply, flow, spirometry loops, gases, respiration, or agent. If the digit field is set to show agent and no airway module is inserted, the digit field will be blank.

## To Set Digit Fields:

1. Select **System Setup > Screen Setup.**

 **Note:** The Screen Setup menu can also be accessed by touching the split screen area.

2. Select the **Layout** tab.
3. Select the desired **Digit Field** button and select the value from the drop-down menu.
4. Select **Close.**

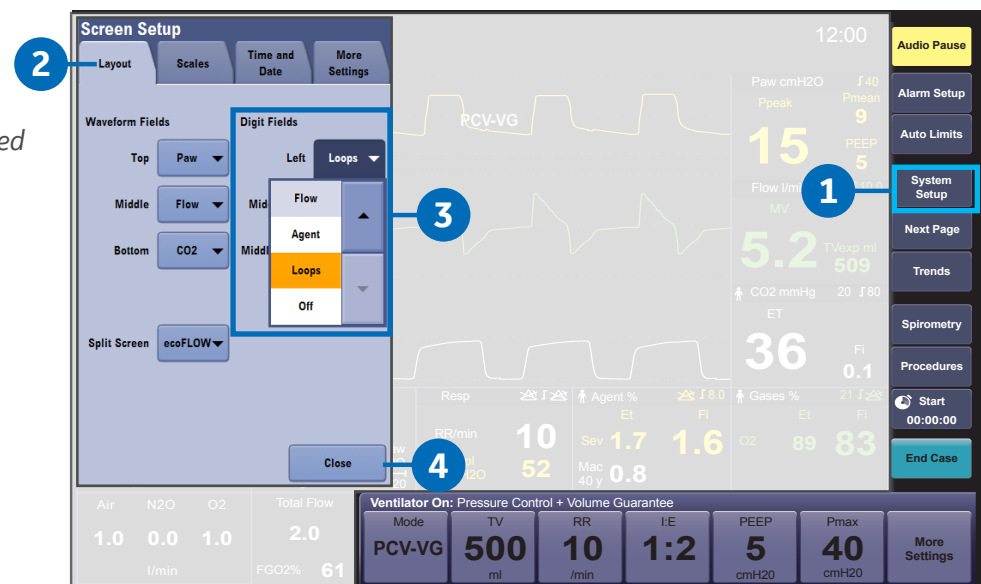

# Setting Split Screen

Use the Split Screen setting to show trends, spirometry loops, Paw gauge, airway compliance, and optional ecoFLOW information.

## To Set the Split Screen:

1. Select **System Setup > Screen Setup**.



**Note:** The Screen Setup menu can also be accessed by touching the split screen area.

2. Select the **Layout** tab.
3. Select **Split Screen** and select the desired view from the dropdown menu.
4. Select **Close**.

The screenshot shows the 'Screen Setup' menu with four numbered annotations: 1 points to the 'Split Screen' dropdown menu, 2 points to the 'Layout' tab, 3 points to the 'Split Screen' dropdown menu, and 4 points to the 'Close' button. The background shows a patient monitor display with various waveforms and data fields.

| Waveform Fields | Digit Fields |
|-----------------|--------------|
| Top: Paw        | Left: Loops  |
| Middle: AA      | Left: Resp   |
| Bottom: CO2     | Right: Agent |
|                 | Right: Gases |

Split Screen: ecoFLOW

Close

Ventilator On: Pressure Control + Volume Guarantee

| Mode   | TV     | RR      | I:E | PEEP    | Pmax     | More Settings |
|--------|--------|---------|-----|---------|----------|---------------|
| PCV-VG | 500 ml | 10 /min | 1:2 | 5 cmH2O | 40 cmH2O |               |



# 13 Integrated Auxiliary Options

## Using the ACGO

Use the optional Auxiliary Common Gas Outlet (ACGO) switch to direct the fresh gas flow through the ACGO port on the front of the system to an auxiliary manual breathing circuit. Fresh gas delivered through the ACGO port may contain O<sub>2</sub>, Air, N<sub>2</sub>O, and anesthetic agent, depending on user settings.

Mechanical ventilation is not available when using an auxiliary manual breathing circuit with fresh gas from the ACGO. The Bag/Vent switch, APL valve, and CO<sub>2</sub> absorber are not part of the external circuit. Volume is not available.

O<sub>2</sub> monitoring of fresh gas is available when the ACGO is selected if the system has the airway module option. Systems with the airway module option display the patient circuit O<sub>2</sub> value obtained from the airway module.

Delivered fresh gas O<sub>2</sub> concentration is calculated and displayed based on fresh gas flow control settings

### To Use the ACGO:

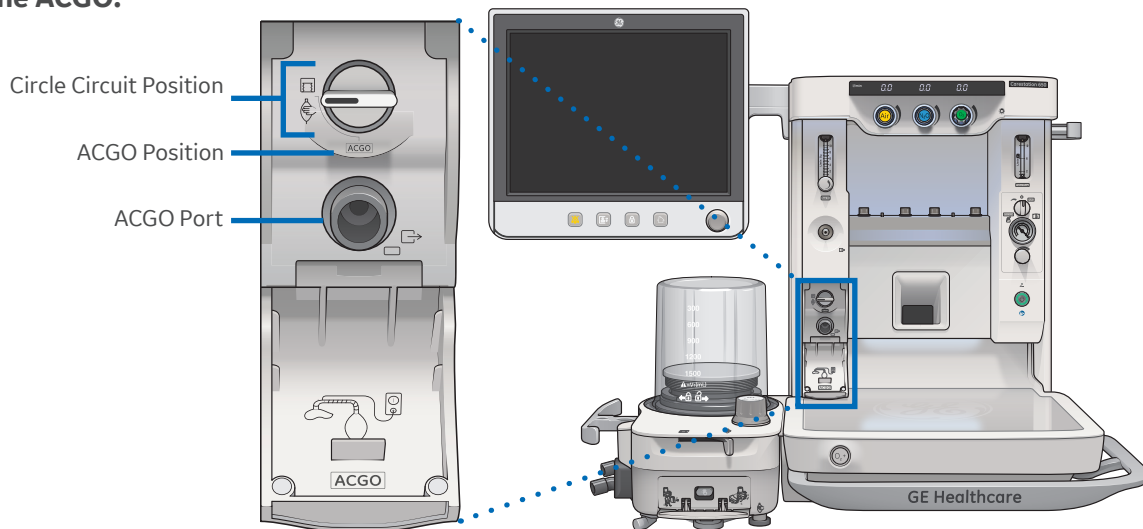

1. Open the ACGO switch cover.
2. Set the ACGO switch to the **ACGO** position to direct the fresh gas flow through the ACGO port.



**Note:** A light ring will activate around the ACGO port and the display will update to clearly indicate that the ACGO is in use.

3. Set the alarm limits to clinically appropriate settings.



**Note:** System has integrated ACGO port pressure monitoring, and will be displayed as P-ACGO in Paw gauge and Paw waveform on the display, if selected.

4. To stop fresh gas flow through the ACGO port, set the ACGO switch to the circle circuit position.



**Note:** The cover will not fully close if the ACGO switch is still in the ACGO position, as a reminder to the user to return the switch to circle position.

# The ACGO Display

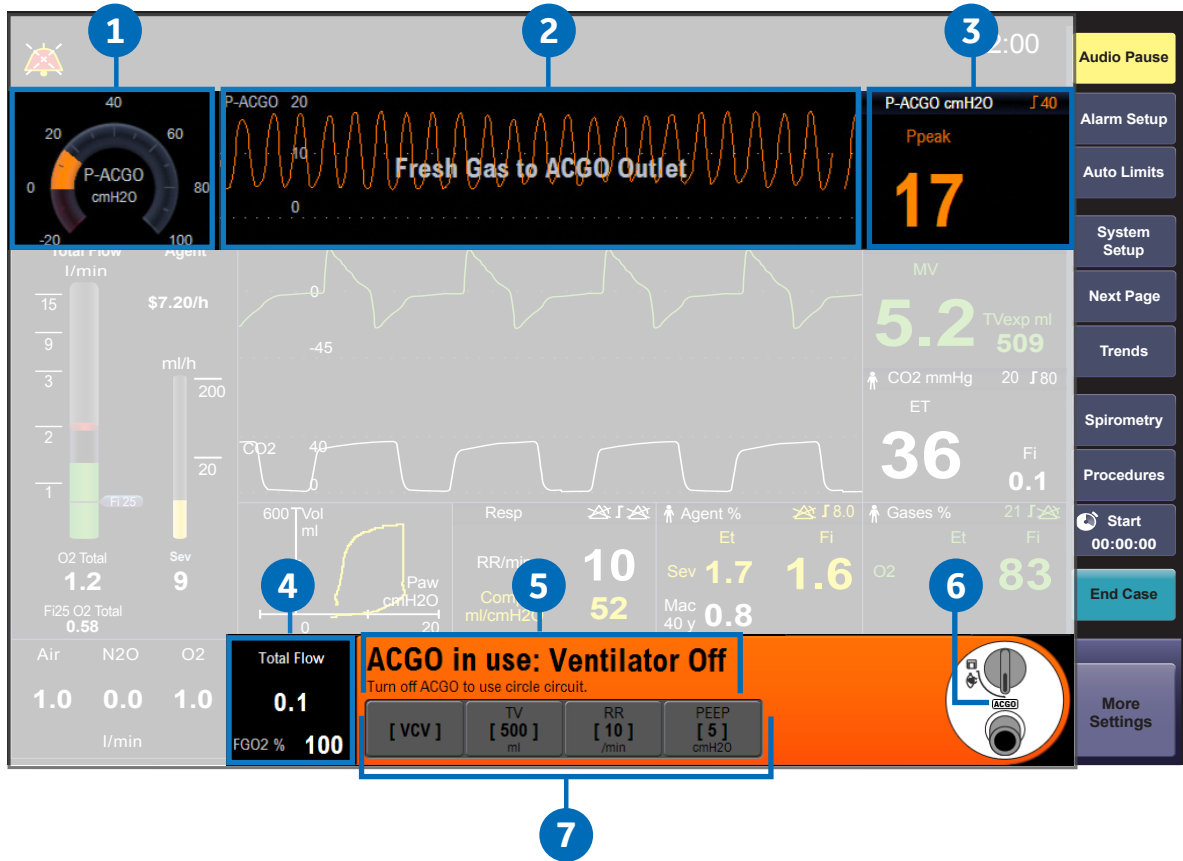

1. **Split Screen:** Shows ACGO pressure gauge (P-ACGO).
2. **Waveform Fields:** When pressure waveform is selected, displays the measured values for pressure through the ACGO port.
3. **Measured Values Field:** When pressure waveform is selected, displays the measured values for pressure through the ACGO port.
4. **Total Flow:** Shows information for Total Flow and FGO<sub>2</sub> %.
5. **Status Field:** Shows the ACGO status and alarm or status messages. For example: **ACGO in use: Ventilator Off**
6. **ACGO Status:** Shows that the ACGO switch is set to the ACGO position.
7. **Ventilator Quick Keys:** Displays preset ventilation parameters.



**Note:** If the Bag/Vent switch is set to Vent, returning the ACGO switch to circle position will immediately start mechanical ventilation.

# Using Aux O<sub>2</sub>+Air

Use the optional Auxiliary O<sub>2</sub>+Air (Aux O<sub>2</sub>+Air) switch to deliver O<sub>2</sub> and Air through the Aux O<sub>2</sub>+Air outlet on the front of the system. No anesthetic agent is delivered through the Aux O<sub>2</sub>+Air outlet. When the switch is set to the Aux O<sub>2</sub>+Air position during a case, the outlet indicator is lit and N<sub>2</sub>O flow is automatically shut off.

The Aux O<sub>2</sub>+Air outlet provides 100% O<sub>2</sub> or a mixture of O<sub>2</sub> and Air. The delivery default is 100% O<sub>2</sub>. Selecting the O<sub>2</sub>+Air quick key enables both O<sub>2</sub> and Air. Adjust the O<sub>2</sub> and Air individually using the flow control knobs.

## To Use the Aux O<sub>2</sub>+Air:

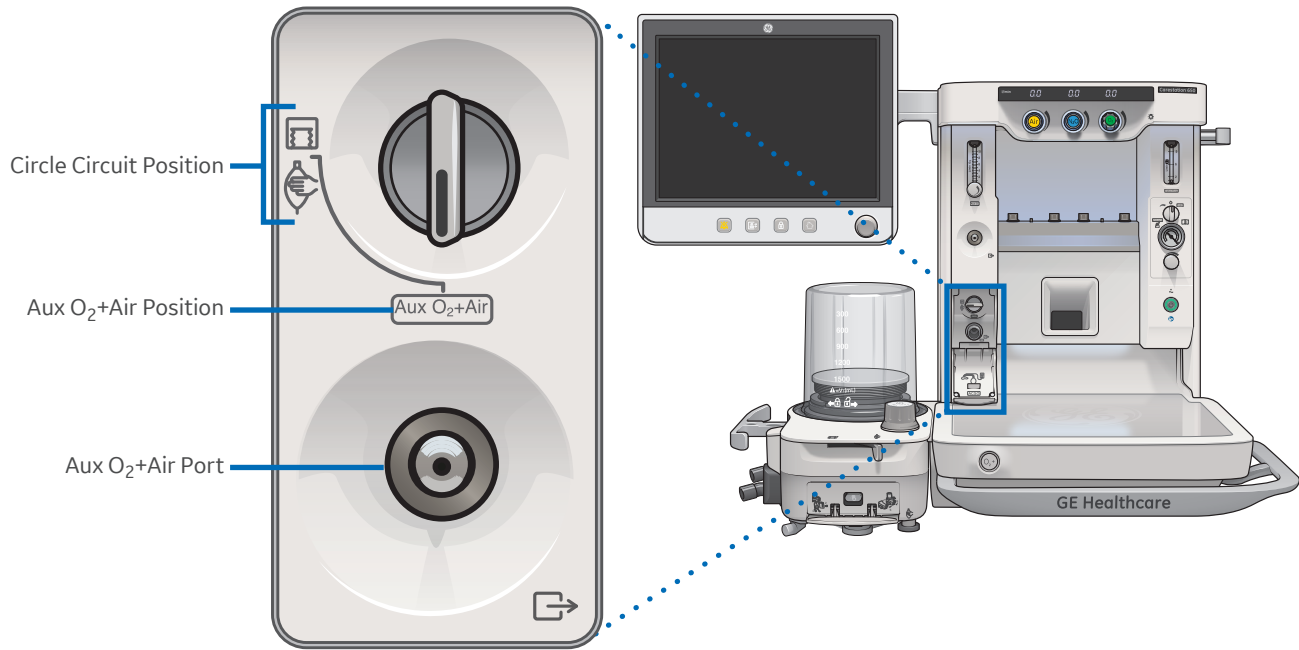

1. Set the Aux O<sub>2</sub>+Air switch to the **Aux O<sub>2</sub>+Air** position.



**Note:** A light ring will activate around the Aux O<sub>2</sub>+Air port and the display will update to clearly indicate that the Aux O<sub>2</sub>+Air is in use.

2. Aux O<sub>2</sub>+Air will immediately start flowing 100% O<sub>2</sub>, select **O<sub>2</sub>+Air** on the display to enable a mixed gas delivery.
3. Adjust O<sub>2</sub> and Air individually using the flow control knobs to reach the desired Auxiliary O<sub>2</sub>%



**Note:** Use of a lower O<sub>2</sub>% is recommended to reduce the risk of fires when using a heat source or device that may lead to combustion.

4. Set the switch to the circle circuit position to stop fresh gas flow through the Aux O<sub>2</sub>+Air outlet.

# The Aux O<sub>2</sub>+Air Display

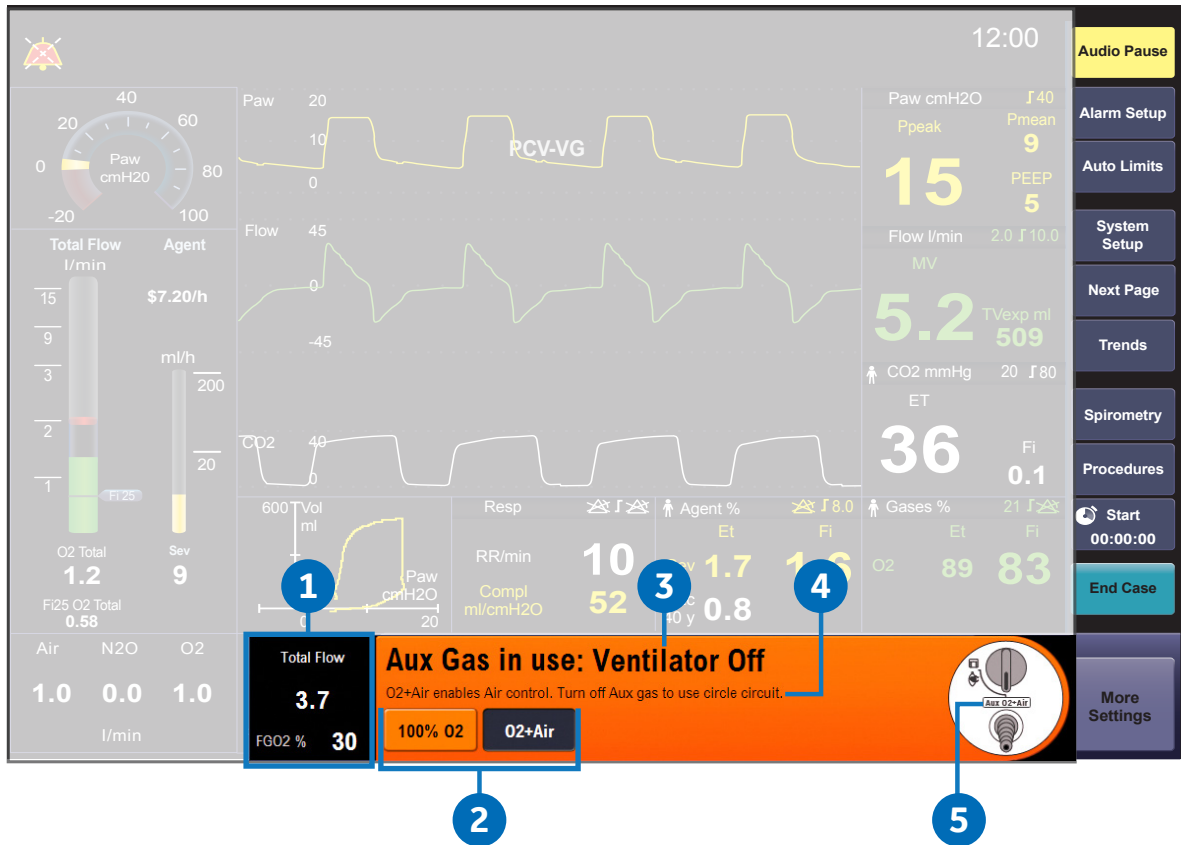

1. **Total Flow:** Shows information for Total Flow and FGO<sub>2</sub> % from the Aux O<sub>2</sub>+Air port.
2. **Quick Keys:** Shows gas selections: 100% O<sub>2</sub> or O<sub>2</sub>+Air.
3. **Status Field:** Shows Aux O<sub>2</sub>+Air status and alarm or status messages. For example: **Aux Gas in use: Ventilator Off**.
4. **Message Field:** Displays the message: O<sub>2</sub>+Air enables Air control. Turn off Aux gas to use circle circuit.
5. **Auxiliary Gas Status:** Shows that the Aux O<sub>2</sub>+Air switch is set to **Aux O<sub>2</sub>+Air** position.



# Auxiliary O<sub>2</sub> (Optional)

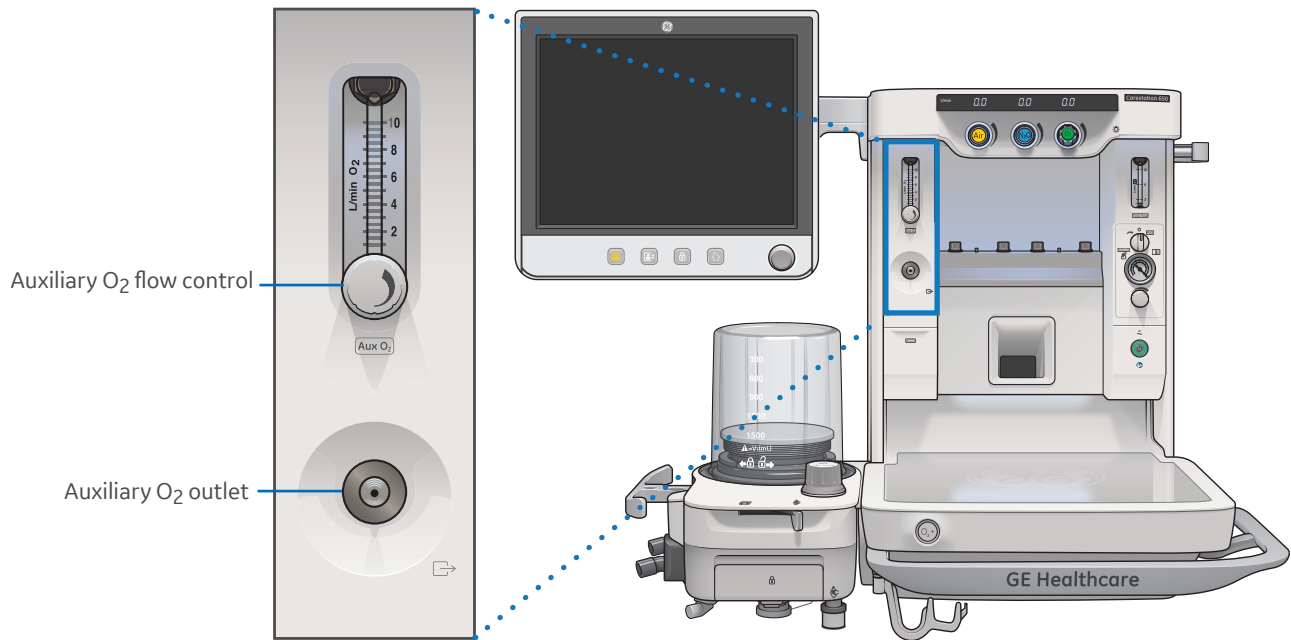

The auxiliary O<sub>2</sub> port is available to provide supplemental oxygen to patients undergoing surgical procedures. Turn the Auxiliary O<sub>2</sub> flow control knob counter-clockwise to increase flow, clockwise to decrease flow.



# 14 Alarm Setup

## Accessing the Alarm Setup Menu

To access the Alarm Setup menu:

The screenshot displays the 'Alarm Setup' menu with the following data:

| Parameter  | Low Limit | High Limit |
|------------|-----------|------------|
| Pmax cmH2O |           | 40         |
| MV l/min   | 1.3       | 5.5        |
| EtCO2 mmHg | 29        | 50         |
| FiO2 %     | 21        | 100        |
| FiSev %    | Off       | 8.0        |

Measured Values:

|            |     |
|------------|-----|
| Paw cmH2O  | 15  |
| Flow l/min | 2.0 |
| MV         | 5.2 |
| CO2 mmHg   | 36  |

Primary Limits Sub-menu:

- CO2 Alarms: On
- Vol Apnea Alarm: On
- MV/TV Alarms: On

Buttons: Alarm Setup, Auto Limits, System Setup, Next Page, Trends, Spirometry, Procedures, Start, End Case, Close.

1. Select **Alarm Setup** or...
2. Select one of the **Measured Value** fields.
3. The four submenus (Primary Limits, More Limits, Alarm History and Configure) can be selected from the **Alarm Setup** menu.

# Alarm Setup Menu Overview

The Alarm Setup menu contains the following submenus:

- 1. Primary Limits:** On/Off selections for CO<sub>2</sub> Alarms, Vol Apnea Alarm and MV/TV Alarm, plus primary low and high limit settings.
- 2. More Limits:** Additional low and high limit settings.
- 3. Alarm History:** A list of the 12 most recent high and medium priority alarms that occurred since the start of the case.
- 4. Configure:** Settings for Alarm Volume, Apnea Delay, Leak Audio and Auto MV Limits, plus the ability to change to default limits.

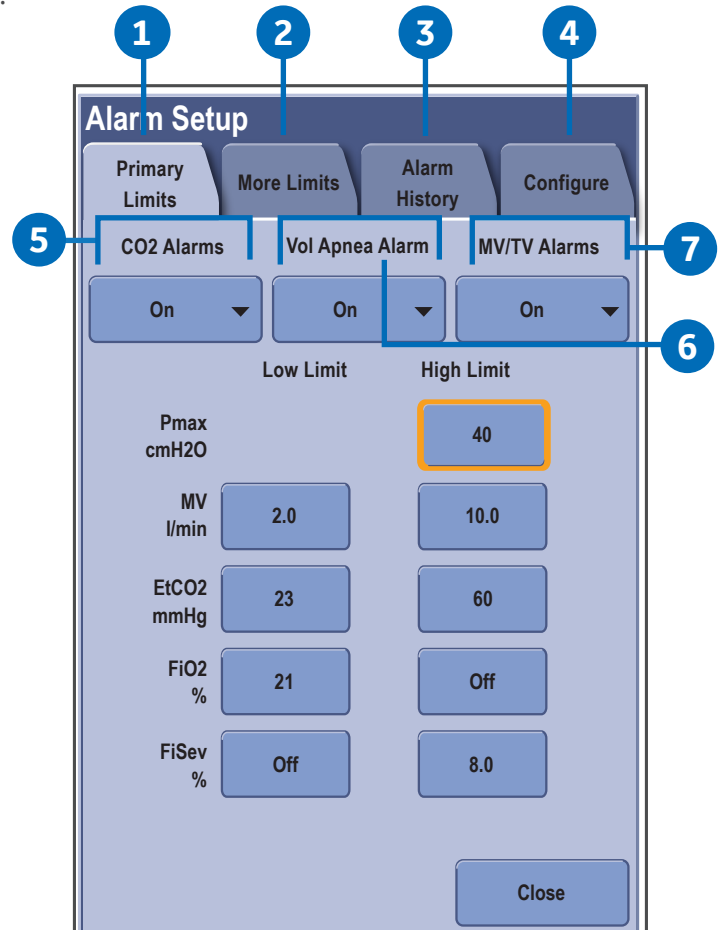

## CO<sub>2</sub>, Vol Apnea and MV/TV Alarms

The On/Off selections for CO<sub>2</sub> Alarms, Vol Apnea Alarm and MV/TV Alarms are available on the Primary Limits tab, with the following exceptions:

- The Volume Apnea Alarm selection will not be visible unless it has been enabled in the Super User mode
  - CO<sub>2</sub> Alarms and Vol Apnea Alarm can only be turned off while in manual ventilation, otherwise the selection will be grayed out
- 5. CO<sub>2</sub> Alarms:** During manual ventilation only, use the CO<sub>2</sub> Alarms setting to turn off most CO<sub>2</sub> alarms. The alarm remains disabled until the Bag/Vent switch is set to Vent, the case is ended, or the CO<sub>2</sub> Alarms is set to **On**.
  - 6. Vol Apnea Alarm:** During manual ventilation only, use the Vol Apnea Alarm setting to turn off the volume apnea alarm. The volume apnea alarm remains off until the Bag/Vent switch is set to Vent, or Vol Apnea Alarm is set to **On**. As noted, the Vol Apnea Alarm setting will not be visible unless it has been enabled in the Super User mode.
  - 7. MV/TV Alarms:** Use the MV/TV Alarms setting to turn off the MV and TV alarms. Settings made during manual ventilation are not retained when mechanical ventilation starts. Settings made during mechanical ventilation are retained when manual ventilation starts.

# The Alarm Setup Configure Menu

- 1. Alarm Volume:** Use the Alarm Volume setting to decrease or increase the alarm volume, with a range of 1 to 5.
- 2. Apnea Delay:** Use the Apnea Delay setting to set the desired apnea time delay. The apnea time delay is the amount of time that can pass without the system detecting a measured breath before the apnea alarm occurs. The range is 10 to 30 seconds in 1 second increments.
- 3. Leak Audio:** Use the Leak Audio setting to silence audio alarms of small leaks. If the Low MV alarm limits are off or MV/TV Alarms is set to Off, Leak Audio is automatically set to On and cannot be changed.
- 4. Auto MV Limits:** MV alarm limits can be calculated automatically for mechanical ventilation when in VCV or PCV-VG modes and volume compensation is enabled. Use the Auto MV Limits setting to turn on automatic calculations of the MV alarm limits. If the automatic calculation of the low or high minute volume alarm limit exceeds the allowable limit, the minimum or maximum alarm limit is used.
- 5. Change to Default Limits:** Use this selection to set alarm limits back to the default limits.

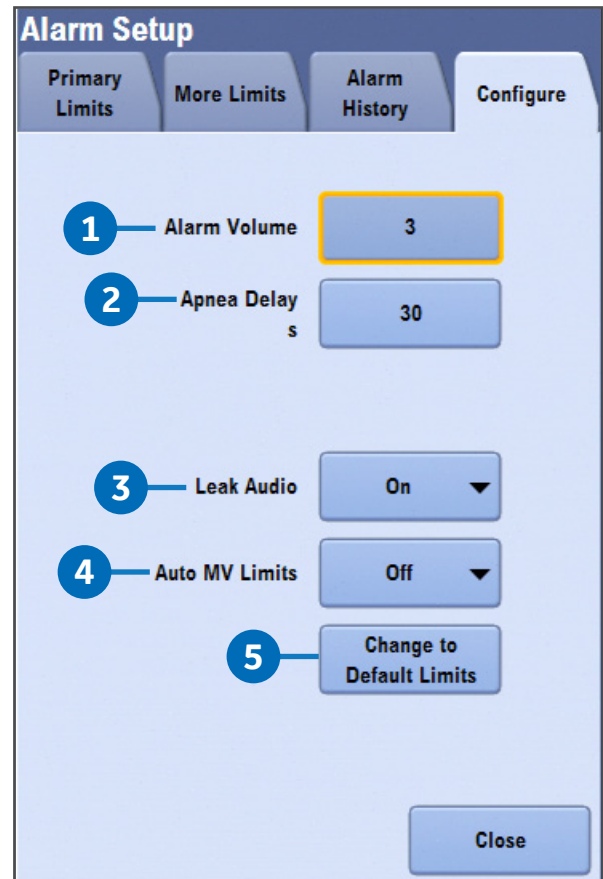



# 14 Super User

## Overview

Several settings can be changed in Super User mode. These changes should only be made by the person responsible for the configuration of the system. By configuring the system through the Super User mode, various default settings can be customized to meet the facility's needs.

To access the Super User mode, select System Setup and then Super User. The Super User mode is password protected. Contact the sales representative to obtain the password.

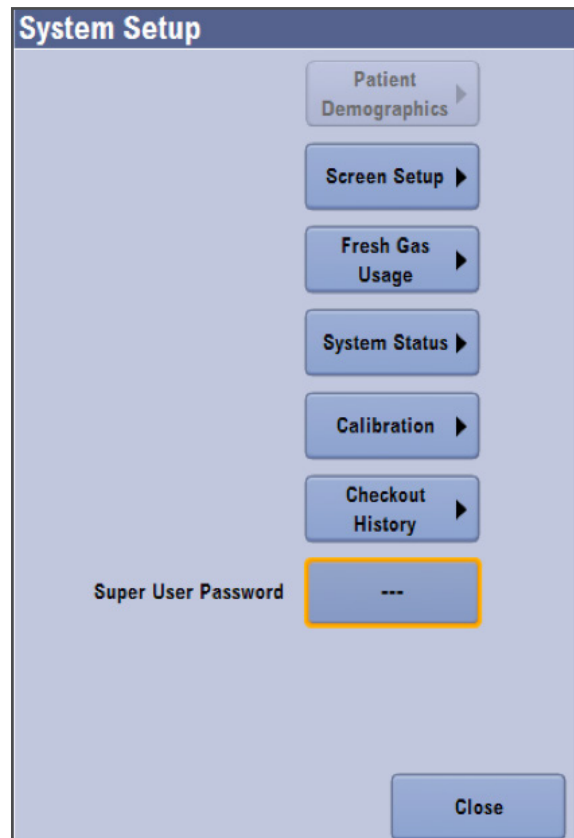

# Examples of Super User Settings

There are many settings that can be configured through the Super User mode, some examples include:

- Setting default colors for waveforms, digit fields and trends
- Setting units for patient weight, CO<sub>2</sub>, gas supply pressure and Paw
- Alarm settings such as showing the alarm limits for the primary parameters on the display
- Setting the default trend type
- Setting page views for custom screen configurations
- Case defaults, such as case names, patient defaults, alarm defaults and ventilator settings

There are also many features that can be turned on and off in the Super User mode. If a feature or setting is missing from a menu, it may have been turned off in the Super User mode. Some examples of feature/settings that can be turned on and off include:

- The Vital Capacity procedure (along with the PEEP on Exit setting within the Vital Capacity procedure)
- The Cycling Procedure
- The Vol Apnea Alarm selection on the Alarm Setup menu



# 15 Setting up the Absorber Canister

## Overview

The absorber canister is available in two versions: disposable absorber and reusable absorber. Both are removed and installed on the breathing system the same way.

Each reusable canister holds 1150 grams of loose absorbent. Each disposable canister holds 1200 grams of loose absorbent.

Both absorber versions should only be used with mixtures of air, oxygen, nitrous oxide, halothane, enflurane, isoflurane, Desflurane and sevoflurane.

### When to change the absorbent

A gradual color change of the absorbent in the canister indicates absorption of carbon dioxide. The color change of the absorbent is only a rough indicator. Use carbon dioxide monitoring to determine when to change the canister.

Immediately discard the absorbent if it has changed color. If left standing for several hours, absorbent may regain its original color giving a misleading indication of effectiveness.

1. Disposable Absorber Canister
2. Canister Handle
3. Canister Lifter Handle
4. Canister Lifter Base
5. Reusable Canister Lid Latch Mechanism
6. Maximum Absorbent Capacity Level

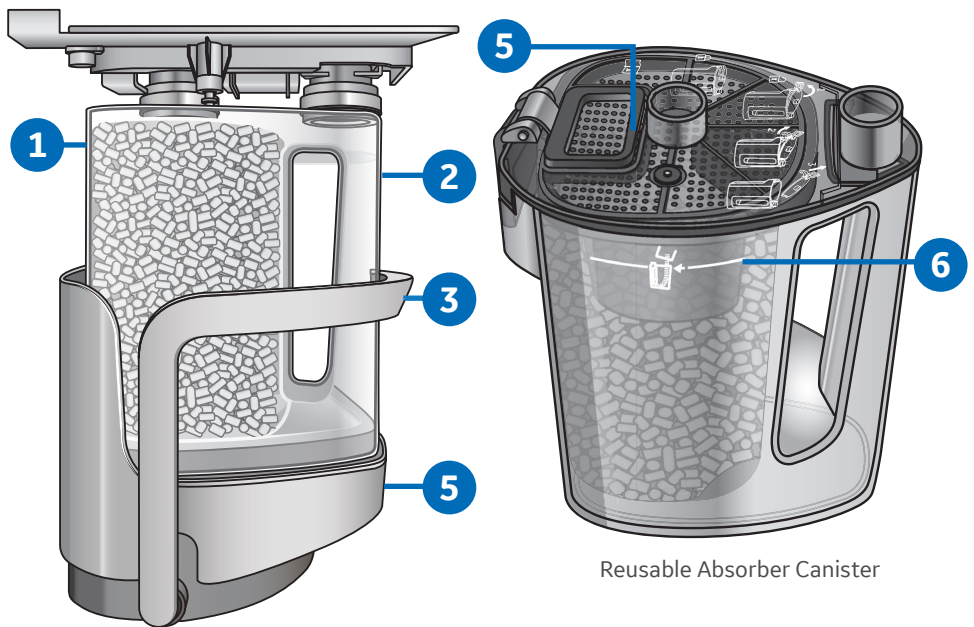

Disposable Absorber Canister

Reusable Absorber Canister

# Removing the Absorber Canister

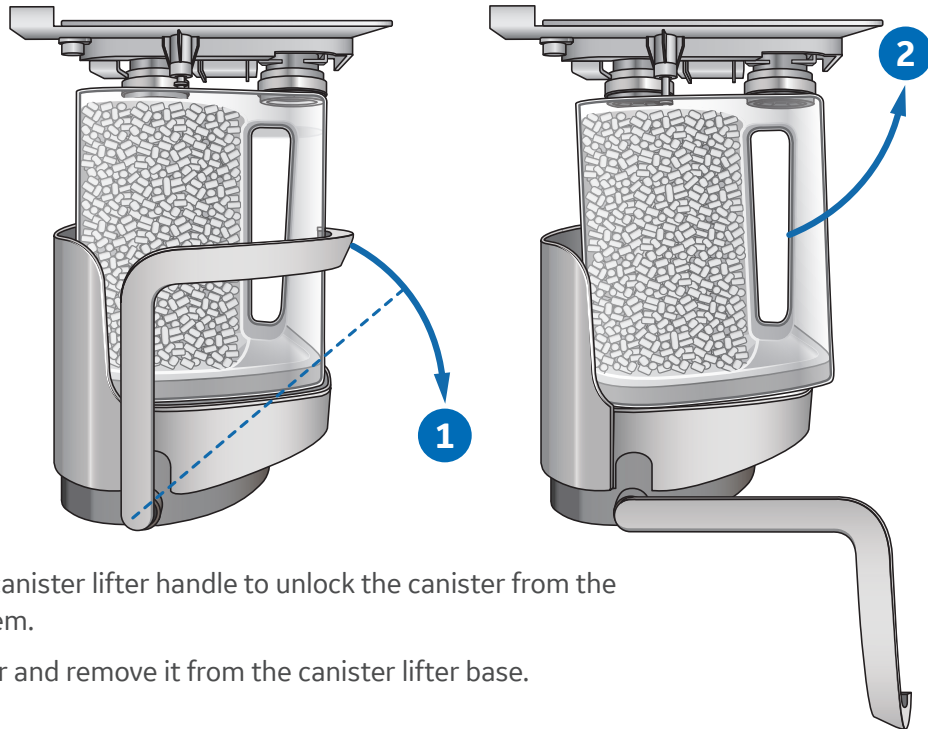

1. Pull down the canister lifter handle to unlock the canister from the breathing system.
2. Lift the canister and remove it from the canister lifter base.

# Filling the Absorber Canister

1. Wipe off any absorbent dust on the top cover wiper seal and the canister sealing area.



**Note:** The top cover wiper seal may discolor over time; however color change alone has no effect on seal function.

2. Insert the cover into the groove on the canister handle so that the arrows get covered by the black zone.
3. Attach the cover latch hook to the canister body. Push the latch handle down until it is flush with the canister cover.

**Warning:** Failure to properly lock the canister cover could cause canister malfunction and breathing circuit leaks. The locking tab of the canister cover must be in the downward position and flush with the cover.

4. Place the canister onto the canister lifter base.
5. Pull the canister lifter handle up to lock the canister into the breathing system.
6. Always perform a **Preoperative checkout** (from the user's reference manual) after reassembly and before using the anesthesia system.



**Note:** Reusable absorber canisters can be cleaned and autoclaved. To clean and disinfect the canister, refer to **Automated washer** in the **Cleaning and sterilization** user's manual.

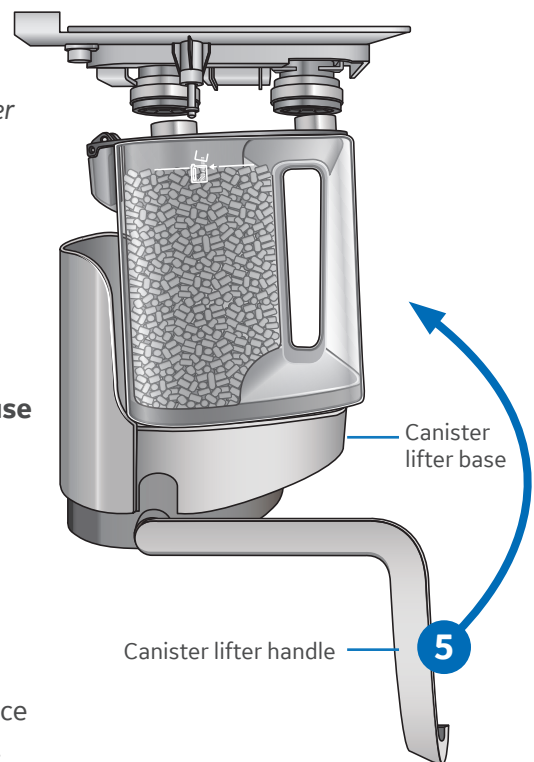

# Filling the Reusable Absorber Canister



1. To open the canister cover, lift the latch handle up.
2. Push the latch handle down to release the cover.
3. Pull the latch hook away from the canister and lift the cover off the canister.
4. Remove and properly discard the absorbent and any water in the canister body.
5. Pour fresh absorbent into the canister.
6. Gently shake the canister from side to side to level the top of the absorbent. Make sure the absorbent in the canister does not exceed the fill line.



**Note:** Reusable absorber canisters can be cleaned and autoclaved. To clean and disinfect the canister, refer to **Automated washer** in the **Cleaning and sterilization** user's manual.



# 16 User Maintenance and Testing

## Calibrating the O<sub>2</sub> Cell

### Accessing the Calibration menu:

There are two ways to access the Calibration menu:

1. Select **System Setup > Calibration**.
2. Select **Checkout > Calibration**.

### Weekly O<sub>2</sub> cell calibration:

Weekly O<sub>2</sub> cell calibration will calibrate the O<sub>2</sub> cell to 21% O<sub>2</sub>, through exposure to room air.

- From the Calibration menu, select **Weekly O<sub>2</sub> Cell**.
- Follow the instructions on the screen.

### Monthly O<sub>2</sub> cell calibration:

Monthly O<sub>2</sub> cell calibration will calibrate the O<sub>2</sub> cell to 100% O<sub>2</sub>, through exposure to 100% O<sub>2</sub> supply.

- Make sure the patient connection is not plugged or there is no patient tubing connected to the system.
- (ACGO option only.) Set the ACGO switch to Circle.
- (Aux O<sub>2</sub>+Air option only.) Set the Aux O<sub>2</sub>+Air switch to Circle.
- Set the Bag/Vent switch to Vent.
- From the Calibration menu, select **Monthly O<sub>2</sub> Cell**.
- Follow the instructions on the screen.

The screenshot displays the 'Calibration' menu on a ventilator interface. The menu is divided into two main sections: 'Flow and Pressure' and 'Calibration History'. The 'Flow and Pressure' section has four options: 'Flow and Pressure' (highlighted with a blue box and a '1' in a blue circle), 'Weekly O<sub>2</sub> Cell', 'Monthly O<sub>2</sub> Cell', and 'Airway Gas'. The 'Calibration History' section shows a table of past calibrations:

| Calibration Type            | Last | Date/Time            |
|-----------------------------|------|----------------------|
| Flow and Pressure           | Last | 09-Jan-2015 10:11 AM |
| Weekly O <sub>2</sub> Cell  | Last | 27-Feb-2015 07:31 AM |
| Monthly O <sub>2</sub> Cell | Last | 27-Feb-2015 07:33 AM |
| Airway Gas                  | ---  | ---                  |

At the bottom of the screen, there is a 'Ventilator Off: Volume Control' status bar with various parameters: Mode [ VCV ], TV [ 500 ] ml, RR [ 12 ] /min, I:E [ 1:2 ], Tpause [ Off ], PEEP [ Off ] cmH<sub>2</sub>O, and Pmax [ Off ] cmH<sub>2</sub>O. The 'Checkout' option is also highlighted with a blue box and a '2' in a blue circle.

# Calibrating the Flow Sensors

Calibrate the flow sensors by opening the breathing circuit. Onscreen instructions are available through the Checkout menu or **System Setup > Calibration > Flow and Pressure**.

1. Pull down the canister lifter handle and remove the absorber canister.
2. Open the breathing system door. Push the release button to unlock the breathing system.
3. Lower the breathing system.

 **Note:** The breathing system should be completely disconnected from the system (fully rotated down) to obtain an accurate calibration.

4. Wait for **No insp flow sensor** and **No exp flow sensor** alarms to occur.
5. Lift and reattach the breathing system.
6. Close the breathing system door. Wait for alarms to clear.
7. Place the canister onto the canister base.
8. Pull the canister lifter handle up to lock the canister into the breathing system.

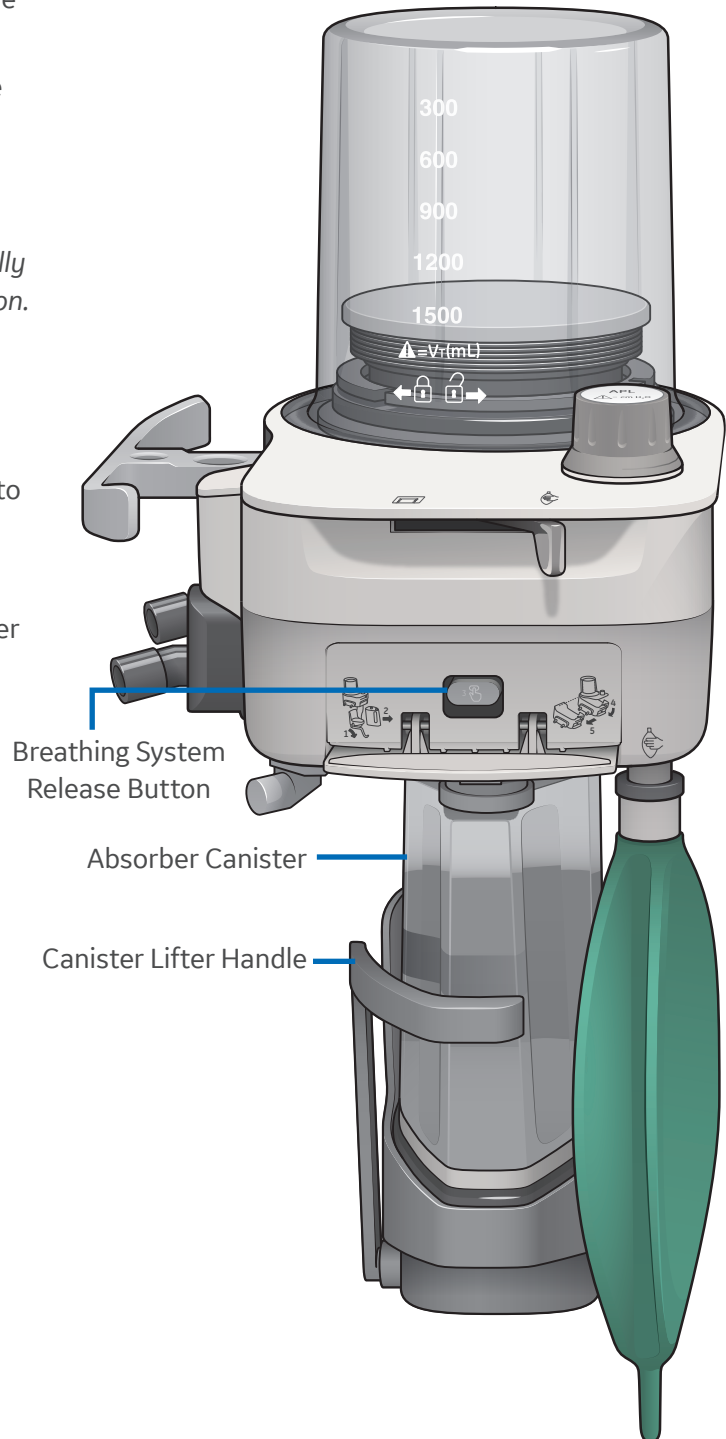

# Calibrating the Airway Module

Calibrate airway modules once every six months or whenever there are indications of errors in the gas readings. Use a manufacturer approved calibration gas and regulator to calibrate the modules.

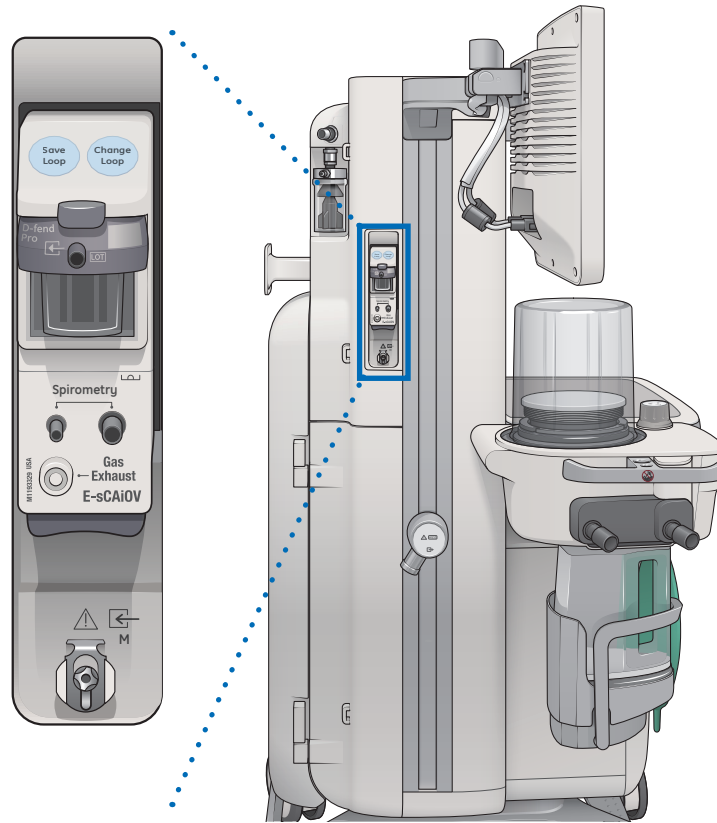

1. Turn on the power. Let the module warm up for 30 minutes before starting calibration.
2. Attach the regulator to the calibration gas cylinder.
3. Attach a new sampling line to the water trap. Connect the loose end of the sampling line to the regulator on the calibration gas cylinder.
4. Select the **System Setup** button.
5. Select **Calibration**.
6. Select **Airway Gas**.
7. Wait until **Connect the calibration gas and feed gas** appears on the anesthesia display.
  - If an error occurs during calibration or if no gas is fed, the calibration shows **Fail**. Select **Back** to perform a new calibration.
8. For regulators with a numbered gauge, open the regulator until the gauge reads between 5 to 7 psi (34 to 48 kPa). For regulators with a non-numbered gauge, open the valve.
9. Feed the calibration gas until **End gas feed. Match the values with the calibration gas. Confirm each** appears.
10. Close the regulator.
11. Compare the measured values shown on the screen, by gas, against the calibration gas cylinder value. If a gas needs adjustment, select the gas to be adjusted. Use the ComWheel to change the value until it matches the calibration gas cylinder value. Push the ComWheel to confirm the change. If a gas does not need adjustment, select the gas. Push the ComWheel to confirm the value.
12. After all values are confirmed, the calibration result is displayed.

# Maintenance Summary and Schedule

These schedules indicate the minimum frequency of maintenance based on typical usage of 2000 hours per year. Service the equipment more frequently if it is used more than the typical yearly usage. Please contact an authorized representative of the manufacturer for information concerning the decommissioning of equipment. Equipment and accessories must be disposed of in accordance with applicable regulatory and hospital requirements in effect at the time and place of disposal. **Note:** Local policies or regulations may require that maintenance be performed more frequently than stated here.

## CAUTION

Do not wipe the surfaces or clean the system using organic, halogenated, or petroleum-based solvents, anesthetic agents, glass cleaners, acetone, or other harsh cleaning agents. Doing so can damage the labels or the system. Refer to the “Cleaning and Sterilization” manual for additional cleaning information.

| Minimum Frequency  | Maintenance   |
|--|---|
| Daily  | <ul style="list-style-type: none"> <li>• Clean the external surfaces.</li> <li>• Replace the absorbent in the canister (as needed).</li> </ul>  |
| Weekly   | Perform weekly O <sub>2</sub> cell calibration.   |
| Two weeks  | <ul style="list-style-type: none"> <li>• Drain the vaporizers and discard the agent. (This is not necessary for the Tec™ 6 series vaporizers.)</li> <li>• Perform a flow and pressure calibration.</li> </ul>   |
| Monthly  | Perform monthly O <sub>2</sub> cell calibration.  |
| During cleaning and setup  | Inspect the parts for damage. Replace or repair as necessary.   |
| As necessary   | <ul style="list-style-type: none"> <li>• Install new cylinder gaskets on cylinder yokes.</li> <li>• Replace the absorbent in the canister.</li> <li>• Empty and clean the overflow trap on the optional suction regulator.</li> <li>• Replace the circuit O<sub>2</sub> cell. (Under typical use the cell meets specifications for 2 years.)</li> <li>• Replace the autoclavable flow sensors. (Under typical use the sensor meets specifications for a minimum of 1 year.)</li> <li>• Calibrate the airway modules every 6 months or when there are indications of errors in the gas readings. Calibrate airway modules that get extensive usage every 2 months.</li> <li>• Inspect and clean the fan filters (airway module).</li> <li>• Empty D-fend Pro water trap on the airway module.</li> </ul> |
| <p><b>Authorized service personnel:</b> This is the minimum level of maintenance recommended. Local regulations may contain additional maintenance requirements. Comply with all local regulations which meet or exceed this minimum level of maintenance.</p> |   |
| 12 months  | Have an authorized service representative complete the scheduled service maintenance checks, tests, calibrations, and parts replacements as defined in the Technical Reference manual.  |



# Low Pressure Leak Test (with ACGO)

The Low Pressure Leak Test is an optional test, as the vaporizers and low pressure system are tested during the Full Test Checkout.

## To perform the Low Pressure Leak Test:

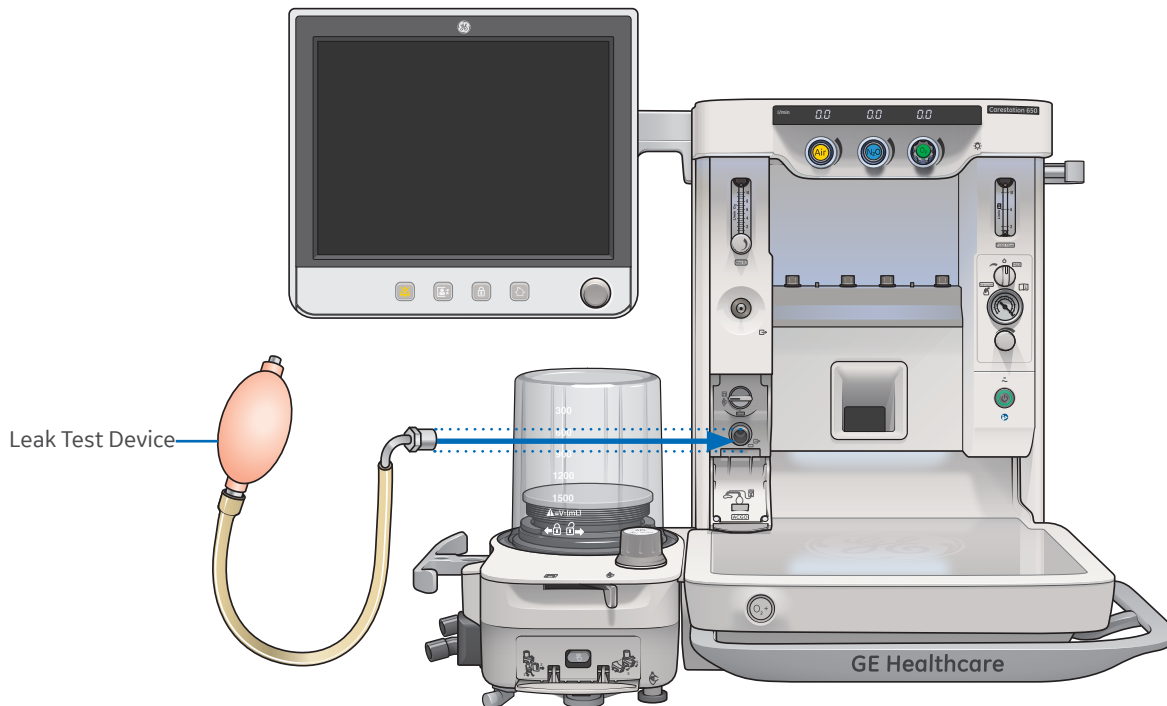

1. Check the leak test device.
  - Put your hand on the inlet of the leak test device. Push hard for a good seal.
  - Squeeze the bulb to remove all air from the bulb.
  - If the bulb completely inflates in less than 60 seconds, replace the leak test device.
2. Turn off the system.
3. Set the ACGO switch to the ACGO position.
4. Turn off all vaporizers.
5. Test the anesthesia machine for low-pressure leaks:
  - Turn all flow controls fully clockwise (closed). Do not overtighten.
  - Connect the leak test device to the ACGO outlet.
  - Squeeze the bulb repeatedly until it is empty.
  - If the bulb completely inflates in 30 seconds or less, there is a leak in the low-pressure circuit.
6. Test each vaporizer for low-pressure leaks:
  - If testing a Tec 7 vaporizer set to 1%.
  - If testing a Tec 6 Plus vaporizer set to 12%.
  - Repeat step 5.
  - If the bulb completely inflates in 30 seconds or less, there is a leak in the vaporizer tested.
  - Set the vaporizer to Off.
  - Test the remaining vaporizers.
7. Remove the test device from the ACGO port.



# 17 Pneumatic Connections

## Pipeline Inlets

The pipeline inlets accept up to three different gases: O<sub>2</sub>, Air, and N<sub>2</sub>O. A fourth pipeline inlet is available for a secondary, backup low-pressure O<sub>2</sub> supply connection.

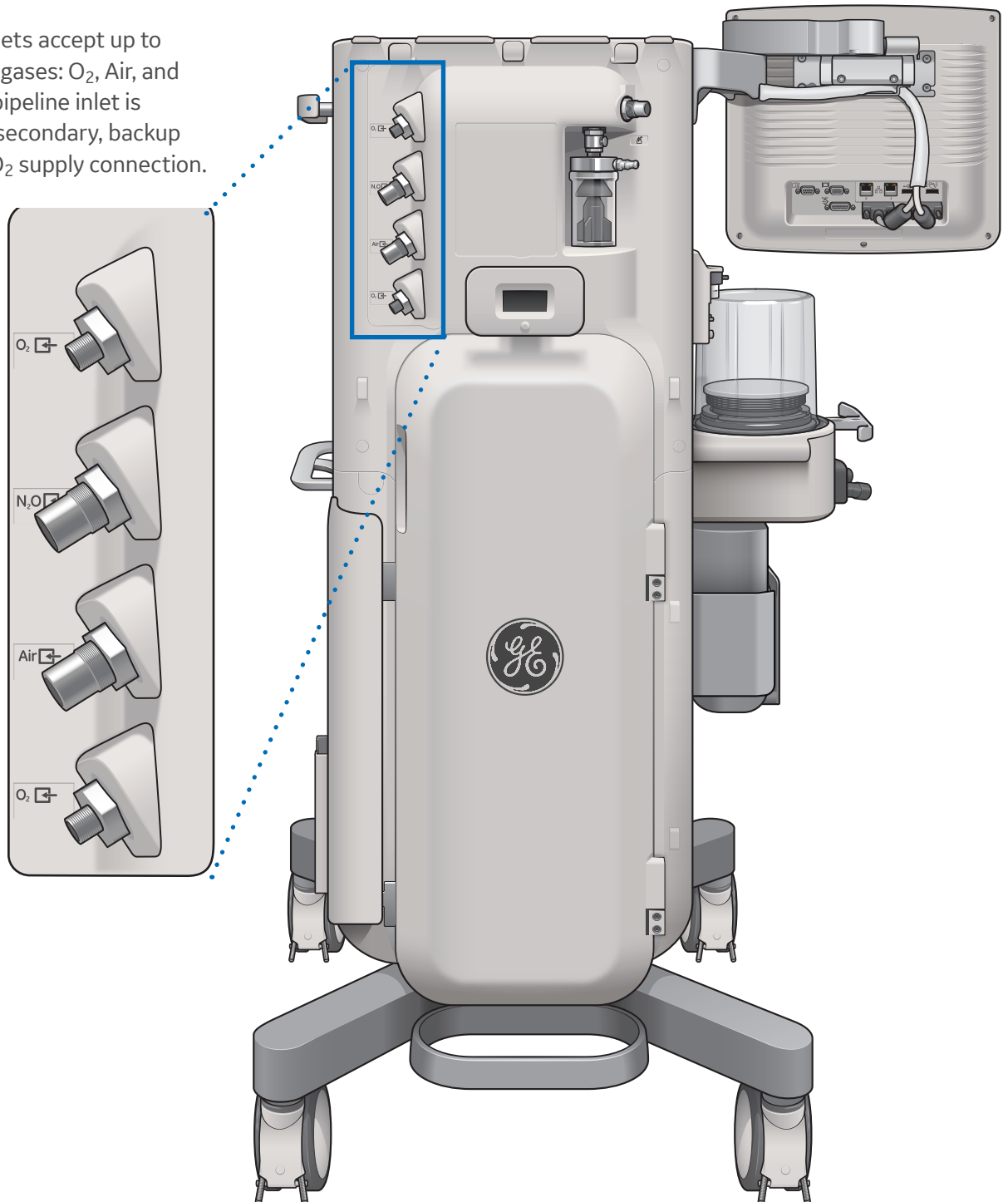

# Suction Connections (Optional)

There are two types of suction connections:

- Vacuum Suction: Uses an external vacuum supply. Connect the vacuum connection to the source vacuum supply. Connect the collection bottle connection to the collection bottle.
- Venturi Suction: Uses the system air or O<sub>2</sub> supply source. Connect the collection bottle connection on the overflow safety trap to the collection bottle.

1. Overflow Safety Trap.
2. External Vacuum Connection (on the Venturi suction option, this is replaced with a Venturi muffler).
3. Collection Bottle Connection.
4. Splash Guard.

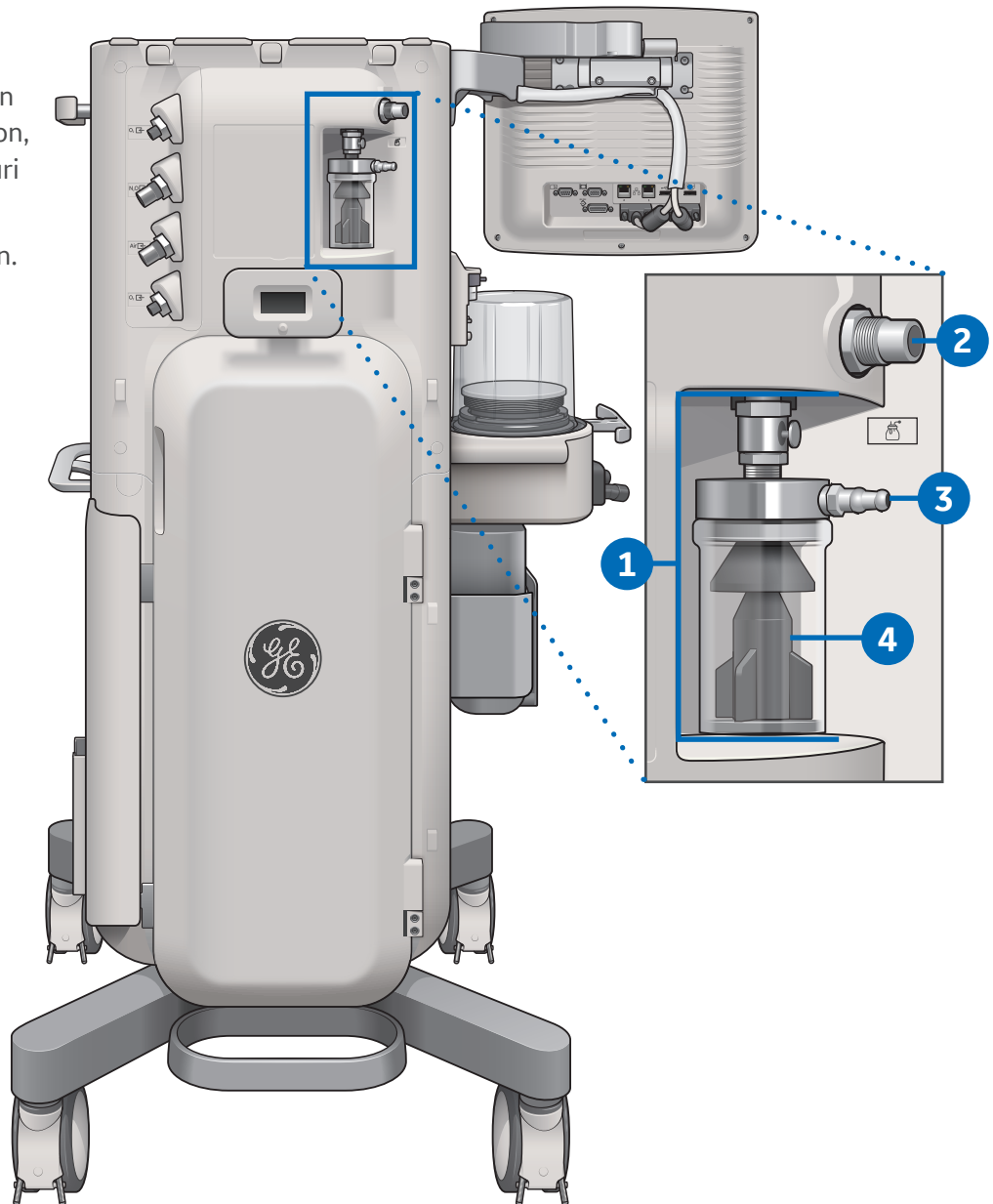

# Pneumatic Connections

The AGSS port is located behind the breathing system. An adapter may be necessary to interface to the scavenging connector.

## Passive AGSS

The optional passive anesthesia gas scavenging system (AGSS) is for use in operating room environments that do not have an active gas extraction system for waste gas disposal. The passive AGSS contains both positive and negative pressure relief valves to protect the breathing system and the patient.

## Active AGSS

There are several versions of the optional active Anesthesia Gas Scavenging System (AGSS) available depending on the hospital's type of waste gas disposal system.



**Note:** For more information on scavenging connections, please refer to the system's user's reference manual. To avoid possible exposure to anesthetic agent, always verify the proper operation of any gas scavenging system. Make sure the scavenging system is not occluded.

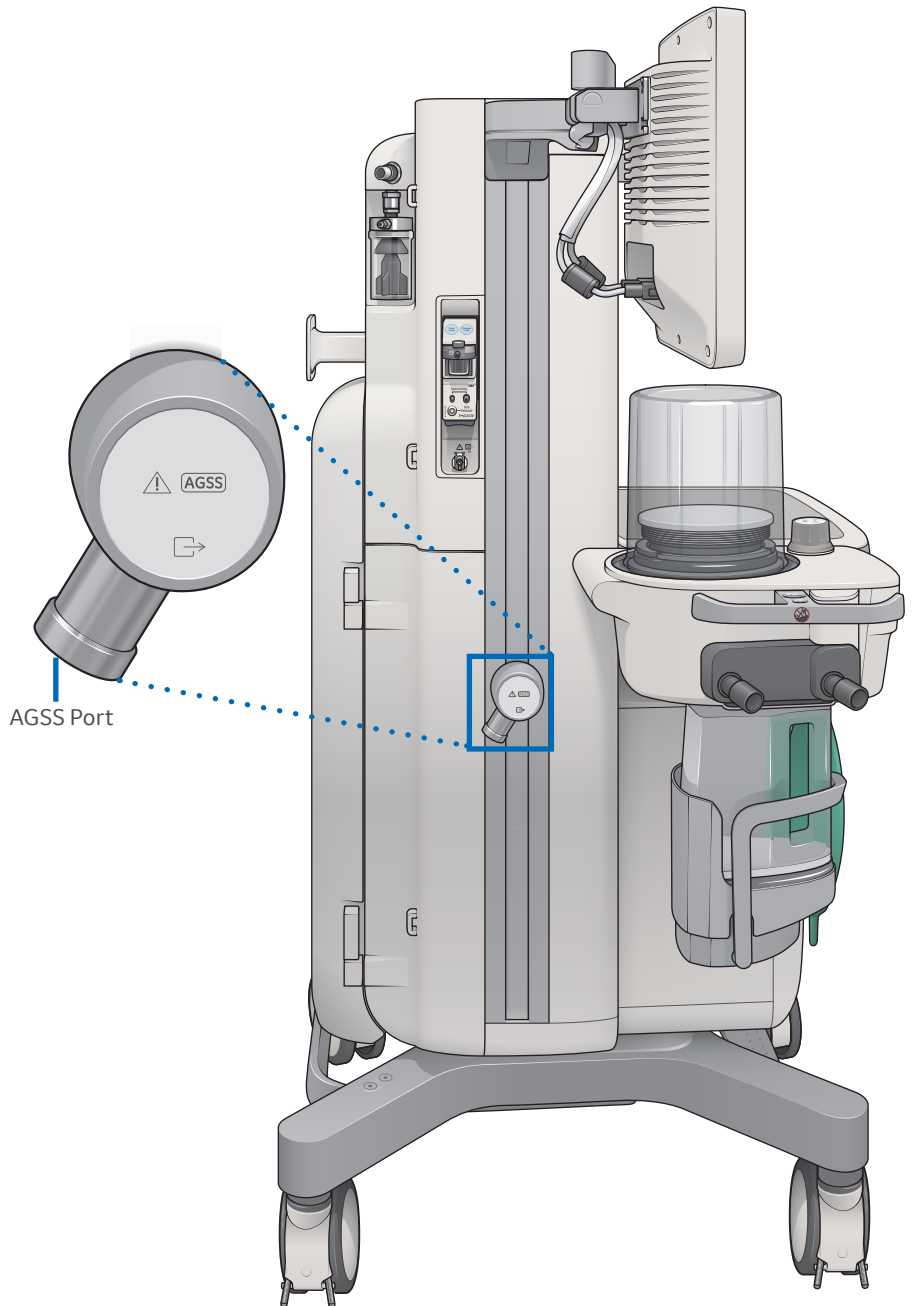



# 18 Installing Gas Cylinders

## Overview

Some systems have an optional cylinder cover. The cover needs to be opened before installing or removing cylinders.

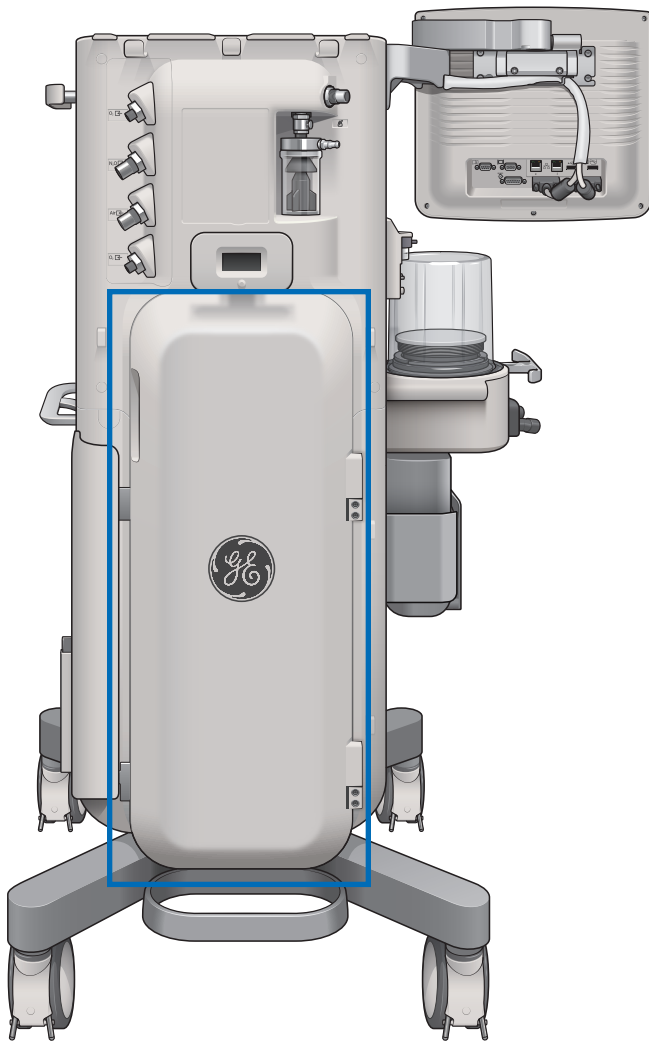

Carestation 600 Series with Optional Cover

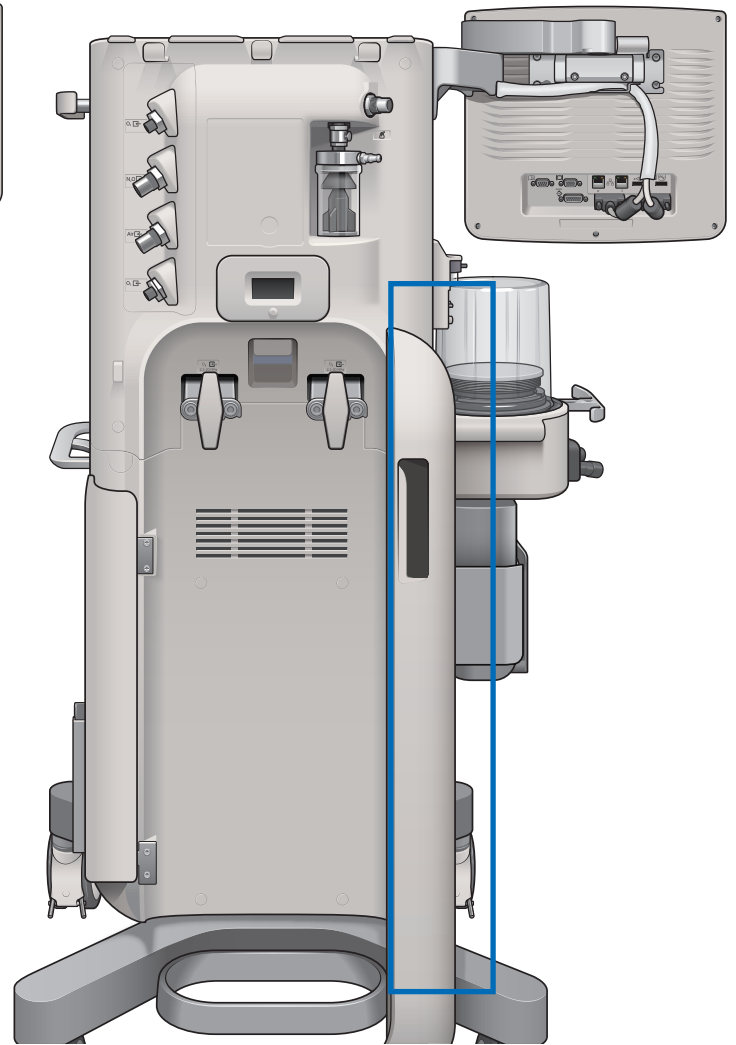

Carestation 600 Series with cover open

# Installing Cylinders with Pin Indexed Yokes

1. Locate the cylinder wrench.
2. Close the cylinder valve on the cylinder to be replaced.
3. Loosen the tee handle.
4. Open the cylinder yoke.
5. Remove the used cylinder and the used gasket.
6. Remove the cap (if equipped) from the cylinder valve on the new cylinder.

**Warning:** Make sure there is only one gasket on the cylinder connection. No gasket or more than one gasket can cause a leak.

7. Install a new gasket.
8. Align the cylinder post with the index pins.
9. Close the yoke gate and tighten the tee handle.
10. Make sure there is a cylinder plug and gasket in any empty cylinder yokes.
11. Complete **Performing a high-pressure leak test.**

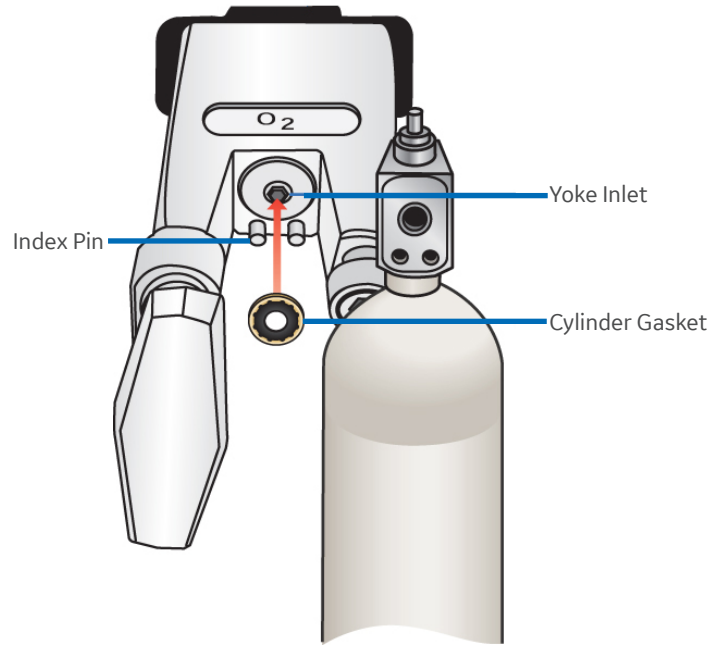



# Performing a High-Pressure Leak Test

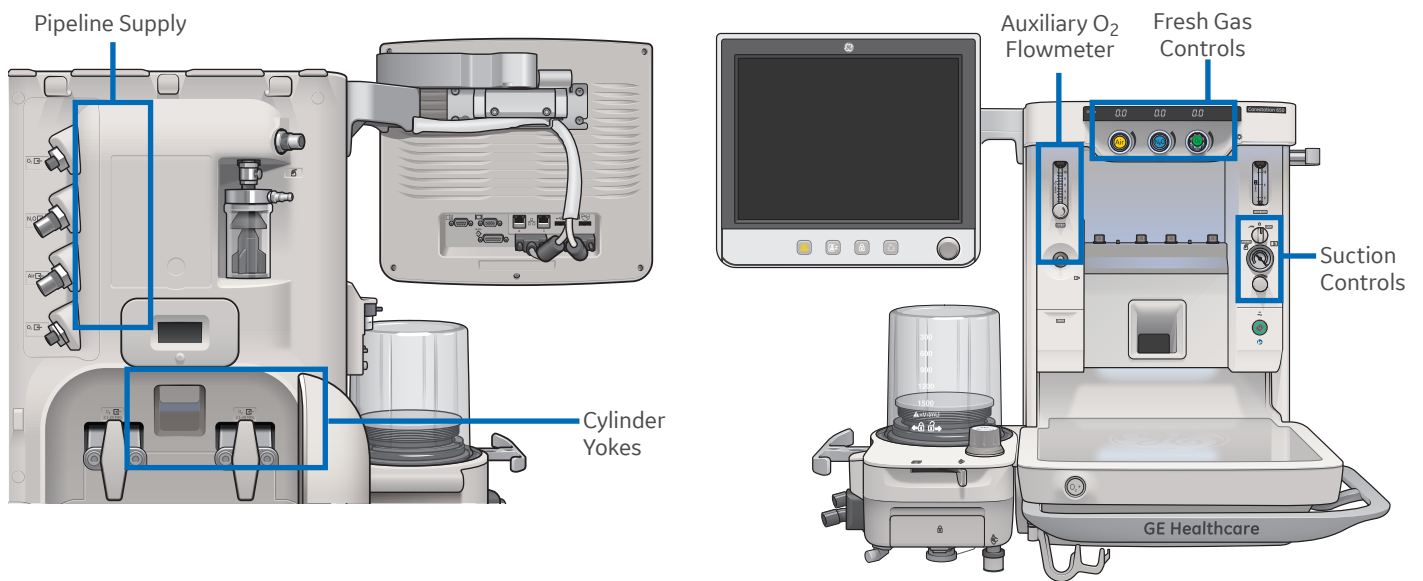

1. Turn on the system.
2. Disconnect pipeline supplies.
3. Turn off the auxiliary O<sub>2</sub> flowmeter and venturi suction. Turn the fresh gas supplies O<sub>2</sub> (N<sub>2</sub>O and Air if present) to minimum flow.
4. Open the cylinder.
5. Observe the cylinder pressure.
6. Close the cylinder. If the cylinder pressure decreases more than 690 kPa (100 psi) in one minute there is a significant leak.
7. To repair a leak, install a new cylinder gasket and tighten the adapter.
8. Repeat the leak test. If the leak continues, do not use the system.



[www.gehealthcare.com](http://www.gehealthcare.com)

GE Healthcare provides transformational medical technologies and services that are shaping a new age of patient care.

Our broad expertise in medical imaging and information technologies, medical diagnostics, patient monitoring systems, drug discovery, biopharmaceutical manufacturing technologies, performance improvement and performance solutions services help our customers to deliver better care to more people around the world at a lower cost.

In addition, we partner with healthcare leaders, striving to leverage the global policy change necessary to implement a successful shift to sustainable healthcare systems.

Carestation, CARESCAPE, D-fend, D-lite, Medisorb, PSVPro, Tec, and Selectatec are trademarks of General Electric Company or one of its subsidiaries.

All other brand names or product names used in this manual are trademarks or registered trademarks of their respective holders.

### **imagination at work**

Product may not be available in all countries and regions. Full product technical specification is available upon request. Contact a GE Healthcare Representative for more information. Please visit [www.gehealthcare.com/promotional-locations](http://www.gehealthcare.com/promotional-locations).

© 2018 General Electric Company – All rights reserved.

General Electric Company reserves the right to make changes in specifications and features shown herein, or discontinue the product described at any time without notice or obligation.

**Notice:** The materials contained in this document are intended for educational purposes only. This document does not establish specifications, operating procedures or maintenance methods for any of the products referenced. Always refer to the official written materials (labeling) provided with the product for specifications, operating procedures and maintenance requirements. Specifications are subject to change.

All patient names or other protected health information or data contained in any image within this material is fictitious. Any similarity to actual persons is coincidental.