

Technical Publications

Direction DOC1998585

Revision 1

Optima/BrightSpeed CT Dicom Conformance Statement for DICOM

- * Refer to section 1 for a list of products in the Optima/BrightSpeed CT families to which this Conformance Statement applies.



Page Left Intentionally Blank

LEGAL NOTES

TRADEMARKS

All products and their name brands are trademarks of their respective holders.

OMISSIONS & ERRORS

Customers, please contact your GE Sales or Service representatives.

GE personnel, please use the GE Healthcare PQR Process to report all omissions, errors, and defects in this publication.

Copyrights

All Material Copyright (c) 2015 by the General Electric Company, All rights reserved.

REVISION HISTORY

| REV. | VER | DATE | REASON FOR CHANGE |
|------|-----|----------------|-------------------|
| 1 | 1 | 31 May 2017 | Initial Draft |

Page Left Intentionally Blank

CONFORMANCE STATEMENT OVERVIEW

This DICOM Conformance Statement captures the DICOM capabilities of the GEHC CT scanners identified below. This document applies to the following software release of the product:

| | |
|--------------------------|----------|
| BrightSpeed Elite | 17BW11.* |
| BrightSpeed Elite Select | 17BW11.* |
| Optima CT540 | 17BW24.* |
| Optima CT520 | 17BW24.* |

Table 0.1 provides an overview of the network services supported by GEHC CT products identified above

Table 0.1 – NETWORK SERVICES

| SOP Classes | User of Service (SCU) | Provider of Service (SCP) |
|--|-----------------------|---------------------------|
| Transfer | | |
| CT Image Storage | Yes | Yes |
| MR Image Storage | Yes | Yes |
| Secondary Capture Image Storage | Yes | Yes |
| Grayscale Softcopy Presentation State Storage | Yes | No |
| Enhanced SR Storage | Yes | Yes |
| X-Ray Radiation Dose SR – CT Radiation Dose | Yes | Yes |
| RT Structure Set Storage | Yes | Yes |
| Positron Emission Tomography Image Storage | Yes | Yes |
| Query/Retrieve | | |
| Study Root Query/Retrieve Information Model – FIND | Yes | Yes |
| Study Root Query/Retrieve Information Model – MOVE | Yes | Yes |
| Print Management | | |
| Basic Grayscale Print Management Meta SOP Class | Yes | No |
| Basic Color Print Management Meta SOP Class | Yes | No |
| Printer SOP Class | Yes | No |
| Workflow Management | | |
| Storage Commitment Push Model SOP Class | Yes | No |
| Modality Performed Procedure Step SOP Class | Yes | No |
| Basic Modality Worklist Information Model – FIND SOP Class | Yes | No |

Table 0.2 provides an overview of the Media Storage Application Profiles supported by the CT products identified above.

Table 0.2 - MEDIA SERVICES

| Media Storage Application Profile | Write Files (FSC or FSU) | Read Files (FSR) |
|-----------------------------------|-----------------------------|---------------------|
| Compact Disk – Recordable | | |
| STD-GEN-CD | Yes / No | Yes |
| DVD | | |
| STD-GEN-DVD-JPEG | Yes / N/A | No |
| USB | | |
| STD-GEN-USB-JPEG | Yes / N/A | Yes |

TABLE OF CONTENTS

| | | |
|----------|--|-----------|
| 1 | INTRODUCTION | 13 |
| 1.1 | OVERVIEW..... | 13 |
| 1.2 | OVERALL CONFORMANCE STATEMENT DOCUMENTATION STRUCTURE | 15 |
| 1.3 | INTENDED AUDIENCE | 16 |
| 1.4 | SCOPE AND FIELD OF APPLICATION..... | 16 |
| 1.5 | IMPORTANT REMARKS..... | 17 |
| 1.6 | REFERENCES..... | 18 |
| 1.7 | DEFINITIONS | 18 |
| 1.8 | SYMBOLS AND ABBREVIATIONS | 20 |
| 2 | NETWORK CONFORMANCE STATEMENT | 21 |
| 2.1 | INTRODUCTION | 21 |
| 2.2 | IMPLEMENTATION MODEL..... | 21 |
| 2.2.1 | <i>Application Data Flow Diagram.....</i> | <i>22</i> |
| 2.2.2 | <i>Functional Definition of AE's.....</i> | <i>26</i> |
| 2.2.3 | <i>Sequencing of Real-World Activities.....</i> | <i>27</i> |
| 2.3 | AE SPECIFICATIONS | 27 |
| 2.3.1 | <i>DICOM Server AE Specification</i> | <i>27</i> |
| 2.4 | COMMUNICATION PROFILES..... | 81 |
| 2.4.1 | <i>Supported Communication Stacks (parts 8).....</i> | <i>81</i> |
| 2.4.2 | <i>TCP/IP Stack.....</i> | <i>81</i> |
| 2.4.3 | <i>Others.....</i> | <i>82</i> |
| 2.5 | EXTENSIONS / SPECIALIZATIONS / PRIVATIZATIONS..... | 82 |
| 2.5.1 | <i>Standard Extended Elements</i> | <i>82</i> |
| 2.5.2 | <i>Private Data Elements</i> | <i>82</i> |
| 2.6 | CONFIGURATION | 82 |
| 2.6.1 | <i>AE Title/Presentation Address Mapping</i> | <i>82</i> |
| 2.6.2 | <i>Configurable Parameters</i> | <i>82</i> |
| 2.7 | SUPPORT OF EXTENDED CHARACTER SETS | 85 |
| 2.8 | CODES AND CONTROLLED TERMINOLOGY | 86 |
| 2.8.1 | <i>Mapped Coded Terminology.....</i> | <i>86</i> |
| 2.9 | SECURITY PROFILES | 86 |
| 3 | MEDIA STORAGE CONFORMANCE STATEMENT | 86 |
| 3.1 | INTRODUCTION | 86 |
| 3.2 | IMPLEMENTATION MODEL..... | 87 |
| 3.2.1 | <i>Application Data Flow Diagram.....</i> | <i>87</i> |
| 3.2.2 | <i>Functional Definitions of AE's</i> | <i>89</i> |
| 3.2.3 | <i>Sequencing of Real World Activities</i> | <i>89</i> |
| 3.2.4 | <i>File Meta Information for Implementation Class and Version.....</i> | <i>89</i> |
| 3.3 | AE SPECIFICATIONS | 89 |
| 3.3.1 | <i>DICOM CD-R/CD-RW/DVD-R/DVD-RW/USB Media Interchange AE Specification..</i> | <i>89</i> |
| 3.4 | AUGMENTED AND PRIVATE APPLICATION PROFILES | 98 |
| 3.4.1 | <i>Augmented Application Profiles</i> | <i>98</i> |
| 3.4.2 | <i>Private Application Profiles</i> | <i>98</i> |
| 3.5 | EXTENSIONS, SPECIALIZATIONS AND PRIVATIZATION OF SOP CLASSES AND TRANSFER SYNTAX | 98 |
| 3.5.1 | <i>Extensions, Specialization's and Privatizations of SOP Classes</i> | <i>98</i> |
| 3.5.2 | <i>Private Transfer Syntax Specification.....</i> | <i>99</i> |

| | | |
|----------|--|------------|
| 3.6 | CONFIGURATION | 99 |
| 3.7 | SUPPORT OF EXTENDED CHARACTER SETS | 99 |
| 3.8 | IHE INTEGRATION..... | 99 |
| 3.8.1 | <i>IHE PDI</i> | 99 |
| 4 | PRINT MANAGEMENT IMPLEMENTATION | 100 |
| 4.1 | INTRODUCTION | 100 |
| 4.2 | BASIC FILM SESSION SOP CLASS | 100 |
| 4.2.1 | <i>Basic Film Session N-Create Attributes</i> | 100 |
| 4.3 | BASIC FILM BOX SOP CLASS | 101 |
| 4.3.1 | <i>Basic Film Box N-Create Attributes</i> | 101 |
| 4.3.2 | <i>Basic Film Box N-Action Attributes</i> | 103 |
| 4.3.3 | <i>Basic Film Box N-Delete</i> | 103 |
| 4.4 | BASIC GRAYSCALE IMAGE BOX SOP CLASS | 103 |
| 4.5 | BASIC COLOR IMAGE BOX SOP CLASS..... | 105 |
| 4.6 | PRINTER SOP CLASS..... | 105 |
| 5 | STORAGE COMMITMENT PUSH MODEL IMPLEMENTATION | 107 |
| 5.1 | STORAGE COMMITMENT PUSH MODEL INFORMATION OBJECT DEFINITION | 107 |
| 5.1.1 | <i>Storage Commitment Module for N-ACTION</i> | 107 |
| 5.1.2 | <i>Storage Commitment Module for N-EVENT-REPORT</i> | 107 |
| 6 | MODALITY WORKLIST QUERY IMPLEMENTATION | 110 |
| 6.1 | MODALITY WORKLIST INFORMATION MODEL DEFINITION | 110 |
| 6.1.1 | <i>Introduction</i> | 110 |
| 6.1.2 | <i>Modality Worklist Information Model Description</i> | 110 |
| 6.1.3 | <i>Modality Worklist Information Model Entity-Relationship Model</i> | 110 |
| 6.1.4 | <i>ModalityWorklist Mapping of DICOM Entities</i> | 112 |
| 6.1.5 | <i>Modality Worklist Information Model Module</i> | 112 |
| 6.1.6 | <i>Information Model Keys</i> | 113 |
| 6.2 | PRIVATE DATA DICTIONARY | 121 |
| 6.3 | C-FIND REQUEST MESSAGE | 122 |
| 6.4 | USE OF SPECIFIC DICOM DATA | 124 |
| 6.5 | SETTING USER PREFERENCES | 126 |
| 6.5.1 | <i>Setting "Use MWL Study UID " Option</i> | 126 |
| 6.5.2 | <i>Setting Custom Query Option</i> | 126 |
| 7 | MODALITY PERFORMED PROCEDURE STEP IMPLEMENTATION..... | 128 |
| 7.1 | INTRODUCTION | 128 |
| 7.2 | N-CREATE & N-SET REQUEST MESSAGE | 128 |
| 7.3 | MODALITY PERFORMED PROCEDURE STEP MODULE DEFINITIONS..... | 130 |
| 7.4 | USE OF SPECIFIC DICOM DATA | 133 |
| 7.4.1 | <i>Patient Level</i> | 133 |
| 7.4.2 | <i>Study Level</i> | 133 |
| 7.4.3 | <i>Series Level</i> | 134 |
| 8 | GRAYSCALE SOFTCOPY PRESENTATION STATE IMPLEMENTATION | 135 |
| 8.1 | INTRODUCTION | 135 |
| 8.2 | CT MAPPING OF DICOM ENTITIES | 135 |
| 8.3 | IOD MODULE TABLE | 135 |
| 8.4 | INFORMATION MODULE DEFINITIONS | 136 |
| 8.4.1 | <i>Patient Entity Module</i> | 136 |
| 8.4.2 | <i>Study Entity Module</i> | 136 |

| | | |
|--------------------|--|------------|
| 8.4.3 | Series Entity Module | 137 |
| 8.4.4 | Equipment Module | 139 |
| 8.4.5 | Presentation State Entity Module..... | 140 |
| 8.5 | IMAGE HEADER CHANGES SUPPORTING GSPS..... | 142 |
| 8.5.1 | Request Attributes Sequence | 142 |
| 8.5.2 | Accession Number..... | 142 |
| 9 | STRUCTURED REPORT INFORMATION OBJECT IMPLEMENTATION | 144 |
| 9.1 | IOD MODULE TABLE | 144 |
| 9.2 | SR DOCUMENT SERIES MODULE | 144 |
| 9.3 | SR DOCUMENT GENERAL MODULE..... | 144 |
| 9.4 | SR DOCUMENT CONTENT MODULE..... | 146 |
| 9.4.1 | TID 10011 – CT Radiation Dose..... | 146 |
| 9.4.2 | TID 10012 – CT Accumulated Dose Data..... | 148 |
| 9.4.3 | TID 10013 – CT Irradiation Event Data..... | 149 |
| 9.5 | CONFIGURATION | 152 |
| 10 | SECURITY CONFORMANCE STATEMENT | 153 |
| 10.1 | DE-IDENTIFICATION | 153 |
| APPENDIX A: | CT IMAGE AND SECONDARY CAPTURE | 156 |
| A.1 | CT IMAGE IOD | 156 |
| A.1.1 | CT Image IOD Modules | 156 |
| A.2 | SC IMAGE IOD | 157 |
| A.2.1 | SC Image IOD Modules | 157 |
| A.2.2 | CT Dose Report SC Image Details..... | 158 |
| A.3 | COMMON MODULES | 160 |
| A.3.1 | Patient Module | 160 |
| A.3.2 | General Study Module | 160 |
| A.3.3 | Patient Study Module..... | 161 |
| A.3.4 | General Series Module | 162 |
| A.3.5 | General Equipment Module | 163 |
| A.3.6 | General Image Module..... | 164 |
| A.3.7 | VOI LUT Module | 165 |
| A.3.8 | SOP Common Module | 165 |
| A.3.9 | Enhanced General Equipment Module..... | 165 |
| A.4 | CT IMAGE MODULES | 166 |
| A.4.1 | Image Plane Module | 166 |
| A.4.2 | Image Pixel Module..... | 166 |
| A.4.3 | Contrast Bolus Module..... | 167 |
| A.4.4 | CT Image Module..... | 167 |
| A.4.5 | Frame of Reference Module | 170 |
| A.4.6 | Other Attributes | 170 |
| A.5 | SC IMAGE MODULES | 171 |
| A.5.1 | SC Equipment Module | 171 |
| A.5.2 | Image Pixel Module..... | 171 |
| A.5.3 | Modality LUT Module | 171 |
| APPENDIX B: | PRIVATE DATA ELEMENTS..... | 172 |
| B.1 | CT IMAGE IOD PRIVATE DATA ELEMENTS DEFINITION | 172 |
| B.1.1 | Private Creator Identification (GEMS_IDEN_01)..... | 172 |
| B.1.2 | Private Creator Identification (GEMS_ACQU_01)..... | 172 |
| B.1.3 | Private Creator Identification (GEMS_RELA_01)..... | 173 |
| B.1.4 | Private Creator Identification (GEMS_STDY_01)..... | 173 |
| B.1.5 | Private Creator Identification (GEMS_IMAG_01)..... | 173 |

| | | |
|--------------------|---|------------|
| B.1.6 | Private Creator Identification (GEMS_0039)..... | 173 |
| B.1.7 | Private Creator Identification (GEMS_CT_FLRO_1)..... | 174 |
| B.1.8 | Private Creator Identification (GEMS_PARM_01)..... | 174 |
| B.1.9 | Private Creator Identification (GEMS_HELIOS_01)..... | 174 |
| B.1.10 | Private Creator Identification (GEMS_CT_CARDIAC_001)..... | 175 |
| B.1.11 | Private Creator Identification (GEHC_CT_ADVAPP_001)..... | 176 |
| APPENDIX C: | DICOMDIR DIRECTORY INFORMATION | 177 |
| C.1 | BASIC DIRECTORY IOD DEFINITION | 177 |
| C.2 | FILE SET IDENTIFICATION MODULE..... | 177 |
| C.3 | DIRECTORY INFORMATION MODULE..... | 177 |
| C.4 | DEFINITION OF SPECIFIC DIRECTORY RECORDS | 178 |
| C.4.1 | Patient Directory Record Definition..... | 178 |
| C.4.2 | Study Directory Record Definition..... | 179 |
| C.4.3 | Series Directory Record Definition..... | 181 |
| C.4.4 | Image Directory Record Definition..... | 183 |
| C.4.5 | Presentation Directory Record Definition..... | 185 |
| C.4.6 | Structured Report Directory Record Definition..... | 187 |
| APPENDIX D: | IMPLEMENTATION UID FOR PRODUCT VERSIONS | 189 |

1 Introduction

Note: Throughout this entire document the term “GEHC CT” refers to the following products:

- BrightSpeed Elite
- BrightSpeed Elite Select
- Optima CT540
- Optima CT520

This document applies to the following software releases for Optima CT Product:

- BrightSpeed Elite 17BW11.*
- BrightSpeed Elite Select 17BW11.*
- Optima CT540 17BW24.*
- Optima CT520 17BW24.*

Note: The GEHC CT product lines present an Image Works desktop, which contains advanced applications offered on the Advantage Workstation. The DICOM Conformance Statements related to these applications can be found at the following website:

http://www3.gehealthcare.com/en/products/interoperability/dicom/computed_tomography_dicom_conformance_statements

| Advanced Application | DICOM Conformance Statement Reference on website |
|---|---|
| Cardiac (Card IQ Xpress Reveal, CardEP) | Volume Viewer and its applications (Release 10.x): Direction # 5404107-100 Rev. 2 |
| CT Perfusion 4D - Neuro and Multi-Organ | Volume Viewer and its Applications (Release 10.x) 5404107-100 Rev. 2 |
| Reformat | Volume Viewer and its Applications (Release 10.x) 5404107-100 Rev. 2 |
| Volume Viewer | Volume Viewer and its Applications (Release 10.x) 5404107-100 Rev. 2 |
| CT_Colono_Pro3D_EC | Volume Viewer and its Applications (Release 10.x) 5404107-100 Rev. 2 |
| AVA_Xpress | Volume Viewer and its Applications (Release 10.x) 5404107-100 Rev. 2 |

1.1 Overview

This DICOM Conformance Statement is divided into Sections as described below:

Section 1 (Introduction), which describes the overall structure, intent, and references for this Conformance Statement.

Section 2 (Network Conformance Statement), which specifies the GEHC CT compliance to the DICOM requirements for the implementation of Networking features.

Section 3 (Media Storage Conformance Statement), which specifies the GEHC CT compliance to the DICOM requirements for the implementation of Media Storage features.

Section 4 (Print Management Implementation), which specifies the GEHC CT compliance to DICOM requirements for the implementation of the Print management service.

Section 5, (Storage Commitment Push Model Implementation), which specifies the GEHC CT compliance to DICOM requirements for the implementation of the Storage Commitment service, to store the images using remote DICOM entity, which is Storage Commitment SCP.

Section 6, (Modality Worklist Query Implementation), which specifies the GEHC CT compliance to DICOM requirements for the implementation of the Modality Worklist service. ModalityWorklist is providing the DICOM C-FIND service as a service class user (SCU).

Section 7, (Modality Performed Procedure Step Implementation), which specifies the GEHC CT compliance to DICOM requirements for the implementation of the Modality Performed Procedure Step service. The PPS option allows a Modality Performed Procedure Step to be communicated to the Hospital/Radiology information system. The PPS feature is providing the DICOM Modality Performed Procedure Step service as a service class user (SCU).

Section 8, (Grayscale Softcopy Presentation State Implementation), which specifies the GEHC CT compliance to DICOM requirements for the implementation of the Grayscale Softcopy Presentation State IOD. The Virtual Exam Split Option for GEHC CT provides the DICOM Modality GSPS service as a service class user (SCU).

Section 9, (Structured Report Information Object Implementation), which specifies the GEHC CT compliance to DICOM requirements for the implementation of the CT X-ray Radiation Dose / Enhanced Structured Report.

Section 10, (Security Conformance Statement), which specifies the de-identification for CT images provided by GEHC CT system.

Appendix A, which specifies the CT IOD and Secondary Capture information object.

Appendix B, which specifies the Private data element definition for CT IOD.

Appendix C, which specifies the DICOMDIR directory information.

Appendix D, which specifies Implementation UIDs for different CT product versions.

1.2 Overall Conformance Statement Documentation Structure

The Documentation Structure of the GEHC DICOM Conformance Statements is shown in the Illustration below.

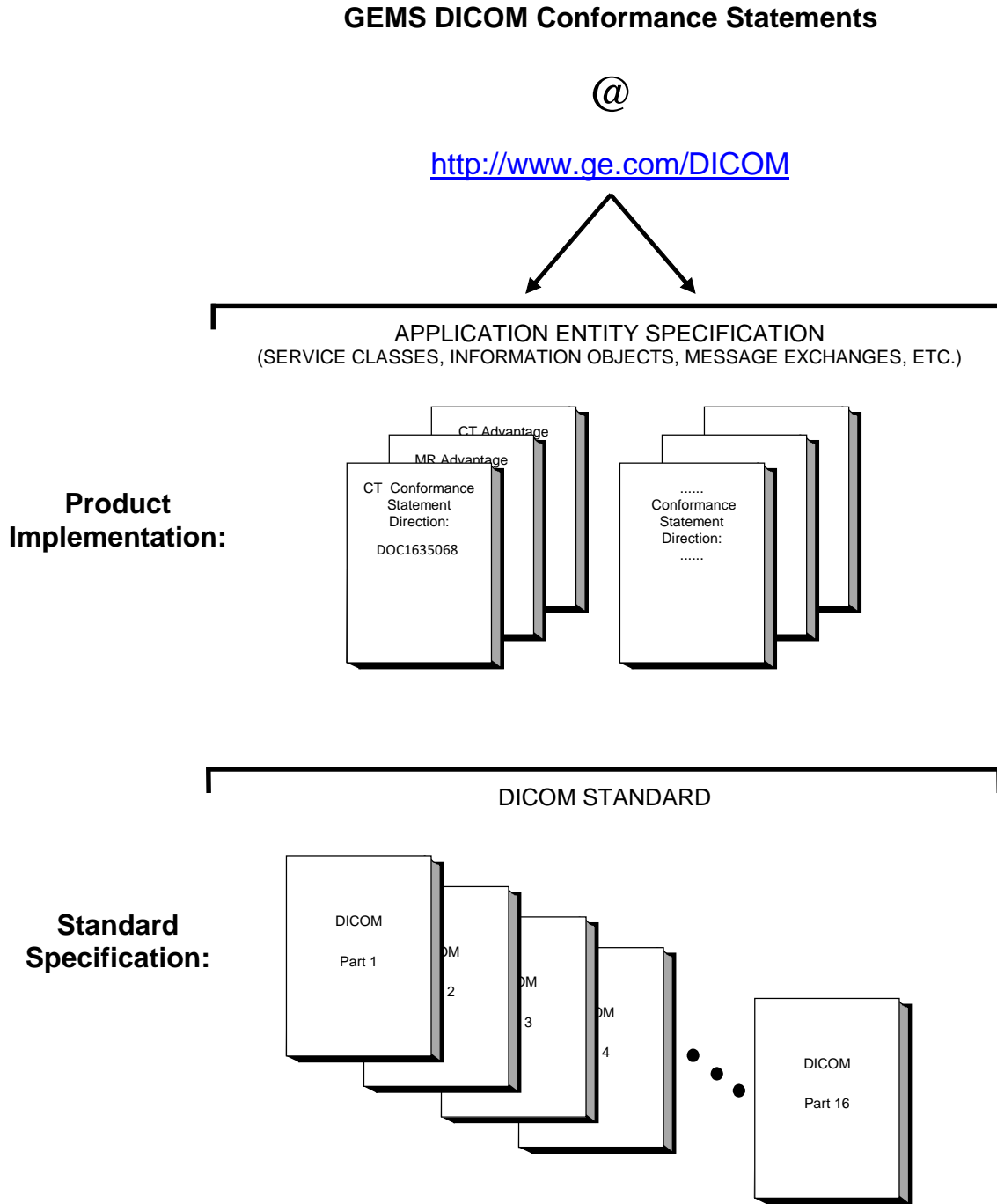

This document specifies the DICOM implementation. It is entitled:

Optima/Brivo CT DICOM Conformance Statement

Conformance Statement for DICOM

Direction DOC1998585

This DICOM Conformance Statement documents the DICOM Conformance Statement and Technical Specification required to interoperate with the GEHC network interface.

The GEHC Conformance Statement, contained in this document, also specifies the Lower Layer communications, which it supports (e.g., TCP/IP). However, the Technical Specifications are defined in the DICOM Part 8 standard.

For more information regarding DICOM, copies of the Standard may be obtained on the Internet at <http://medical.nema.org>. Comments on the Standard may be addressed to:

DICOM Secretariat

NEMA

1300 N. 17th Street, Suite 1752

Rosslyn, VA 22209

USA

Phone : +1.703.841.3200

1.3 Intended Audience

The reader of this document is concerned with software design and/or system integration issues. It is assumed that the reader of this document is familiar with the DICOM Standard and with the terminology and concepts, that are used in that Standard.

1.4 Scope and Field of Application

It is the intent of this document to provide an unambiguous specification for GEHC implementations. This specification, called a Conformance Statement, includes a DICOM Conformance Statement and is necessary to ensure proper processing and interpretation of GEHC medical data exchanged using DICOM. The GEHC Conformance Statements are available to the public.

The reader of this DICOM Conformance Statement should be aware that different GEHC devices are capable of using different Information Object Definitions. For example, a GEHC CT Scanner may send images using the CT Information Object, MR Information Object, Secondary Capture Object, etc.

Included in this DICOM Conformance Statement are the Module Definitions used by this GEHC implementation. If the user encounters unspecified private data elements while parsing a GEHC Data Set, the user is well advised to ignore those data elements (per the DICOM standard). Unspecified private data element information is subject to change without notice. If, however, the device is acting as a "full fidelity storage device", it should retain and re-transmit all of the private data elements that are sent by GEHC devices.

1.5 Important Remarks

The use of these Conformance Statements, in conjunction with the DICOM Standards, is intended to facilitate communication with GE imaging equipment. However, **by itself, it is not sufficient to insure that inter-operation will be successful.** The **user (or user's agent)** needs to proceed with caution and address at least four issues:

- **Integration**

The integration of any device into an overall system of interconnected devices goes beyond the scope of standards (DICOM), and of this introduction and associated Conformance Statements when interoperability with non-GE equipment is desired. The responsibility to analyze the applications requirements and to design a solution that integrates GE imaging equipment with non-GE systems is the **user's** responsibility and should not be underestimated. The **user** is strongly advised to ensure that such integration analysis is correctly performed.

- **Validation**

Testing the complete range of possible interactions between any GE device and non-GE devices, before the connection is declared operational, should not be overlooked. Therefore, the user should ensure that any non-GE provider accepts full responsibility for all validation required for their connection with GE devices. This includes the accuracy of the image data once it has crossed the interface between the GE imaging equipment and the non-GE device and the stability of the image data for the intended applications.

Such a validation is required before any clinical use (diagnosis and/or treatment) is performed. It applies when images acquired on GE imaging equipment are processed/displayed on a non-GE device, as well as when images acquired on non-GE equipment is processed/displayed on a GE console or workstation.

- **Future Evolution**

GE understands that the DICOM Standard will evolve to meet the user's growing requirements. GE is actively involved in the development of the DICOM Standard. DICOM will incorporate new features and technologies and GE may follow the evolution of the Standard. Evolution of the Standard may require changes to devices that have implemented DICOM. In addition, GE reserves the right to discontinue or make changes to the support of communications features (on its products) reflected on by these DICOM Conformance Statements. The user should ensure that any non-GE provider, which connects with GE devices, also plans future evolution of the

DICOM standard. Failure to do so will likely result in the loss of function and/or connectivity as the DICOM Standard changes and GE products are enhanced to support these changes.

- **Interaction**

It is the sole responsibility of the non-GE provider to ensure that communications with the interfaced equipment does not cause degradation of GE imaging equipment performance and/or function.

1.6 References

NEMA PS3 Digital Imaging and Communications in Medicine (DICOM) Standard, available free at <http://medical.nema.org/>

1.7 Definitions

Informal definitions are provided for the following terms used in this Conformance Statement. The DICOM Standard is the authoritative source for formal definitions of these terms.

Abstract Syntax – the information agreed to be exchanged between applications, generally equivalent to a Service/Object Pair (SOP) Class. Examples : Verification SOP Class, Modality Worklist Information Model Find SOP Class, Computed Radiography Image Storage SOP Class.

Application Entity (AE) – an end point of a DICOM information exchange, including the DICOM network or media interface software; i.e., the software that sends or receives DICOM information objects or messages. A single device may have multiple Application Entities.

Application Entity Title – the externally known name of an *Application Entity*, used to identify a DICOM application to other DICOM applications on the network.

Application Context – the specification of the type of communication used between *Application Entities*. Example: DICOM network protocol.

Association – a network communication channel set up between *Application Entities*.

Attribute – a unit of information in an object definition; a data element identified by a *tag*. The information may be a complex data structure (Sequence), itself composed of lower level data elements. Examples: Patient ID (0010,0020), Accession Number (0008,0050), Photometric Interpretation (0028,0004), Procedure Code Sequence (0008,1032).

Information Object Definition (IOD) – the specified set of *Attributes* that comprise a type of data object; does not represent a specific instance of the data object, but rather a class of similar data objects that have the same properties. The *Attributes* may be specified as Mandatory (Type 1), Required but possibly unknown (Type 2), or Optional (Type 3), and there may be conditions associated with the use of an Attribute (Types 1C and 2C). Examples: MR Image IOD, CT Image IOD.

Joint Photographic Experts Group (JPEG) – a set of standardized image compression techniques, available for use by DICOM applications.

Media Application Profile – the specification of DICOM information objects and encoding exchanged on removable media (e.g., CDs)

Module – a set of *Attributes* within an *Information Object Definition* that are logically related to each other. Example: Patient Module includes Patient Name, Patient ID, Patient Birth Date, and Patient Sex.

Negotiation – first phase of *Association* establishment that allows *Application Entities* to agree on the types of data to be exchanged and how that data will be encoded.

Presentation Context – the set of DICOM network services used over an *Association*, as negotiated between *Application Entities*; includes *Abstract Syntaxes* and *Transfer Syntaxes*.

Protocol Data Unit (PDU) – a packet (piece) of a DICOM message sent across the network. Devices must specify the maximum size packet they can receive for DICOM messages.

Security Profile – a set of mechanisms, such as encryption, user authentication, or digital signatures, used by an *Application Entity* to ensure confidentiality, integrity, and/or availability of exchanged DICOM data

Service Class Provider (SCP) – role of an *Application Entity* that provides a DICOM network service; typically, a server that performs operations requested by another *Application Entity* (*Service Class User*). Examples: Picture Archiving and Communication System (image storage SCP, and image query/retrieve SCP), Radiology Information System (modality worklist SCP).

Service Class User (SCU) – role of an *Application Entity* that uses a DICOM network service; typically, a client. Examples: imaging modality (image storage SCU, and modality worklist SCU), imaging workstation (image query/retrieve SCU)

Service/Object Pair (SOP) Class – the specification of the network or media transfer (service) of a particular type of data (object); the fundamental unit of DICOM interoperability specification. Examples: Ultrasound Image Storage Service, Basic Grayscale Print Management.

Service/Object Pair (SOP) Instance – an information object; a specific occurrence of information exchanged in a *SOP Class*. Examples: a specific x-ray image.

Tag – a 32-bit identifier for a data element, represented as a pair of four digit hexadecimal numbers, the “group” and the “element”. If the “group” number is odd, the tag is for a private (manufacturer-specific) data element. Examples: (0010,0020) [Patient ID], (07FE,0010) [Pixel Data], (0019,0210) [private data element]

Transfer Syntax – the encoding used for exchange of DICOM information objects and messages. Examples: *JPEG* compressed (images), little endian explicit value representation.

Unique Identifier (UID) – a globally unique “dotted decimal” string that identifies a specific object or a class of objects; an ISO-8824 Object Identifier. Examples: Study Instance UID, SOP Class UID, SOP Instance UID.

Value Representation (VR) – the format type of an individual DICOM data element, such as text, an integer, a person’s name, or a code. DICOM information objects can be transmitted with either explicit identification of the type of each data element (Explicit VR), or without explicit identification (Implicit VR); with Implicit VR, the receiving application must use a DICOM data dictionary to look up the format of each data

1.8 Symbols and Abbreviations

| | |
|--------|---|
| AE | Application Entity |
| CD-R | Compact Disk Recordable |
| CT | Computed Tomography |
| DICOM | Digital Imaging and Communications in Medicine |
| FSC | File-Set Creator |
| FSU | File-Set Updater |
| FSR | File-Set Reader |
| GSPS | Grayscale Softcopy Presentation State |
| HIS | Hospital Information System |
| IHE | Integrating the Healthcare Enterprise |
| IOD | Information Object Definition |
| JPEG | Joint Photographic Experts Group |
| MPPS | Modality Performed Procedure Step |
| MSPS | Modality Scheduled Procedure Step |
| MTU | Maximum Transmission Unit (IP) |
| MWL | Modality Worklist |
| NTP | Network Time Protocol |
| O | Optional (Key Attribute) |
| PACS | Picture Archiving and Communication System |
| PET | Positron Emission Tomography |
| R | Required (Key Attribute) |
| RIS | Radiology Information System |
| SC | Secondary Capture |
| SCP | Service Class Provider |
| SCU | Service Class User |
| SOP | Service-Object Pair |
| SR | Structured Reporting |
| TCP/IP | Transmission Control Protocol/Internet Protocol |
| U | Unique (Key Attribute) |
| VR | Value Representation |

2 Network Conformance Statement

2.1 Introduction

This Conformance Statement (CS) specifies the GEHC CT compliance to DICOM. It details the DICOM Service Classes and roles that are supported by this product.

The GEHC CT product uses DICOM services to support the following functionalities:

- Import images for possible further analysis and/or processing
- Export images to other DICOM-compliant machines
- Confirm that a DICOM image has been permanently stored (archived) by a device
- Query for and display DICOM modality worklist information from a remote hospital or radiology department information systems
- Communicate Modality Performed Procedure Step to the Hospital/Radiology information systems
- Print images on DICOM Compliant Printers

2.2 Implementation Model

All DICOM functionality on the GEHC CT product is handled by the DICOM Server Application Entity (AE). The DICOM Server AE is commanded to perform DICOM services through the buttons and menu selections on the main user interface panel. The DICOM Server AE is also listening to a pre-defined port for incoming connections.

2.2.1 Application Data Flow Diagram

ILLUSTRATION 2-0
IMPLEMENTATION MODEL DATA FLOW DIAGRAM

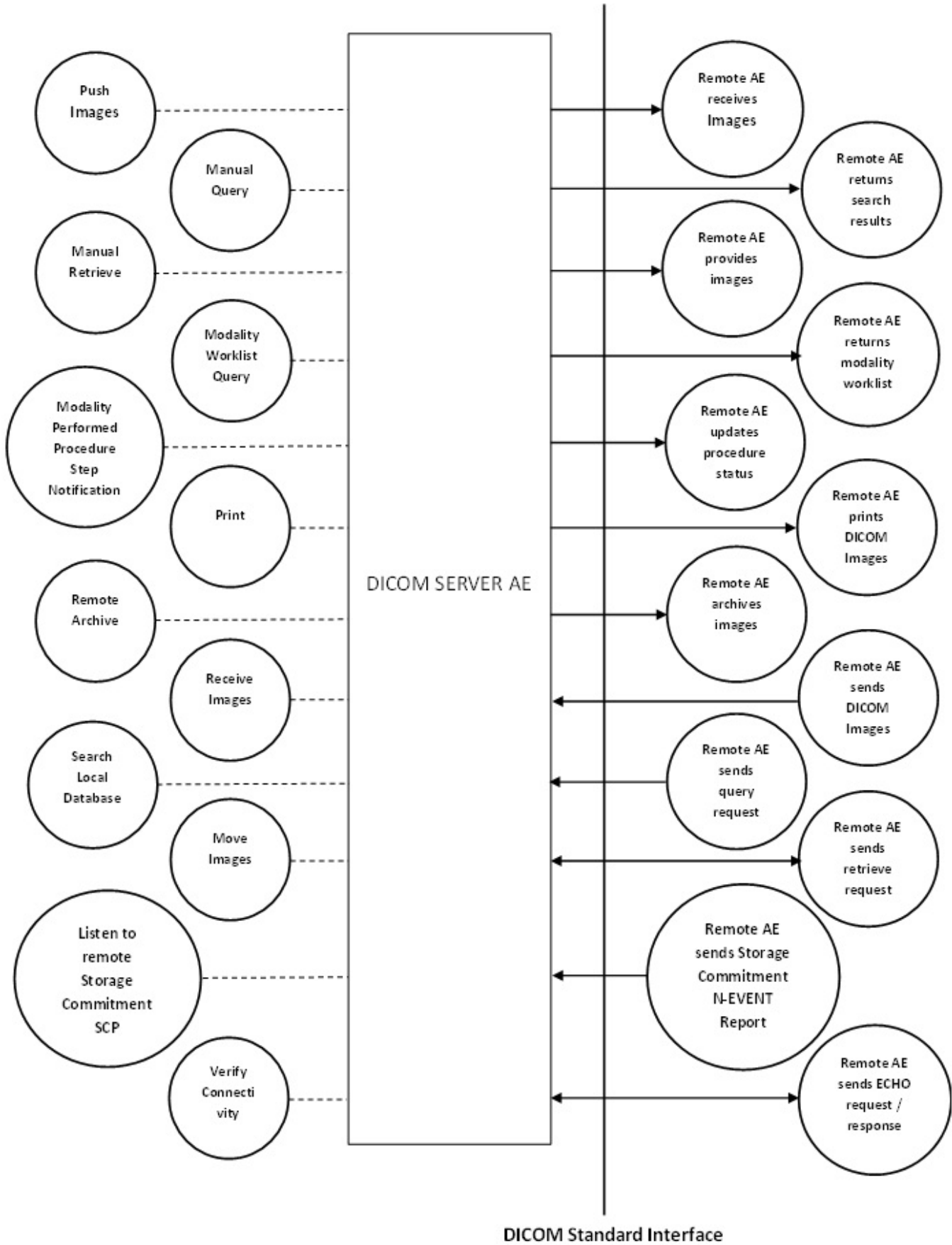

There are several Real-World Activities that will cause the DICOM Server Application Entity (DICOM Server AE) to initiate a DICOM association to a remote DICOM Application Entity. Illustration 2.0 above shows basic Real-World Activities.

The following paragraphs describe the Real-World Activities of Illustration 2.0:

- ***Push Images***

This Real-World Activity consists of an operator selecting one or more studies, series, or images in the local database browser. The operator then clicks on the destination button in the network panel at the bottom of the local database browser to send the image(s) to a selected destination.

- ***Manual Query***

The operator queries one or a set of remote DICOM databases to obtain a list of data at Study/Series/Image level by clicking on the icon that represents the wanted remote DICOM AE.

- ***Manual Retrieve***

This Real-World activity will be available once the *Manual Query* activity is performed. The operator can now select one or more studies (series or images) and ask the DICOM Server AE to retrieve the selected image(s) from the Remote DICOM AE by clicking on the “Local DB” button at the bottom of the local database browser.

- ***Verify Connectivity (DICOM Ping)***

This Real-World activity consists of an operator selecting a Remote DICOM AE from the “Network Configuration” window and clicking on “Ping” on the right side-bar. This is to check the status of the selected remote DICOM AE.

- ***Remote Archive***

This Real-World activity consists of an operator choosing a remote DICOM AE that supports Storage Commitment as provider from the archive panel at the bottom of the local database browser. The operator chooses the exam or series in the local database browser and clicks on the archival destination from the archive list at the bottom of the local database browser.

The Commitment request for the transferred image instances is sent after the complete image transfer. The Commitment response can come on same association or on a different association. Refer to Section 5: **Storage Commitment Push Model Implementation** for details on the Storage Commitment implementation.

- ***Modality Worklist Query***

The operator or the system initiates a modality worklist query to the modality worklist SCP with a given set of query parameters. The modality worklist SCP returns responses matching the query parameters. ~~Worklist items from the returned worklist query responses are presented to the user.~~

The user then chooses the desired worklist item and begins the image acquisition process.

- ***Modality Performed Procedure Step Notification***

When the user begins the image acquisition process and generates the first image, the DICOM SERVER AE sends N-CREATE message to the configured MPPS SCP to indicate that the image acquisition process has been started for the requested procedure.

The operator can close the acquisition session either by completing the acquisition process or discontinuing the ongoing scan. On closing the acquisition session, the DICOM SERVER AE sends N-SET message to the configured MPPS SCP to indicate the acquisition state of the requested procedure, with appropriate MPPS status (COMPLETED/DISCONTINUED).

- ***Print***

The Film Composer allows the operator to select printers and it also allows the user to drag and drop the images (from viewer application) into the film. When user presses the "Print" Button, the DICOM SERVER AE tries to establish the association with requested printer and sends the images for printing.

- ***Receive Images***

When remote DICOM hosts send DICOM images to DICOM SERVER AE, images are installed in the local database. The browser displays the content of the local database.

- ***Image Installation***

The DICOM Server AE will perform this Real-World activity after the remote AE sends an image to the GEHC CT product.

- ***Receive Verification request***

No operator action is required to respond to a verification message. The Real-World Activity associated with the verification request is to send a C-ECHO response message with a status of "success" to the requesting AE.

- ***Search Local Database***

For this operation, a remote DICOM AE asks to obtain the list of data at Study/Series/Image level. Once a Query request is received, the DICOM Server AE will search the local database for all entries that match the keys requested by the Remote DICOM AE and send back the list of matches.

- ***Move Images***

For this operation, a remote DICOM AE asks to send data at Study/Series/Image level from the local AE to another DICOM Remote AE. The Remote DICOM AE shall be declared locally on the system. The declaration of remote DICOM AE is done through a configuration tool.

- ***Listen to remote Storage Commitment SCP***

The DICOM SERVER AE is indefinitely listening for association requests. No operator action is required to receive a Storage Commitment notification (N-EVENT-REPORT).

2.2.2 Functional Definition of AE's

DICOM Server Application Entity initiates the following operations:

- Initiate an association to a Remote AE for the purpose of sending images to the Remote AE. Remote AE accepts the presentation context applicable to the image(s) being sent, the DICOM Server AE will send the image(s) to the receiving Remote AE by invoking the C-STORE-RQ operation for each image on the same association.
- Initiate an association to a Remote AE for the purpose of committing images previously sent successfully to the Remote AE for the purpose of the remote AE to commit to the storage of those images. If the Remote AE accepts the presentation context, a storage commitment will be established with the Remote AE with the DICOM Server AE sending the N-ACTION Request. The Remote AE completes the commitment by sending the N-EVENT REPORT. The DICOM Server AE updates the archive flag in the image browser for successful instances.
- Initiate an association with a Remote AE to query for images on the remote host. A Study-Root Study-Level C-FIND-RQ request will be sent to the Remote AE once an association has been established. Once all the responses have been received, the operator needs to select an exam in the local database browser. On selection of the exam the DICOM Server AE will issue a Series-Level C-FIND-RQ request to get the series for a study in the list. Similarly the Image-Level C-FIND-RQ will be issued for the series selected from the series list.
- Send a C-MOVE-RQ request to a Remote AE for retrieve of images after successful establishment. The DICOM Server AE's Storage SCP will receive the images over a separate association.
- Initiate an association with a Remote AE to verify its status with a C-ECHO-RQ. The Remote AE will report its status in a C-ECHO-RSP
- Initiate an association with a Remote AE to query for and display DICOM modality worklist information. Once the remote AE accepts the presentation context, CT system will issue a modality worklist query request using the C-FIND service
- Initiate an association with a Remote AE to create and update DICOM Modality Performed Procedure Step SOP instance in the remote AE. Once the remote AE accepts the presentation context, SOP instance is created using N-CREATE service and updated using N-SET service.
- Initiates as association with a remote printer for printing the images. If the Remote AE accepts the presentation context applicable to the print job, CT system will send the print job to the receiving remote AE.

The DICOM Server AE waits for association requests from Remote AEs that wish to perform the following operations:

- **Verification:** If a C-ECHO-RQ message is received, the DICOM Server AE will send back a C-ECHO-RSP message with a status of “success”.
- **Image Storage:** If a C-STORE-RQ message is received, the DICOM Server AE will receive the image and try to update the local database. If the image is stored successfully on storage media and the database updated a status of “success” will be returned in a C-STORE-RSP message.
- **Query:** If a C-FIND-RQ message is received the DICOM Server AE will search the database for the requested attributes and send back a C-FIND-RSP message containing a match and a status of “pending”. After all matching records have been sent, a status of “success” will be returned in a C-FIND-RSP message. The Remote AE can terminate the query by sending a C-CANCEL-FIND-RQ message.
- **Retrieve:** If a C-MOVE-RQ message is received the DICOM Server AE will look up its list of configured Remote AEs for the Destination AE. If the Destination AE is configured, the DICOM Server AE will open a new association to the Destination AE and use C-STORE-RQ to send the image(s). The DICOM Server AE will send a C-MOVE-RSP message with a status of “pending” after every five images are sent. When all images are sent or if DICOM Server AE receives a C-CANCEL-MOVE-RQ a final C-STORE-RSP will be sent back with an appropriate status.
- **Storage Commitment Response:** If a N-EVENT-REPORT request is received from the Remote Storage Commitment SCP the DICOM Server AE will update the Archive flag information for successful instances.

2.2.3 Sequencing of Real-World Activities

Real-World Activity *Query Remote* must be performed before *Choose Pull Option* can be performed.

2.3 AE Specifications

2.3.1 DICOM Server AE Specification

This Application Entity provides Standard Conformance to the following DICOM SOP Classes as an SCU:

| SOP Class Name (SCU) | SOP Class UID |
|---|-------------------------------|
| Verification (Echo) | 1.2.840.10008.1.1 |
| CT Image Information Storage | 1.2.840.10008.5.1.4.1.1.2 |
| MR Image Information Storage | 1.2.840.10008.5.1.4.1.1.4 |
| PET Image Information Storage | 1.2.840.10008.5.1.4.1.1.128 |
| RT Structure Set Storage | 1.2.840.10008.5.1.4.1.1.481.3 |
| Secondary Capture Image Storage | 1.2.840.10008.5.1.4.1.1.7 |
| Grayscale Softcopy Presentation State Storage | 1.2.840.10008.5.1.4.1.1.11.1 |
| X-Ray Radiation Dose SR Image Storage | 1.2.840.10008.5.1.4.1.1.88.67 |

| | |
|--|-------------------------------|
| Enhanced SR Storage | 1.2.840.10008.5.1.4.1.1.88.22 |
| Study Root Query/Retrieve – FIND | 1.2.840.10008.5.1.4.1.2.2.1 |
| Study Root Query/Retrieve – MOVE | 1.2.840.10008.5.1.4.1.2.2.2 |
| Storage Commitment Push Model | 1.2.840.10008.1.20.1 |
| Basic Grayscale Print Management Meta SOP class | 1.2.840.10008.5.1.1.9 |
| Basic color print management meta SOP class | 1.2.840.10008.5.1.1.18 |
| Printer SOP Class | 1.2.840.10008.5.1.1.16 |
| Storage Commitment Push Model SOP Class | 1.2.840.10008.1.20.1 |
| Modality Performed Procedure Step SOP Class | 1.2.840.10008.3.1.2.3.3 |
| Basic Modality Worklist Information Model – FIND SOP Class | 1.2.840.10008.5.1.4.31 |

Note: As to GSPS as an SCU, refer to Section 8: **Grayscale Softcopy Presentation State Implementation** for further details.

This Application Entity provides Standard Conformance to the following DICOM SOP classes as an SCP:

| SOP Class Name (SCP) | SOP Class UID |
|---------------------------------------|-------------------------------|
| Verification (Echo) | 1.2.840.10008.1.1 |
| CT Image Information Storage | 1.2.840.10008.5.1.4.1.1.2 |
| MR Image Information Storage | 1.2.840.10008.5.1.4.1.1.4 |
| PET Image Information Storage | 1.2.840.10008.5.1.4.1.1.128 |
| X-Ray Radiation Dose SR Image Storage | 1.2.840.10008.5.1.4.1.1.88.67 |
| RT Structure Set Storage | 1.2.840.10008.5.1.4.1.1.481.3 |
| Secondary Capture Image Storage | 1.2.840.10008.5.1.4.1.1.7 |
| Enhanced SR | 1.2.840.10008.5.1.4.1.1.88.22 |
| Study Root Query/Retrieve – FIND | 1.2.840.10008.5.1.4.1.2.2.1 |
| Study Root Query/Retrieve – MOVE | 1.2.840.10008.5.1.4.1.2.2.2 |

2.3.1.1 Association Establishment Policy

2.3.1.1.1 General

The DICOM Application Context Name (ACN), which is always proposed, is:

| | |
|---------------------------------|------------------------------|
| Application Context Name | 1.2.840.10008.3.1.1.1 |
|---------------------------------|------------------------------|

The Maximum Length PDU negotiation is included in all association establishment requests. The maximum length PDU for association initiated by the DICOM Server AE is:

| | |
|---------------------------|------------------|
| Maximum Length PDU | 64 Kbytes |
|---------------------------|------------------|

SOP class Extended Negotiation is not supported.

The maximum number of Presentation Context Items that is supported is 60. Note that the same Abstract Syntax may be offered multiple times with different Transfer Syntax.

The user information items sent by this product are:

- Maximum PDU Length
- Implementation UID

The table in Appendix D identifies the Implementation UID for this product version.

2.3.1.1.2 Number of Associations

The DICOM Server AE (SCU) will initiate only one DICOM association at a time for each of the following services:

- Push image to a remote host
- Query/Retrieve
- Storage Commitment
- Modality Worklist
- PPS
- Print service

The DICOM Server AE (SCP) can have a maximum of four DICOM associations open simultaneously to Receive and Store image store, N-EVENT-REPORT of Storage Commitment or Respond to an Echo.

2.3.1.1.3 Asynchronous Nature

Asynchronous mode is not supported. All operations will be performed synchronously.

2.3.1.1.4 Implementation Identifying Information

The Implementation UID allows unique identification of a set of products that share the same implementation.

The table in Appendix D identifies the Implementation UID for this product version.

2.3.1.2 Association Initiation by Real-World Activity

2.3.1.2.1 Real World Activity: Push Option

2.3.1.2.1.1 Associated Real-World Activity

The operator must first select the exam/series/image on the local database browser and click on the Remote DICOM AE in the network panel at the bottom of the local database browser to which the operator desires to send the exam/series/image to.

Note: If multiple study, series, or images are chosen to be pushed, one association will be established for each of the studies, series, or images.

2.3.1.2.1.2 Proposed Presentation Contexts

The following table shows the proposed presentation contexts for the DICOM Server AE after Real-World Activity “Push Images” Operation has been performed.

| Presentation Context Table – Proposal | | | | | |
|---------------------------------------|---------------------------------------|--|---|------|----------------------|
| Abstract Syntax | | Transfer Syntax | | Role | Extended Negotiation |
| Name | UID | Name List | UID List | | |
| CT Image Storage | 1.2.840.10008.5.1.4.1 .1.2 | Implicit VR Little Endian Explicit VR Little Endian Explicit VR Big Endian | 1.2.840.10008.1.2 1.2.840.10008.1.2.1 1.2.840.10008.1.2.2 | SCU | None |
| MR Image Storage | 1.2.840.10008.5.1.4.1 .1.4 | Implicit VR Little Endian Explicit VR Little Endian Explicit VR Big Endian | 1.2.840.10008.1.2 1.2.840.10008.1.2.1 1.2.840.10008.1.2.2 | SCU | None |
| PET Image Storage | 1.2.840.10008.5.1.4.1 .1 .128 | Implicit VR Little Endian Explicit VR Little Endian Explicit VR Big Endian | 1.2.840.10008.1.2 1.2.840.10008.1.2.1 1.2.840.10008.1.2.2 | SCU | None |
| RT Structure Set Storage | 1.2.840.10008.5.1.4.1 .1.48 1.3 | Implicit VR Little Endian Explicit VR Little Endian Explicit VR Big Endian | 1.2.840.10008.1.2 1.2.840.10008.1.2.1 1.2.840.10008.1.2.2 | SCU | None |
| Secondary Capture Image Storage | 1.2.840.10008.5.1.4.1 .1.7 | Implicit VR Little Endian Explicit VR Little Endian Explicit VR Big Endian | 1.2.840.10008.1.2 1.2.840.10008.1.2.1 1.2.840.10008.1.2.2 | SCU | None |

| Presentation Context Table – Proposal | | | | | |
|---|--------------------------------------|--|---|------|----------------------|
| Abstract Syntax | | Transfer Syntax | | Role | Extended Negotiation |
| Name | UID | Name List | UID List | | |
| Grayscale Softcopy Presentation State Storage | 1.2.840.10008.5.1.4.1 .1.11 .1 | Implicit VR Little Endian Explicit VR Little Endian Explicit VR Big Endian | 1.2.840.10008.1.2 1.2.840.10008.1.2.1 1.2.840.10008.1.2.2 | SCU | None |
| Enhanced SR | 1.2.840.10008.5.1.4.1 .1.88.22 | Implicit VR Little Endian Explicit VR Little Endian Explicit VR Big Endian | 1.2.840.10008.1.2 1.2.840.10008.1.2.1 1.2.840.10008.1.2.2 | SCU | None |
| X-Ray Radiation Dose SR | 1.2.840.10008.5.1.4.1 .1.88.67 | Implicit VR Little Endian Explicit VR Little Endian Explicit VR Big Endian | 1.2.840.10008.1.2 1.2.840.10008.1.2.1 1.2.840.10008.1.2.2 | SCU | None |

2.3.1.2.1.2.1 SOP Specific Conformance Statement for All Storage SOP Classes

This implementation can perform multiple C-STORE operations over a single association.

Upon receiving a C-STORE confirmation containing a successful status, this implementation will perform the next C-STORE operation. The association will be maintained if possible.

Upon receiving a C-STORE confirmation containing a Refused status, this implementation will terminate the association.

Upon receiving a C-STORE confirmation containing any status that is not Success or Warning, this implementation will consider the current request to be a failure and will terminate the association except if the C-STORE is invoked from a C-MOVE SCP. In this case it will continue to attempt to send the remaining images in the request on the same association.

Following are the status codes that are more specifically processed when receiving messages from Storage SCP equipment:

| Service Status | Status Code | Further Meaning | Application Behavior When Receiving Status Code |
|----------------|-------------|--|---|
| Failure | A700-A7FF | Refused: Out of resources | Error displayed in the Network status and browser job manager queue. |
| | A900-A9FF | Error: Data Set does not match SOP Class | Error displayed in the Network status and browser job manager queue. |
| | C000-CFFF | Error: Cannot Understand | Error displayed in the Network status and browser job manager queue. |
| | 0122 | SOP Class Not Supported | Error displayed in the Network status and browser job manager queue. |
| Warning | B000 | Coercion of Data Elements | Log-files updated |
| | B006 | Elements Discarded | Log-files updated |
| | B007 | Data Set does not match SOP Class | Log-files updated |
| Success | 0000 | | Success status displayed in the Network status and browser job manager queue. |
| * | * | Any other status code | Treated as Failure |

Each C-STORE operation supports an “Association Timer”. This timer starts when the association request is sent or received and stops when the association is established. The time-out is configurable in network-cfg.xml file as **StoreAssociationTimeout**. Default is 60 seconds.

Each C-STORE operation also supports an “Operation Inactivity Timer”. This time-out starts once the first C-STORE request has been issued (on association) or received and is reset each time a C-STORE response has been received or when subsequent C-STORES are sent. This time-out is configurable in networkcfg.xml file as **StoreResponseTimeout**. Default is 5 minutes.

If any of the two timers mentioned above expires, the connection is aborted and the operation is considered as failed.

Note: The time-outs are configurable.

When DICOM Server AE initiates an association to issue a C-STORE, the image will be transmitted by the DICOM Server AE with the same elements as was originally received or created locally (for the standard elements only).

2.3.1.2.1.2.2 SOP Specific Conformance Statement for Grayscale Softcopy Presentation State Storage SOP Class

To create Grayscale Softcopy Presentation State, there are 2 sequences in GEHC CT, Exam Split and Save State

2.3.1.2.1.2.2.1 Exam Split

The Exam Split feature supports two configuration modes of operation. If the other hospital systems support the IHE Radiology Presentation of Performed Procedures (PGP) Profile, the Exam Split feature should be configured as Virtual Exam Split. If the other hospital systems do not support the PGP profile, the Exam Split feature can be configured as Hard Exam Split. Both modes provide the user with the same user interface. The Hard Exam Split mode will create new image series with the images, which should be associated with a selected requested procedure.

This section of the DICOM Conformance Statement specifies the compliance to DICOM conformance requirements for the Grayscale Presentation State (GSPS), used in the Virtual Exam Split mode on this GEHC product. The Virtual Exam Split feature provides the DICOM Modality GSPS service as a service class user (SCU).

The Virtual Exam Split feature works in conjunction with the DICOM Modality Worklist feature and the Modality Performed Procedure Step feature to support the IHE PGP profile as an acquisition modality.

2.3.1.2.1.2.2.1.1 Implementation Model

Virtual Exam Split will create Grayscale Presentation State (GSPS) and Performed Presentation State as defined for the Modality actor in the IHE Radiology Presentation of Grouped Procedures (PGP) Profile.

2.3.1.2.1.2.2.1.2 Application Data Flow Diagram

The basic Application models for the feature are shown in the following illustration:

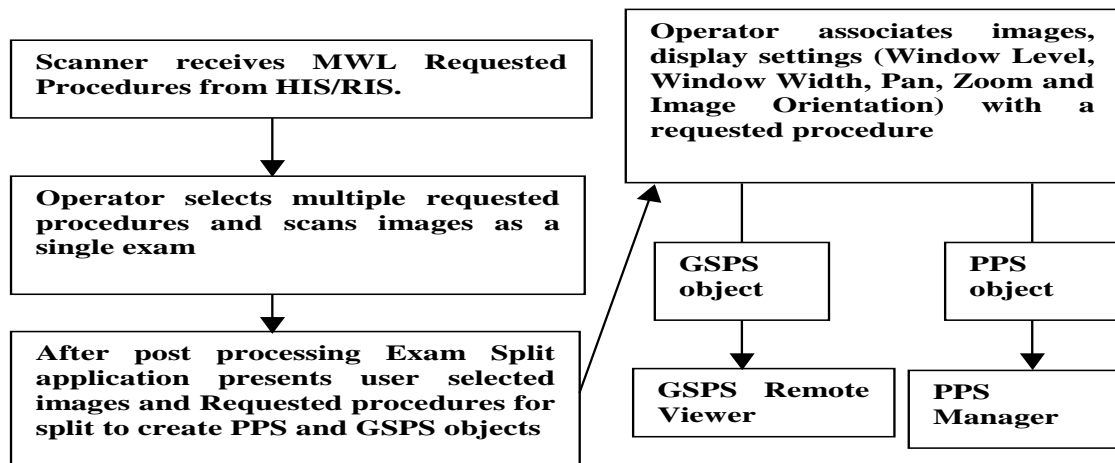

2.3.1.2.1.2.2.1.3 GSPS Acquisition System with MWL data

The system has a Modality Worklist Server AE installed. Worklist information is obtained from HIS/RIS system through the use of Basic Worklist Management Service. Use of the information retrieved in the

creation of Image SOP instance is described in the Modality Worklist Conformance statement. Use of the information retrieved in MPPS SOP instances is described later in this document.

- After Post processing Exam Split application presents associated requested Procedure(s) along with selected acquired Images.
- Exam Split application includes the necessary information related to Requested Procedure, scheduled Procedure Steps and the Performed Procedure Step of the images acquired during acquisition.
- After User modifications on Image(s), user has to click on Send button to create Grayscale Presentation State and Performed Procedure Step objects to transmit to remote host. If there is any Image Orientation, user will be notified about the orientation before sending to Remote Host.
- Exam Split will provide Host Selection user interface to select remote host to transmit of Grayscale Presentation State object. Performed Procedure Step object will be sent to default Performed Procedure Step host.
- After successful transmission of Grayscale Presentation State and Performed Procedure Step objects to remote host, user will be notified with success.

2.3.1.2.1.2.2.2 Save State

2.3.1.2.1.2.2.2.1 Implementation Model

Save State will create Grayscale Presentation State (GSPS) including user annotation.

2.3.1.2.1.2.2.2.2 Application Data Flow Diagram

The basic Application models for the feature are shown in the following illustration:

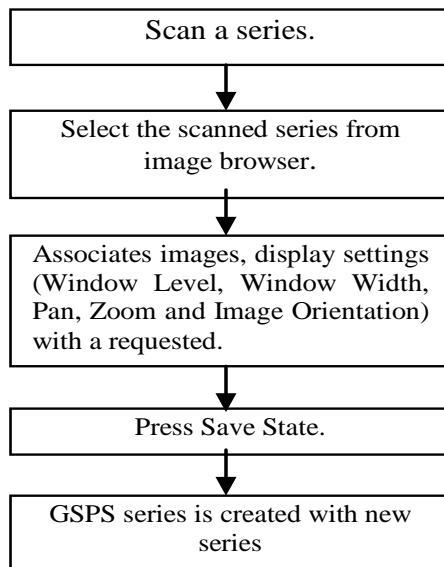

2.3.1.2.1.2.2.2.3 GSPS Acquisition System with MWL data

- Operator takes some scans. After the scan finished, images shall be selected from image browser and select Viewer.
- Operator adds annotation or ROI on images, change WW or WL, zoom or roam images.

- After changing settings, operator shall select “Save State” on Viewer menu. Then, GSPS object shall be created with a new series number.

2.3.1.2.2 Real World Activity: Manual Query

2.3.1.2.2.1 Associated Real-World Activity

The operator must select the Remote DICOM AE from the “Source” pull-down on the local database browser and select the hostname of the source from where the images are to be retrieved.

Provided that the operator had set "Custom search" to "Off" when setting the Remote host parameters, the “Query” operation will cause the DICOM Server AE to initiate an association (with zero length Patient name, Patient id, Study date, Accession number, and Study id) to the selected Remote AE when the “Hostname” entry is selected from the “Source” pull-down menu.

Otherwise, if the operator had set "Custom search" to "On" when setting the Remote host parameters, the “Query” operation will cause a *Customize search parameters* menu to appear. The operator can enter values for Patient name, Patient id, Study date, Accession number, and Study id. Not entering a value means match on any value for that field. Patient name will match on any patient name that contains what the operator entered. Patient id, Study id, and Accession number will match on what the operator enters.

For Study date, the operator selects a range type from the "Exam Date" pull down menu, where the choices are “Equals”, “Before”, “Between”, or “After”. Once a range type is selected, the correct number of fields appears and the operator enters dates into those fields. Once the desired parameters are entered the operator chooses "OK" and that will cause the DICOM Server AE to initiate an association to the selected Remote AE.

Once a list of Study/Series/Image is retrieved, the operator can invoke the “Pull” operation by clicking on the “Local DB” button at the bottom of the local database browser.

2.3.1.2.2.2 Proposed Presentation Contexts

When the Real-World activity “Manual Query” is initiated all presentation contexts shown in the following table are proposed during association establishment, but only the Query/Retrieve-FIND related contexts are applicable to this activity.

| Presentation Context Table – Proposal | | | | | |
|---------------------------------------|-----------------------|---------------------------|-------------------|------|----------------------|
| Abstract Syntax | | Transfer Syntax | | Role | Extended Negotiation |
| Name | UID | Name List | UID List | | |
| Study Root | 1.2.840.10008.5.1.4.1 | Implicit VR Little Endian | 1.2.840.10008.1.2 | SCU | None |
| Query/Retrieve FIND | .2.2.1 | | | | |

| Presentation Context Table – Proposal | | | | | |
|---------------------------------------|-----------------------------|---------------------------|---------------------|------|----------------------|
| Abstract Syntax | | Transfer Syntax | | Role | Extended Negotiation |
| Name | UID | Name List | UID List | | |
| | | Explicit VR Little Endian | 1.2.840.10008.1.2.1 | | |
| | | Explicit VR Big Endian | 1.2.840.10008.1.2.2 | | |
| Study Root Query/Retrieve MOVE | 1.2.840.10008.5.1.4.1.2.2.2 | Implicit VR Little Endian | 1.2.840.10008.1.2 | SCU | None |
| | | Explicit VR Little Endian | 1.2.840.10008.1.2.1 | | |
| | | Explicit VR Big Endian | 1.2.840.10008.1.2.2 | | |

When the Real-World activity “Manual Query” is initiated all presentation contexts shown in the table above are proposed during association establishment, but only the Query/Retrieve-FIND related contexts are applicable to this activity.

2.3.1.2.2.1 SOP Specific Conformance Statement for C-FIND SCU

After the Query operation is initiated, the DICOM Server AE will perform a study-root C-FIND-RQ request at each of the three levels (Study, Series, and Image) in succession.

The Initial Study-Level request will ask for all studies in the Remote database that match the user specified Patient name, Patient Id, Study ID, Accession number, and Study Date. Zero length data in any of those fields means match on any value. Zero length data is the default value if the user does not specify a value.

The user specified Patient name will come surrounded by single asterisks (asterisk is a wild card that matches any number of characters).

Caret (“^”) character cannot be used as a separator of Last name and First name.

The Study date is a range of dates where a *date* is exactly 8 characters long and the format of the range is:

- "" is any date,
- "yyyymmdd-" is any date on or after that year/month/day,
- "-yyyymmdd" is any date on or before that year/month/day,
- "yyyymmdd-yyyymmdd" is any date on or between those dates,
- "yyyymmdd" is only on that date.

The C-FIND SCU will not perform any extended negotiation and so will only perform hierarchical query. Relational Queries are not supported.

Each C-FIND SCU operation supports an “Association Timer” and “Operation Inactivity Timer” using **QueryAssociationTimeout** and **QueryResponseTimeout**, in network-cfg.xml configuration file. Default values are 30 seconds, 5 minutes respectively.

The user can cancel the current C-FIND request by changing the source listing to Local DB or any other remote host. If a query operation is in progress, the DICOM SERVER AE will issue a C-FIND-CANCEL message to the remote AE to discontinue the ongoing C-FIND operation.

If a “Cancel” or “Refused” status is returned from the Remote AE the association is closed and the operation terminated.

The user can cancel the C-FIND request by moving to another network node or clicking on the local database.

The DICOM Server AE will parse each matching C-FIND-RSP reply and ignore the entries that do not contain a valid DICOM data stream. No VR validation is performed which means that syntax errors will be ignored. Tables 2.3.1.2.2.2.1-2 - 2.3.1.2.2.2.1-4 shows the various fields that are requested at the Study, Series, and Image levels of the C-FIND request.

Query results are filtered based on the Modality field. Only CT/MR Screen Save images are supported.

During the C-FIND, the following status values are supported:

- 0xFF00: Study/Series/Image items contained in identifier is collected for later display or further processing and wait for the next response from the remote host.
- 0xFF01: Study/Series/Image items contained in identifier is collected for later display or further processing and wait for the next response from the remote host.

The status codes that are more specifically processed when receiving messages from Query SCP equipment is described in Table 2.3.1.2.2.2.1-1.

Table 2.3.1.2.2.2.1-1 C-FIND Response Status Values

| Service Status | Status Code | Further Meaning | Application Behavior When Receiving Status Code |
|----------------|-------------|--|--|
| Failure | A700 | Refused: Out of resources | Browser displays appropriate error to user |
| | A900 | Error: Identifier does not match SOP Class | Browser displays appropriate error to user |
| | C000-CFFF | Error: Unable to process | Browser displays appropriate error to user |
| Cancel | FE00 | Matching terminated due to cancel | Processed and gracefully exits C-FIND request processing |

| | | | |
|---------|------|--|--|
| Success | 0000 | Matching is complete - No final identifier is supplied | Processed and gracefully exits C-FIND request processing |
| Pending | FF00 | Matches are continuing - Current Match is supplied and any Optional Keys were supported in the same manner as Required Keys. | Processed and the data is displayed in the Browser |
| | FF01 | Matches are continuing - Warning that one or more Optional Keys were not supported for existence for this Identifier | Processed and the data is displayed in the Browser |
| * | * | Any other status code. | Treated as Failure |

The DICOM Server AE will parse each matching C-FIND-RSP reply and ignore the entries it fails to parse. Tables 2.3.1.2.2.2.1-2 - 2.3.1.2.2.2.1-4 shows the various fields that are requested at the Study, Series, and Image levels of the C-FIND request.

Query results are filtered based on the Modality field. Only CT/MR Screen Save images are supported.

Table 2.3.1.2.2.2.1-2: Requested Study Level Keys

| Description | Type | Tag | Value |
|------------------|------|-----------|---|
| Study date | R | 0008,0020 | Zero length for any Study date, or "yyyymmdd-yyyymmdd" matches inclusive range of 'from-to' Study dates. 'From' or 'To' date can be zero length meaning that side of the range is any date. |
| Study time | R | 0008,0030 | Zero length |
| Accession number | R | 0008,0050 | Zero length for any Accession number, or Accession number matches this value |
| Patient's name | R | 0010,0010 | Zero length for any Patient name, or Patient's name matches this value |
| Patient ID | R | 0010,0020 | Zero length for any Patient id, or Patient id matches this value |
| Study id | R | 0020,0010 | Zero length for any Study id, or Study id matches this value |

| Description | Type | Tag | Value |
|--------------------------------|------|-----------|---|
| Study Instance UID | U | 0020,000D | Zero length for Study level query. Study Instance UID of study for which matches are requested at a lower level |
| Study description | O | 0008,1030 | Zero length |
| Private Creator Identification | P | 0009,00xx | GEMS_IDEN_01 |
| Suite Id | P | 0009,xx02 | Zero Length |

Table 2.3.1.2.2.1-3: Requested Series Level Keys

| Description | Type | Tag | Value |
|---------------------|------|-----------|--|
| Modality | R | 0008,0060 | Zero length |
| Series number | R | 0020,0011 | Zero length |
| Series Instance UID | U | 0020,000E | Zero length for Series level query. Series instance UID of series for which matches are requested at a lower level |
| Series description | O | 0008,103E | Zero length |
| Manufacturer | O | 0008,0070 | Zero length |
| Images in series | O | 0020,1002 | Zero length |

Table 2.3.1.2.2.1-4: Requested Image Level Keys

| Description | Type | Tag | Value |
|--------------------------|------|-----------|-------------|
| Image number | R | 0020,0013 | Zero length |
| Image Instance UID | U | 0008,0018 | Zero length |
| Image type | O | 0008,0008 | Zero length |
| Rows | O | 0028,0010 | Zero length |
| Columns | O | 0028,0011 | Zero length |
| Image position | O | 0020,0032 | Zero length |
| Image orientation | O | 0020,0037 | Zero length |
| Slice thickness | O | 0018,0050 | Zero length |
| Slice spacing | O | 0018,0088 | Zero length |
| Gantry tilt | O | 0018,1120 | Zero length |
| Convolution kernel | O | 0018,1210 | Zero length |
| Reconstruction diameter | O | 0018,1100 | Zero length |
| Data collection diameter | O | 0018,0090 | Zero length |
| Flip angle | O | 0018,1314 | Zero length |

| Description | Type | Tag | Value |
|-------------------------------------|------|-----------|--------------|
| Echo number | O | 0018,0086 | Zero length |
| Echo time | O | 0018,0081 | Zero length |
| Inversion time | O | 0018,0082 | Zero length |
| Repetition time | O | 0018,0080 | Zero length |
| Private Creator Identification | P | 0019,00xx | GEMS_ACQU_01 |
| Dfov Rect | P | 0019,xx1E | Zero Length |
| Midscan Time | P | 0019,xx24 | Zero Length |
| Azimuth | P | 0019,xx26 | Zero Length |
| Number of Echo | P | 0019,xx7E | Zero Length |
| Private Creator Identification | P | 0021,00xx | GEMS_RELA_01 |
| Scout Anref | P | 0021,xx4A | Zero Length |
| Private Creator Identification | P | 0027,00xx | GEMS_IMAG_01 |
| Location RAS | P | 0027,xx40 | Zero Length |
| Location | P | 0027,xx41 | Zero Length |
| Center R Coordinate | P | 0027,xx42 | Zero Length |
| Center A Coordinate | P | 0027,xx43 | Zero Length |
| Table Start Location | P | 0027,xx50 | Zero Length |
| Table End Location | P | 0027,xx51 | Zero Length |
| RAS Letter for Side of Image | P | 0027,xx52 | Zero Length |
| RAS Letter for Anterior/Posterior | P | 0027,xx53 | Zero Length |
| RAS Letter for Scout Start Location | P | 0027,xx54 | Zero Length |
| RAS Letter for Scout End Location | P | 0027,xx55 | Zero Length |
| Image Dimension X | P | 0027,xx60 | Zero Length |
| Image Dimension Y | P | 0027,xx61 | Zero Length |

Note1: Refer to section 2.3.1.2.2.1 for Custom Search/Query option.

Note2: Type P refers to a private DICOM element.

2.3.1.2.3 Real World Activity: Manual Retrieve

2.3.1.2.3.1 Associated Real-World Activity

The operator must select the Remote DICOM AE from the “Source” pull-down on the local database browser and select the hostname of the source from where the images are to be retrieved. Once a list of Study/Series/Image is retrieved, the operator can invoke the “Retrieve” operation by clicking on the “Local DB” button at the bottom of the local database browser.

2.3.1.2.3.2 Proposed Presentation Contexts

When the Real-World activity “Manual Retrieve” is initiated all presentation contexts shown in the following table are proposed during association establishment, but only the Query/Retrieve-MOVE related contexts are applicable to this activity.

| Presentation Context Table – Proposal | | | | | |
|---------------------------------------|------------------------------|---------------------------|-------------------|------|----------------------|
| Abstract Syntax | | Transfer Syntax | | Role | Extended Negotiation |
| Name | UID | Name List | UID List | | |
| Study Root Query/Retrieve MOVE | 1.2.840.10008.5.1.4.1 .2.2.2 | Implicit VR Little Endian | 1.2.840.10008.1.2 | SCU | None |
| Study Root Query/Retrieve FIND | 1.2.840.10008.5.1.4.1 .2.2.1 | Implicit VR Little Endian | 1.2.840.10008.1.2 | SCU | None |

2.3.1.2.3.2.1 SOP Specific Conformance Statement for C-MOVE SCU

When the operator starts a *Move* operation at any level (Study, Series, Image) the DICOM Server AE will initiate a C-MOVE-RQ request with UIDs at the appropriate level (Study, Series, Image) to the Remote AE with the DICOM Server AE as the Destination AE. The Storage SCP (“Receive Images”) will handle the incoming images as described in section 2.3.1.3.1.

C-MOVE supports list of Studies (through list of Study UIDs), list of Series (through list of Series UIDs) and list of Images (through list of Instances UIDs).

Each C-MOVE SCU operation supports an “Association Timer” and “Operation Inactivity Timer” with time out values of 30 seconds and 15 seconds respectively.

If the C-MOVE SCU receives a status different from success (0x0000) or pending (0xFF00) during the association, the DICOM SERVER AE will release the association. This information will be logged in the system log files and the network queue will be updated accordingly.

During Manual Retrieve, the DICOM SERVER AE is able to generate a C-MOVE-CANCEL if the operator Pauses or Deletes the retrieve job.

When receiving a Cancel request response (0xFE00), the DICOM SERVER AE will release the association. This information will be logged in the system log files and the network queue will be updated accordingly.

Following are the status codes that are more specifically processed when receiving messages from Retrieve SCP equipment:

| Service Status | Status Code | Further Meaning | Application Behavior When Receiving Status Code |
|----------------|-------------|---|---|
| Failure | A701 | Refused: Out of resources - Unable to calculate number of matches | System will display the message in job manager user interface and retry the operation after configured time is elapsed. |
| | A702 | Refused: Out of resources - Unable to perform sub-operations | System will log the message and retry the operation after configured time is elapsed. |
| | A801 | Refused: Move Destination Unknown | System will display the message in job manager user interface. |
| | A900 | Error: Identifier does not match SOP Class | System will display the message in job manager user interface. |
| | C000-CFFF | Error: Unable to process | System will display the message in job manager user interface. |
| Cancel | FE00 | Sub-operations terminated due to a Cancel indication | Operation will be terminated and the system will display the message in job manager user interface. |
| Warning | B000 | Sub-operations Complete - One or more Failures. | System will log the information. |
| Success | 0000 | Sub-operations Complete - No Failure. | Processed and gracefully exits C-MOVE request processing |
| Pending | FF00 | Sub-operations are continuing - | System processes the information and displays the progress in the job manager UI |
| * | * | Any other status code. | Treated as Failure |

The DICOM Server AE will send a C-CANCEL-MOVE-RQ to the Remote AE if the operator *“Pauses”* or *“Clears”* the job from the local database manager Network queue

2.3.1.2.4 Real-World Activity: Verify (DICOM Ping)

2.3.1.2.4.1 Associated Real-World Activity

The operator shall select a Remote DICOM AE from the *“Network Configuration”* window and click on *“Ping”* on the right side-bar. The DICOM server will initiate an association with the remote DICOM AE in

order to verify communication at the application level. The success or failure of the verification process is displayed to the user.

If the C-ECHO response is received with a success, the DICOM Server will post a pop-up to the operator indicating that the remote device is alive

2.3.1.2.4.2 Proposed Presentation Context Table

Refer to the following table for the Proposed Presentation Contexts for DICOM Server AE and Real-World activity Verification

| Presentation Context Table – Proposal | | | | | |
|---------------------------------------|-------------------|---------------------------|-------------------|------|----------------------|
| Abstract Syntax | | Transfer Syntax | | Role | Extended Negotiation |
| Name | UID | Name List | UID List | | |
| Verification | 1.2.840.10008.1.1 | Implicit VR Little Endian | 1.2.840.10008.1.2 | SCU | None |

2.3.1.2.4.2.1 SOP Specific DICOM Conformance C_ECHO SCU

The GEHC CT DICOM Server AE provides standard conformance to the DICOM Verification Service Class.

Each ECHO operation supports “Association Timer” with **EchoAssociationTimeout**, in network-cfg.xml configuration file. Default values are 20 seconds.

Upon receiving a C-ECHO-RSP, containing a successful status, a message will be posted to the operator indicating success

2.3.1.2.5 Real-World Activity: Remote Archive

2.3.1.2.5.1 Associated Real-World Activity – “Choose Archive Save Option”

The operator must first set remote hosts from Network Configuration from “Tools” pull-down menu. If the remote node is already present, select one remote host, click “Edit” on the right side-bar and make a check on “Archive Node” check box. If the remote host is not present, add the remote host with check on “Archive Node” check box.

Note: The remote node should be a Storage Commitment SCP. STC AE Title can be different from STORE AE title.

The user selects the exam/series to be committed and click on the archival destination from the archive list at the bottom of the local database browser. All the images currently in the selected exam/series

will be sent to the selected remote archive node (which is also the Storage commitment SCP) using DICOM C-STORE operations. Just after all the images are transferred the commitment request will be sent on a separate association.

2.3.1.2.5.2 Associated Real-World Activity – “Auto Archive exam/series”

The Auto archive API’s are used to archive the exams/series onto local archive media or the remote archive node (which shall be a Storage Commitment SCP) without manual interface. If the default device selected for Auto Archive is a remote Storage Commitment SCP then all the images currently in the specified exam/series will be sent to the selected Storage commitment SCP using C-STORE operations. Just after successful transfer of all the images the Storage Commitment request will be sent.

2.3.1.2.5.3 Proposed Presentation Context

The Proposed Presentation Context table for the DICOM Storage Commitment SCU is as shown in following Table.

| Presentation Context Table | | | | | |
|---|----------------------|---------------------------|---------------------|------|-------------|
| Abstract Syntax | | Transfer Syntax | | Role | Extended |
| Name | UID | Name | UID | | Negotiation |
| Storage Commitment Push Model SOP Class | 1.2.840.10008.1.20.1 | Implicit VR Little Endian | 1.2.840.10008.1.2 | SCU | None |
| | | Explicit VR Little Endian | 1.2.840.10008.1.2.1 | | |
| | | Explicit VR Big Endian | 1.2.840.10008.1.2.2 | | |

2.3.1.2.5.3.1 SOP Specific DICOM Conformance Statement for the Storage Commitment Push Model SOP Class SCU (N-ACTION)

The Storage Commitment SCU can send the commitment request for following SOP classes.

| NAME | UID |
|---|-------------------------------|
| CT Image Storage SOP Class | 1.2.840.10008.5.1.4.1.1.2 |
| MR Image storage SOP Class | 1.2.840.10008.5.1.4.1.1.4 |
| PET Image Information Storage | 1.2.840.10008.5.1.4.1.1.128 |
| RT Structure Set Storage | 1.2.840.10008.5.1.4.1.1.481.3 |
| Secondary Capture Storage SOP Class | 1.2.840.10008.5.1.4.1.1.7 |
| Grayscale Softcopy Presentation State Storage SOP Class | 1.2.840.10008.5.1.4.1.1.11.1 |
| Enhanced SR | 1.2.840.10008.5.1.4.1.1.88.22 |
| X-Ray Radiation Dose SR | 1.2.840.10008.5.1.4.1.1.88.67 |

The images in the selected exam/series are sent to the remote commitment provider entity using DICOM C-STORE operations. If there are any failures in the image transfers the Storage commitment request will not be sent. The corresponding job will be marked as failed and user will be notified of the status of job.

If all the images are successfully transferred then the commitment request will be sent on a different association with the list of SOP instances.

If the N-Action request fails, the job will be marked as failed otherwise following sequence of actions will take place.

The SCU waits for N_ACTION response from the provider on the same association for a configurable amount of time. Default time-out is 600 seconds. If it does not receive N_ACTION response during this time it closes the association and marks the job as failed.

If the received N-ACTION Response from the Storage Commitment Provider has a success status, the DICOM SERVER AE waits 10 seconds for an N-EVENT-REPORT on the same association. This time-out is not configurable. If the N-EVENT-REPORT request is not received in this time, it closes the association and changes the Job state to "Waiting" indicating the job is waiting for the response from commitment provider.

The DICOM SERVER AE can receive N-EVENT-REPORT from the Storage Commitment Provider at any time (See section 2.3.1.3.5 - Real-World Activity: Listen to remote Storage Commitment SCP").

A New transaction UID will be created for each retry by user. The old transaction uid is not applicable for these requests.

2.3.1.2.5.3.2 Storage Commitment Push Model SOP Class Request processing

The following DIMSE service Elements are supported for the Storage Commitment request processing.

N-ACTION – Requests the remote Storage Commitment SCP to commit to storing the image instances.

The following attributes are sent as part of the DATA Set for the N-ACTION request.

| Attribute | Tag | Value |
|-------------------------|-------------|-----------------|
| Transaction UID | (0008,1195) | Transaction UID |
| Referenced SOP Sequence | (0008,1199) | |
| SOP Class UID | (0008,1150) | |
| SOP Instance UID | (0008,1155) | |

- Referenced Study Component sequence attribute is not sent.

- Storage Media File-Set ID and Storage Media File-Set UID attributes are not supported.

2.3.1.2.5.3.3 Storage Commitment Push Model SOP Class Response processing

The following DIMSE Service Elements are supported for the Storage Commitment response processing.

N-EVENT-REPORT – The Response sent by the remote Storage Commitment SCP.

Once the N-EVENT REPORT is received, the following actions will be taken depending on the status of the response

2.3.1.2.5.3.3.1 Commit response with SUCCESS status

The Archive flag information in the browser for all the successful instances will be updated. The status will be changed to “Y”.

The job queue entry will be removed

Note: The following attributes are expected as part of DATA Set for N-EVENT-REPORT from SCP

| Attribute | Tag | Value |
|-------------------------|-------------|-------------------------|
| Transaction UID | (0008,1195) | Value received from SCP |
| Referenced SOP Sequence | (0008,1199) | Value received from SCP |
| SOP Class UID | (0008,1150) | Value received from SCP |
| SOP Instance UID | (0008,1155) | Value received from SCP |

N-EVENT-REPORT-RSP will be sent on the same association itself. No DATA Set will be sent along with the response.

2.3.1.2.5.3.3.2 Commit response with FAILURE status

The following attributes are expected as part of DATA Set for N-EVENT-REPORT from SCP:

| Attribute | Tag | Value |
|---------------------|-------------|-------------------------|
| Transaction UID | (0008,1195) | Value received from SCP |
| Failed SOP Sequence | (0008,1198) | Value received from SCP |
| SOP Class UID | (0008,1150) | Value received from SCP |
| SOP Instance UID | (0008,1155) | Value received from SCP |
| Failure Reason | (0008,1197) | Value received from SCP |

In case of complete/partial failure the user will be notified about the status and the job entry will be paused. There is no attempt made to retry automatically the failed SOP instances. However the user can manually retry the failed jobs. Such requests will be treated as new requests. This will go through the whole sequence of operations once again.

The failure reason is ignored.

Failed SOP instances will have their archive flag information unaltered.

Note: The archive status flag in the browser is a shared flag with local archive. When the status is “Y”, it means that the images are archived but doesn’t specify whether on local archive device or remote archive device. It is left to the user’s discretion whether the local SOP instances (with their archive flag set to “Y”) are to be deleted.

N-EVENT-RESPONSE will be sent on the same association itself. No DATA Set will be sent along with the response.

Note: (0008, 1199) Reference SOP Sequence is not handled.

Refer **Section.5 Storage Commitment Push Model Implementation.**

2.3.1.2.6 Real-World Activity: Modality Worklist Query

2.3.1.2.6.1 Associated Real-World Activity

The operator of the system initiates a query for a modality worklist by either opening the Schedule screen or by opening the Schedule screen and pressing the Update button. The choice of which of these two behaviors occurs is user configurable. The Worklist Server will then initiate an association with the remote AE in order to query for the worklist

A user can configure a number of parameters that directly control the worklist query request. The user can request worklist items that are intended for the scanner the user is working at, all items that apply to the modality of the scanner the user is working at or all worklist items available. These selections and their effects on worklist query parameters are given below:

This System:

- Modality, (0008,0060) - set to CT
- Scheduled Station AE Title, (0040,0001) - set to local AE title

All CT Systems:

- Modality, (0008,0060) - set to CT
- Scheduled Station AE Title, (0040,0001) - zero-length (universal matching)

All Systems

- Modality, (0008,0060) - zero-length (universal matching)
- Scheduled Station AE Title, (0040,0001) - zero-length (universal matching)

The scheduled dates of procedures of interest can be specified for query by selecting a specific date range. The date ranges available are Today, Days Before Today, Days After Today and AllDates. These selections and their effects on worklist query parameters are given below:

Today: Scheduled Procedure Step Start Date (0040,0002) - set to YYYYMMDD, where this date is the current date.

Days Before Today and Days After Today: Scheduled Procedure Step Start Date (0040,0002) - set to YYYYMMDD-YYYYMMDD, where this date range represents the specified number of days before today and/or after today. Note that number of days both before and after can be specified in the same query and that each always includes today.

All Dates: Scheduled Procedure Step Start Date (0040,0002) - zero-length (universal matching)

The system also supports a Custom Query option where the user can filter based on Patient Name, Patient ID, Accession Number or Requested Procedure Step ID using a User Interface.

Refer sec 6.5.2 Setting Custom Query Option

2.3.1.2.6.2 Proposed Presentation Context

Below table shows the proposed presentation contexts for the DICOM SERVER AE after real-world activity “Modality Worklist Query” has been initiated:

| Presentation Context Table – Proposed by DICOM SERVER AE for Activity <i>Modality Worklist Query</i> | | | | | |
|---|------------------------|--|---|-------------|-----------------------------|
| Abstract Syntax | | Transfer Syntax | | Role | Extended Negotiation |
| Name | UID | Name List | UID List | | |
| Modality Worklist Information Model – FIND | 1.2.840.10008.5.1.4.31 | Implicit VR Little Endian Explicit VR Little Endian Explicit VR Big Endian | 1.2.840.10008.1.2 1.2.840.10008.1.2.1 1.2.840.10008.1.2.2 | SCU | None |

2.3.1.2.6.2.1 SOP Specific DICOM Conformance Statement for the Modality Worklist Information Model FIND SOP Class

If the remote AE does not support the proposed Presentation Context, an appropriate error is logged and the operator is notified.

This implementation can receive multiple C-FIND results over a single association. Only one association is opened at a time.

Each C-FIND response received from the remote AE is parsed to verify the length/type of the items in the response. Upon detecting any error in the response data, the response is discarded and the next response (if any) is considered.

Each C-FIND SCU operation supports an “Association Timer” and “Operation Inactivity Timer” using QueryAssociationTimeout and QueryResponseTimeout configuration parameters. Default values are 30 seconds, 5 minutes respectively.

All errors and failures detected by the DICOM SERVER AE are logged to the service log files.

In case of ERROR, persisted worklist item(s) got from previous request to the configured SCP would be shown.

User can cancel the ongoing worklist query by clicking on the Cancel button in the UI. Upon cancel, the DICOM SERVER AE will send C-FIND-CANCEL request to the Modality Worklist SCP.

Following are the status codes that are more specifically processed when receiving messages from a **Modality Worklist** SCP equipment :

| Service Status | Status Code | Further Meaning | Application Behavior When Receiving Status Code |
|----------------|-------------|--|---|
| Failure | A700 | Refused: Out of resources | Logs the error and displays all the persisted worklists |
| | A900 | Error: Identifier does not match SOP Class | Logs the error and displays all the persisted worklists |
| | C001 | Error: Unable to process | Logs the error and displays all the persisted worklists |
| Cancel | FE00 | Matching terminated due to cancel | Closes the association |
| Success | 0000 | Matching is complete - No final identifier is supplied | Displays all the worklists items obtained from the SCP |
| Pending | FF00 | Matches are continuing - Current Match is supplied and any Optional Keys were supported in the same manner as Required Keys. | Continue to wait for worklists items from SCP |
| | FF01 | Matches are continuing - Warning that one or more Optional Keys were not supported for existence for this Identifier | Continue to wait for worklists items from SCP |
| * | * | Any other status code. | Worklist query operation is considered as failure and the error message is displayed to the user. Persisted worklist item(s) got from previous request to the SCP will be shown |

2.3.1.2.6.2.2 Record Acceptance Policy

The GEHC CT implementation adheres to strict value checking of incoming query responses from the remote AE. Each response received is examined to verify that all Type 1 attributes are present with non-zero length, that all Type 2 attributes are present (possibly with zero length) and that the data for all attributes is consistent with respect to the attributes' value representation (VR).

Any inconsistencies in the response data, with respect to the categories described above, are considered errors. Upon detecting any such errors in the response data, the Worklist Server AE will issue a C-FIND-CANCEL and, upon receipt of a C-FIND-RSP (or if an applicable timer expires), will abort the association. All previously received worklist items are retained. Note that the absence of requested Type 3 attributes is not considered an error.

Fields considered Type 1 by the Worklist Server include:

- (0010,0010), Patient Name
- (0010,0020), Patient ID
- (0020,000D), Study Instance UID
- (0040,0001), Scheduled Station AE Title
- (0040,0002), Scheduled Procedure Step Start Date ¹
- (0040,0003), Scheduled Procedure Step Start Time ¹
- (0040,0009), Scheduled Procedure Step ID
- (0040,1001), Requested Procedure ID

¹ Start Date must be of the form YYYYMMDD, exactly eight numeric characters, and Start Time must be of the form HHMMSS, exactly six numeric characters.

Fields considered Type 2 by Worklist Server include:

- (0008,0050), Accession Number
- (0008,0060), Modality
- (0008,0090), Referring Physician Name
- (0010,0030), Patient Date of Birth
- (0010,0040), Patient Sex
- (0010,1030), Patient Weight in kg
- (0010,2000), Medical Alerts
- (0010,2110), Contrast Allergies
- (0010,21C0), Pregnancy Status
- (0032,1032), Requesting Physician
- (0032,1070), Requested Contrast Agent
- (0038,0010), Admission ID
- (0038,0050), Special Needs
- (0038,0300), Current Patient Location
- (0038,0500), Patient State
- (0040,0006), Performing Physician
- (0040,0010), Scheduled Station Name
- (0040,0011), Scheduled Procedure Step Location

- (0040,0012), Pre-order Medication
- (0040,1003), Requested Procedure Priority
- (0040,1004), Patient Transport Arrangements
- (0040,3001), Confidentiality Constraint

Refer **Section.6 Modality Worklist Query Implementation.**

2.3.1.2.7 Real-World Activity: Modality Performed Procedure Step Notification

The PPS Server AE is implemented as an application process on the scanner host computer. It runs as a daemon serving requests from other applications to send the PPS information to the remote AE and return the results to the requesting application.

The PPS Server AE initiates the following functions.

- **Start PPS:** Initiates a DICOM association in order to create a DICOM Modality Performed Procedure Step SOP instance in the remote AE. If the remote AE accepts a presentation context applicable to Modality performed Procedure Step, the PPS Server AE will issue a request to create the SOP instance in the remote AE via the N-CREATE service.
- **Complete PPS:** Initiates a DICOM association in order to update a DICOM Modality Performed Step instance that is already created with the remote AE. If the remote AE accepts a presentation context applicable to Modality performed Procedure Step, the PPS Server AE will issue a request to update the SOP instance in the remote AE via the N-SET service. The PPS Status is set to 'COMPLETED'.
- **Discontinue PPS:** Initiates a DICOM association in order to update a DICOM Modality Performed Step instance that is already created with the remote AE. If the remote AE accepts a presentation context applicable to Modality performed Procedure Step, the PPS Server AE will issue a request to update the SOP instance in the remote AE via the N-SET service. The PPS Status is set to 'DISCONTINUED'

2.3.1.2.7.1 Associated Real-World Activity

The real-world activities are described in the following sections. Each of the real world activity results in either creating a new Performed Procedure Step SOP instance at the remote SCP or updating an already created Performed Procedure Step SOP instance as per the DICOM standard.

2.3.1.2.7.1.1 Sequencing of Real-World Activities

2.3.1.2.7.1.1.1 PPS from Acquisition System with MWL data

The system has a Modality Worklist Server AE installed. Worklist information is obtained from HIS/RIS system through the use of Basic Worklist Management Service. Use of the information retrieved in the creation of Image SOP instance is described in the Modality Worklist Conformance

statement. Use of the information retrieved in MPPS SOP instances is described later in this document.

- The system initiates a 'Start PPS' after the first image is acquired into the database. The system retrieves necessary information related to the Scheduled Procedure Step from Modality Worklist Server. PPS Server AE initiates a MPPS (Modality Performed Procedure Step) N-CREATE request to the remote AE (MPPS SCP), in-order to create a MPPS SOP instance at the remote AE.
- The MPPS SCP returns response indicating the success/failure of the request execution. The PPS state information is updated in the system based on the response data, and is presented to the user. ***The DICOM association is closed.***
- System includes the necessary information related to Scheduled Procedure Steps and the Performed procedure Step in the image instances created.
- At the end of image acquisition, system initiates a 'Complete PPS' or 'Discontinue PPS' based on the choice selected by the user using the user interface provided. The user is also given a choice 'Defer PPS' which is described below. PPS Server AE initiates a MPPS N-SET request to the remote AE, in-order to update the MPPS SOP instance that is already created. **The N-SET is sent over a new DICOM association**
- At the end of image acquisition, if the user has chosen 'Defer PPS', the user is provided with an interface to 'Complete PPS' or 'Discontinue PPS' at any later time. The user might wish to alter the image set generated through acquisition, before invoking these operations. Note that the user explicitly uses the user interface provided to invoke this operation, as in the case of PPS generated for post-processing, which is described in the following section. **PPS messages N-CREATE (if applicable) and N-SET will be sent over the same DICOM association**
- The remote AE returns response indicating the success/failure of the request execution. The PPS state information is updated in the system based on the response data, and is presented to the user.

2.3.1.2.7.1.1.2 PPS from acquisition system without MWL data

The system either does not have a Modality Worklist Server AE installed or a Modality Worklist Server AE installed but no Worklist information is obtained from HIS/RIS system for the current procedure that is being performed. The information required for performing the procedure is supplied through the user interface of the system. The use of this information in MPPS SOP instances is described later in this document.

- The system initiates a 'Start PPS' after the first image is acquired into the database. PPS Server AE initiates a MPPS (Modality Performed Procedure Step) N-CREATE request to the remote AE (MPPS SCP), in-order to create a MPPS SOP instance at the remote AE.
- The MPPS SCP returns response indicating the success/failure of the request execution. The PPS state information is updated in the system based on the response data, and is presented to the user. ***The DICOM association is closed.***

- System includes the necessary information related to Scheduled Procedure Steps and the Performed procedure Step in the image instances created.
- At the end of image acquisition, system initiates a ‘Complete PPS’ or ‘Discontinue PPS’ based on the choice selected by the user using the user interface provided. The user is also given a choice ‘Defer PPS’ which is described below. PPS Server AE initiates a MPPS N-SET request to the remote AE, in-order to update the MPPS SOP instance that is already created.
- At the end of image acquisition, if the user has chosen ‘Defer PPS’, the user is provided with an interface to ‘Complete PPS’ or ‘Discontinue PPS’ at any later time. The user might wish to alter the image set generated through acquisition, before invoking these operations. Note that the user explicitly uses the user interface provided to invoke this operation, as in the case of PPS generated for post-processing, which is described in the following section.
- The remote AE returns response indicating the success/failure of the request execution. The PPS state information is updated in the system based on the response data, and is presented to the user.

2.3.1.2.7.1.1.3 PPS from post-processing system

- The user initiates post-processing on the images generated through acquisition.
- The system creates a Modality Performed Procedure Step instance locally in the system. If the source image instance has the Scheduled Procedure Step information, it is copied into the image instances created. Also the system includes the necessary information related to the Modality Performed Procedure Step into the image instance.
- At the end of (one or more) post-processing, the user initiates ‘Complete PPS’ or ‘Discontinue PPS’ through the user interface provided. PPS Server AE initiates a MPPS (Modality Performed Procedure Step) N-CREATE request to the remote AE (MPPS SCP), in-order to create a MPPS SOP instance at the remote AE (which is actually a replica of the locally created MPPS SOP instance).
- The remote AE returns response indicating the success/failure of the request execution. If the response indicates success, PPS Server AE initiates a MPPS N-SET request to the remote AE, in-order to update the MPPS SOP instance that is already created, with the additional information.
- The remote AE returns response indicating the success/failure of the request execution. The PPS state information is updated in the system based on the response data, and is presented to the user.

2.3.1.2.7.2 Proposed Presentation Context

| Presentation Context Table – Proposed by DICOM SERVER AE for Activity <i>Modality Performed Procedure Step Notification</i> | | | |
|--|------------------------|-------------|-----------------|
| Abstract Syntax | Transfer Syntax | Role | Extended |
| | | | |

| Name | UID | Name List | UID List | | Negotiation |
|-----------------------------------|-------------------------|---------------------------|---------------------|-----|-------------|
| Modality Performed Procedure Step | 1.2.840.10008.3.1.2.3.3 | Implicit VR Little Endian | 1.2.840.10008.1.2 | SCU | None |
| | | Explicit VR Little Endian | 1.2.840.10008.1.2.1 | | |
| | | Explicit VR Big Endian | 1.2.840.10008.1.2.2 | | |

2.3.1.2.7.2.1 SOP Specific DICOM Conformance Statement for MPPS SOP class

Only one association is opened at a time. The association is open until the response message is returned from the SCP or a network error occurs. No other configurable timers are available.

If the remote AE does not support the proposed Presentation context, an appropriate error message is logged.

Following are the status codes that are more specifically processed when receiving an N-CREATE and N-SET response from an **MPPS SCP** equipment:

| Service Status | Status Code | Further Meaning | Application Behavior When Receiving Status Code |
|----------------|----------------------|---|---|
| Success | 0000 | Success | System updates the state and indicates the same on the user interface |
| Failure | 0105 | No such attribute | Error message is logged into system log-file and indicates the status on the user interface |
| | 0106 | Invalid attribute value | Error message is logged into system log-file and indicates the status on the user interface |
| | 0110 | Processing failure | Error message is logged into system log-file and indicates the status on the user interface. Retries the operation after the configured time is elapsed |
| | 0112 | No such SOP Instance | Error message is logged into system log-file and indicates the status on the user interface |
| | 0115 | Invalid argument value | Error message is logged into system log-file and indicates the status on the user interface |
| | 0117 | Invalid SOP Instance | Error message is logged into system log-file and indicates the status on the user interface |
| | 0118 | No such SOP Class | Error message is logged into system log-file and indicates the status on the user interface |
| | 0119 | Class-instance conflict | Error message is logged into system log-file and indicates the status on the user interface |
| | 0120 | Missing attribute | Error message is logged into system log-file and indicates the status on the user interface |
| | 0144 | No such argument | Error message is logged into system log-file and indicates the status on the user interface |
| 0210 | Duplicate invocation | Error message is logged into system log-file and indicates the status on the user interface | |

| | | | |
|---|------|------------------------|--|
| | 0211 | Unrecognized operation | Error message is logged into system log-file and indicates the status on the user interface |
| | 0212 | Mistyped argument | Error message is logged into system log-file and indicates the status on the user interface |
| | 0213 | Resource limitation | Error message is logged into system log-file and indicates the status on the user interface. Retries the operation after the configured time is elapsed |
| | C002 | Operation failed | Error message is logged into system log-file and indicates the status on the user interface. Retries the operation after the configured time is elapsed |
| * | * | Any other status code. | The operation is deemed 'Failed'. Detailed message is logged into system log-file and indicates the status on the user interface. Retries the operation after the configured time is elapsed |

Refer **Section.7 Modality Performed Procedure Step Implementation.**

2.3.1.2.8 Real-World Activity: Print

2.3.1.2.8.1 Associated Real-World Activity

The Film Composer allows the user to select printers and it also allows the user to drag and drop the images (from the viewer application) into the film. It also allows the user to manipulate some print parameters like film format and number of copies to print. When the user presses the "Print" Button, the Film composer communicates this request to Print SCU, which then tries to establish the association with the requested printer and transmits the images for printing.

2.3.1.2.8.1.1 Sequencing of Real-World Activities

- The DICOM printer is installed through a camera installation process. The DICOM printer is selected from the Film Composer Interface for Manual Filming. Autofilming is enabled using the camera setup via the camera installation process.
- Images may be acquired for printing in the following manner:
 - Images to be printed may be manually dropped from Viewing applications into the manual film composer slots.
 - Images to be printed may be automatically dropped from Viewing applications into the manual film composer slots.
 - Images to be printed may be manually dropped from Viewing applications into the auto film composer slots.

- Image series to be printed may be automatically dropped from the Print Series application into the manual film composer slots.
- Images to be printed may be automatically dropped from the Scanning Application into the auto film composer slots.
- Based upon the filming mode (and the attributes) used to acquire images into the film composer, films will be automatically printed when the film session is full, or the user must press the Print Button to print the images.
- The Print SCU will start the Print Session. The Print Session involves establishing association with the printer followed by the next sequence of activities:
 - The Print SCU gets the Print SCP status using **N-GET** service. If the Printer returns FAILURE status the print session will be terminated and the requester will be notified of the printer status.
 - The film session is created using **N-CREATE** service. In case of error, the print session will be terminated. The attribute values for the Film session will be specified with the film session request.
 - The film box is created using **N-CREATE** service. The print session will be terminated if the printer fails to create the film box. The film box attribute values will be sent in the film box create request
 - The image attributes for the images to be printed in this session will be set using the **N-SET** service. If the printer fails to accommodate the images in the image set, the print session will be terminated. The film will be printed using the **N-ACTION** service. Only film box printing is supported. In case of error, the print session will be terminated.
 - The Film Box instance will be deleted using the **N-DELETE** service.
 - The SCU does not wait for **N-EVENT-REPORT** from the Printer after deleting the film box instance. The **N-EVENT-REPORT** received when the association was still active is handled, but the data received will be ignored.
 - Finally the association will be terminated and if all the above operations are successful the requester will be notified of the successful print session. This status just indicates that the images to be printed have been successfully sent to the printer.

2.3.1.2.8.2 Proposed Presentation Context

The Proposed Presentation Context Table for the Print SCU is as shown in following Table.

Table 2.3.1.2.8.2-1 Presentation Context– Proposed by DICOM SERVER AE for Activity Print

| |
|---------------------------------------|
| Presentation Context Table – Proposed |
|---------------------------------------|

| Abstract Syntax | | Transfer Syntax | | Role | Extended Negotiation |
|---|------------------------|---------------------------|---------------------|------|----------------------|
| Name | SOP CLASS UID | Name | UID | | |
| Basic Grayscale Print Management Meta SOP Class | 1.2.840.10008.5.1.1.9 | Implicit VR Little Endian | 1.2.840.10008.1.2 | SCU | None |
| | | Explicit VR Little Endian | 1.2.840.10008.1.2.1 | | |
| | | Explicit VR Big Endian | 1.2.840.10008.1.2.2 | | |
| Basic Color Print Management Meta SOP Class | 1.2.840.10008.5.1.1.18 | Implicit VR Little Endian | 1.2.840.10008.1.2 | SCU | None |
| | | Explicit VR Little Endian | 1.2.840.10008.1.2.1 | | |
| | | Explicit VR Big Endian | 1.2.840.10008.1.2.2 | | |
| Printer SOP Class | 1.2.840.10008.5.1.1.16 | Implicit VR Little Endian | 1.2.840.10008.1.2 | SCU | None |
| | | Explicit VR Little Endian | 1.2.840.10008.1.2.1 | | |
| | | Explicit VR Big Endian | 1.2.840.10008.1.2.2 | | |

Note:

Support of the Basic Grayscale Print Management Meta SOP Class as an SCU mandates support for the Basic Film Session, Basic Film Box, Basic Grayscale Image Box, and Printer SOP Classes as an SCU.

Support of the Basic Color Print Management Meta SOP Class as an SCU mandates support for the Basic Film Session, Basic Film Box, Basic Color Image Box, and Printer SOP Classes as an SCU.

2.3.1.2.8.2.1 SOP Specific DICOM Conformance Statement for Basic Grayscale and Color Print Management SOP Classes

The DICOM SERVER AE uses the following DIMSE services of the supported SOP Classes for Activity Print:

Table 2.3.1.2.8.2.1-1 DIMSE Services used by DICOM SERVER AE for Activity Print

| SOP Class | SOP Class UID | DIMSE Service Element | SCU Usage |
|----------------------------------|-------------------------|-----------------------|------------------|
| Basic Film Session | 1.2.840.10008.5.1.1.1 | N-CREATE | Used (Mandatory) |
| | | N-SET | Not Used |
| | | N-DELETE | Not Used |
| | | N-ACTION | Not Used |
| Basic Film Box | 1.2.840.10008.5.1.1.2 | N-CREATE | Used (Mandatory) |
| | | N-ACTION | Used (Mandatory) |
| | | N-DELETE | Used |
| | | N-SET | Not Used |
| Basic Grayscale Image Box | 1.2.840.10008.5.1.1.4 | N-SET | Used (Mandatory) |
| Basic Color Image Box | 1.2.840.10008.5.1.1.4.1 | N-SET | Used (Mandatory) |
| Printer | 1.2.840.10008.5.1.1.16 | N-EVENT-REPORT | Used (Mandatory) |
| | | N-GET | Used |

2.3.1.2.8.2.1.1 Basic Film Session SOP Class

The DICOM SERVER AE supports the following DIMSE Service Elements for the Basic Film Session SOP Class.

- N-CREATE - Requests the Print SCP to create an instance of Basic Film Session.

Only one association is opened at a time. The association is open until the response message is returned from the SCP or a network error occurs. No other configurable timers are available.

Following are the status codes that are more specifically processed when receiving messages from a Print SCP equipment for the Basic Film Session SOP Class N-CREATE:

Table 2.3.1.2.8.2.1.1-1 Status Codes Received by DICOM SERVER AE for Basic Film Session SOP Class N-CREATE

| Service Status | Status Codes | Further Meaning | Application Behavior When receiving Status Codes |
|----------------|--------------|-------------------------|--|
| Failure | 0119 | Class-instance conflict | Pauses print job and displays print failure message on film composer UI. Error details along with the status code is logged. |
| | 0210 | Duplicate invocation | Pauses print job and displays print failure message on film composer UI. Error details along with the status code is logged. |

| | | | |
|---------|------|-----------------------------------|--|
| | 0111 | Duplicate SOP Instance | Pauses print job and displays print failure message on film composer UI. Error details along with the status code is logged. |
| | 0106 | Invalid attribute value | Pauses print job and displays print failure message on film composer UI. Error details along with the status code is logged. |
| | 0117 | Invalid SOP instance | Pauses print job and displays print failure message on film composer UI. Error details along with the status code is logged. |
| | 0120 | Missing attribute | Pauses print job and displays print failure message on film composer UI. Error details along with the status code is logged. |
| | 0121 | Missing attribute value | Pauses print job and displays print failure message on film composer UI. Error details along with the status code is logged. |
| | 0212 | Mistyped argument | Pauses print job and displays print failure message on film composer UI. Error details along with the status code is logged. |
| | 0105 | No such attributes | Pauses print job and displays print failure message on film composer UI. Error details along with the status code is logged. |
| | 0118 | No such SOP Class | Pauses print job and displays print failure message on film composer UI. Error details along with the status code is logged. |
| | 0112 | No such SOP Instance | Pauses print job and displays print failure message on film composer UI. Error details along with the status code is logged. |
| | 0110 | Processing failure | Pauses print job and displays print failure message on film composer UI. Error details along with the status code is logged. |
| | 0213 | Resource limitation | Pauses print job and displays print failure message on film composer UI. Resource limitation error details is logged. |
| | 0211 | Unrecognized operation | Pauses print job and displays print failure message on film composer UI. Error details along with the status code is logged. |
| Warning | B600 | Memory allocation not supported | Pauses print job and displays print failure message on film composer UI. Error details along with the status code is logged. |
| Success | 0000 | Film session successfully created | Logs film session instance UID and proceeds for creating film box. |
| * | * | Any other status code. | Pauses print job and displays print failure message on film composer UI. Error details along with the status code is logged. |

If a Failure/Warning status is returned by the Print SCP during the N-CREATE operation of the Film Session, the association will be terminated.

2.3.1.2.8.2.1.2 Basic Film Box SOP Class

The DICOM SERVER AE supports the following DIMSE Service Elements for the Basic Film Box SOP Class:

- N-CREATE - Requests the Print SCP to create an instance of Film Box.
- N-ACTION - Requests the Print SCP to print the Film Box onto Printer.
- N-DELETE - Requests the Print SCP to delete the Film Box Instance.

Only one association is opened at a time. The association is open until the response message is returned from the SCP or a network error occurs. No other configurable timers are available.

Following are the status codes that are more specifically processed when receiving messages from a **Print** SCP equipment for the Basic Film Box SOP Class N-CREATE:

Table 2.3.1.2.8.2.1.2-1 Status Codes Received by DICOM SERVER AE for Basic Film Box SOP Class N-CREATE

| Service Status | Status Codes | Further Meaning | Application Behavior When receiving Status Codes |
|----------------|--------------|--|--|
| Failure | C616 | There is an existing Film Box that has not been printed and N-ACTION at the Film Session level is not supported. A new Film Box will not be created when a previous Film Box has not been printed. | Pauses print job and displays print failure message on film composer UI. Error details along with the status code is logged. |
| | 0119 | Class-instance conflict | Pauses print job and displays print failure message on film composer UI. Error details along with the status code is logged. |
| | 0210 | Duplicate invocation | Pauses print job and displays print failure message on film composer UI. Error details along with the status code is logged. |
| | 0111 | Duplicate SOP Instance | Pauses print job and displays print failure message on film composer UI. Error details along with the status code is logged. |
| | 0106 | Invalid attribute value | Pauses print job and displays print failure message on film composer UI. Error details along with the status code is logged. |
| | 0117 | Invalid SOP instance | Pauses print job and displays print failure message on film composer UI. Error details along with the status code is logged. |
| | 0120 | Missing attribute | Pauses print job and displays print failure message on film composer UI. Error details along with the status code is logged. |
| | 0121 | Missing attribute value | Pauses print job and displays print failure message on film composer UI. Error details along with the status code is logged. |

| | | | |
|---------|------|--|--|
| Warning | 0212 | Mistyped argument | Pauses print job and displays print failure message on film composer UI. Error details along with the status code is logged. |
| | 0105 | No such attributes | Pauses print job and displays print failure message on film composer UI. Error details along with the status code is logged. |
| | 0118 | No such SOP Class | Pauses print job and displays print failure message on film composer UI. Error details along with the status code is logged. |
| | 0112 | No such SOP Instance | Pauses print job and displays print failure message on film composer UI. Error details along with the status code is logged. |
| | 0110 | Processing failure | Pauses print job and displays print failure message on film composer UI. Error details along with the status code is logged. |
| | 0213 | Resource limitation | Pauses print job and displays print failure message on film composer UI. Resource limitation error details is logged. |
| | 0211 | Unrecognized operation | Pauses print job and displays print failure message on film composer UI. Error details along with the status code is logged. |
| | B605 | Requested Min Density or Max Density outside of printer's operating range. The printer will use its respective minimum or maximum density value instead. | Pauses print job and displays print failure message on film composer UI. Error details along with the status code is logged. |
| Success | 0000 | Film box successfully created | Proceed for setting image box. |
| * | * | Any other status code. | Pauses print job and displays print failure message on the film composer UI. Error details along with the status code is logged. |

If a Failure or Warning status is returned during the N-CREATE operation of the Film Box, the association will be terminated.

Following are the status codes that are more specifically processed when receiving messages from a **Print SCP** equipment for the Basic Film Box SOP Class N-ACTION:

Table 2.3.1.2.8.2.1.2-2 Status Codes Received by DICOM SERVER AE for Basic Film Box SOP Class N-ACTION

| Service Status | Status Codes | Further Meaning | Application Behavior When receiving Status Codes |
|----------------|--------------|---|--|
| Failure | C602 | Unable to create Print Job SOP Instance; print queue is full | Logs "unable to create print job" error. Pauses print job and displays print failure message on the film composer UI. |
| | C603 | Image size is larger than image box size (by using the specified magnification value) | Pauses print job and displays print failure message on the film composer UI. Error details along with the status code is logged. |

| | | |
|------|--|--|
| C604 | Image position collision : multiple images assigned to single image position | Pauses print job and displays print failure message on the film composer UI. Error details along with the status code is logged. |
| C613 | Combined Print Image size is larger than the Image Box size | Pauses print job and displays print failure message on the film composer UI. Error details along with the status code is logged. |
| 0119 | Class-instance conflict | Pauses print job and displays print failure message on the film composer UI. Error details along with the status code is logged. |
| 0210 | Duplicate invocation | Pauses print job and displays print failure message on the film composer UI. Error details along with the status code is logged. |
| 0115 | Invalid argument value | Pauses print job and displays print failure message on the film composer UI. Error details along with the status code is logged. |
| 0117 | Invalid SOP Instance | Pauses print job and displays print failure message on the film composer UI. Error details along with the status code is logged. |
| 0212 | Mistyped argument | Pauses print job and displays print failure message on the film composer UI. Error details along with the status code is logged. |
| 0123 | No such action | Pauses print job and displays print failure message on the film composer UI. Error details along with the status code is logged. |
| 0114 | No such argument | Pauses print job and displays print failure message on the film composer UI. Error details along with the status code is logged. |
| 0118 | No such SOP Class | Pauses print job and displays print failure message on the film composer UI. Error details along with the status code is logged. |
| 0112 | No such SOP Instance | Pauses print job and displays print failure message on the film composer UI. Error details along with the status code is logged. |
| 0110 | Processing failure | Pauses print job and displays print failure message on the film composer UI. Error details along with the status code is logged. |
| 0213 | Resource limitation | Pauses print job and displays print failure message on the film composer UI. Error details along with the status code is logged. |
| 0211 | Unrecognized operation | Pauses print job and displays print failure message on the film composer UI. Error details along with the status code is logged. |

| | | | |
|---------|------|---|--|
| Warning | B603 | Film Box SOP Instance hierarchy does not contain Image Box SOP Instances (empty page) | Pauses print job and displays print failure message on the film composer UI. Error details along with the status code is logged. |
| | B604 | Image size is larger than image box size, the image has been demagnified. | Pauses print job and displays print failure message on the film composer UI. Error details along with the status code is logged. |
| | B609 | Image size is larger than the Image Box size. The Image has been cropped to fit. | Pauses print job and displays print failure message on the film composer UI. Error details along with the status code is logged. |
| | B60A | Image size or Combined Print Image size is larger than the Image Box size. Image or Combined Print Image has been decimated to fit. | Pauses print job and displays print failure message on the film composer UI. Error details along with the status code is logged. |
| Success | 0000 | Film accepted for printing; if supported, the Print Job SOP Instance is created | Proceed in parsing N-Action response. |
| * | * | Any other status code. | Pauses print job and displays print failure message on the film composer UI. Error details along with the status code is logged. |

If a Failure or Warning status is returned during the N-ACTION operation of the Film Box, the association will be terminated.

Following are the status codes that are more specifically processed when receiving messages from a **Print SCP** equipment for the Basic Film Box SOP Class N-DELETE:

Table 2.3.1.2.8.2.1.2-3 Status Codes Received by DICOM SERVER AE for Basic Film Box SOP Class N-DELETE

| Service Status | Status Codes | Further Meaning | Application Behavior When receiving Status Codes |
|----------------|--------------|-------------------------|--|
| Failure | 0119 | Class-instance conflict | Pauses print job and displays print failure message on the film composer UI. Error details along with the status code is logged. |
| | 0210 | Duplicate invocation | Pauses print job and displays print failure message on the film composer UI. Error details along with the status code is logged. |
| | 0117 | Invalid SOP instance | Pauses print job and displays print failure message on the film composer UI. Error details along with the status code is logged. |
| | 0212 | Mistyped argument | Pauses print job and displays print failure message on the film composer UI. Error details along with the status code is logged. |
| | 0118 | No such SOP Class | Pauses print job and displays print failure message on the film composer UI. Error details along with the status code is logged. |
| | 0112 | No such SOP Instance | Pauses print job and displays print failure message on the film composer UI. Error details along with the status code is logged. |

| | | | |
|---------|------|-------------------------------|--|
| | 0110 | Processing failure | Pauses print job and displays print failure message on the film composer UI. Error details along with the status code is logged. |
| | 0213 | Resource limitation | Pauses print job and displays print failure message on the film composer UI. Error details along with the status code is logged. |
| | 0211 | Unrecognized operation | Pauses print job and displays print failure message on the film composer UI. Error details along with the status code is logged. |
| Success | 0000 | Film box successfully deleted | Logs the success message. |
| * | * | Any other status code. | Pauses print job and displays print failure message on the film composer UI. Error details along with the status code is logged. |

If a Failure or Warning status is returned during the N-DELETE operation of the Film Box, the association will be terminated.

2.3.1.2.8.2.1.3 Basic Grayscale and Color Image Box SOP Classes

The DICOM SERVER AE supports the following DIMSE Service Elements for Basic Grayscale and Color Image Box SOP Classes :

- N-SET - Requests the Printer to set the image box attributes.

Only one association is opened at a time. The association is open until the response message is returned from the SCP or a network error occurs. No other configurable timers are available.

Following are the status codes that are more specifically processed when receiving messages from a **Print** SCP equipment for the Basic Grayscale and Color Image Box SOP Classes N-SET:

Table 2.3.1.2.8.2.1.3-1 Status Codes Received by DICOM SERVER AE for Basic Grayscale and Color Image Box SOP Classes N-SET

| Service Status | Status Codes | Further Meaning | Application Behavior When receiving Status Codes |
|----------------|--------------|---|--|
| Failure | C603 | Image size is larger than image box size | Pauses print job and displays print failure message on the film composer UI. Error details along with the status code is logged. |
| | C605 | Insufficient memory in printer to store the image | Log printer memory full error. Pauses print job and displays print failure message on the film composer UI. |
| | C613 | Combined Print Image size is larger than the Image Box size | Pauses print job and displays print failure message on the film composer UI. Error details along with the status code is logged. |

| | | | |
|---------|------|--|--|
| | 0119 | Class-instance conflict | Pauses print job and displays print failure message on the film composer UI. Error details along with the status code is logged. |
| | 0210 | Duplicate invocation | Pauses print job and displays print failure message on the film composer UI. Error details along with the status code is logged. |
| | 0106 | Invalid attribute value | Pauses print job and displays print failure message on the film composer UI. Error details along with the status code is logged. |
| | 0212 | Mistyped argument | Pauses print job and displays print failure message on the film composer UI. Error details along with the status code is logged. |
| | 0117 | Invalid SOP instance | Pauses print job and displays print failure message on the film composer UI. Error details along with the status code is logged. |
| | 0121 | Missing attribute value | Pauses print job and displays print failure message on the film composer UI. Error details along with the status code is logged. |
| | 0105 | No such attributes | Pauses print job and displays print failure message on the film composer UI. Error details along with the status code is logged. |
| | 0118 | No such SOP Class | Pauses print job and displays print failure message on the film composer UI. Error details along with the status code is logged. |
| | 0112 | No such SOP Instance | Pauses print job and displays print failure message on the film composer UI. Error details along with the status code is logged. |
| | 0110 | Processing failure | Pauses print job and displays print failure message on the film composer UI. Error details along with the status code is logged. |
| | 0213 | Resource limitation | Pauses print job and displays print failure message on the film composer UI. Error details along with the status code is logged. |
| | 0211 | Unrecognized operation | Pauses print job and displays print failure message on the film composer UI. Error details along with the status code is logged. |
| Warning | B604 | Image size larger than image box size, the image has been demagnified. | Pauses print job and displays print failure message on the film composer UI. Error details along with the status code is logged. |
| | B605 | Requested Min Density or Max Density outside of printer's operating range. The printer will use its respective minimum or maximum density value instead. | Pauses print job and displays print failure message on the film composer UI. Error details along with the status code is logged. |
| | B609 | Image size is larger than the Image Box size. The Image has been cropped to fit. | Pauses print job and displays print failure message on the film composer UI. Error details along with the status code is logged. |

| | | | |
|---------|------|---|--|
| | B60A | Image size or Combined Print Image size is larger than the Image Box size. The Image or Combined Print Image has been decimated to fit. | Pauses print job and displays print failure message on the film composer UI. Error details along with the status code is logged. |
| Success | 0000 | Image successfully stored in Image Box | Continues setting image box if more images are there, else sends N-Action request. |
| * | * | Any other status code. | Pauses print job and displays print failure message on the film composer UI. Error details along with the status code is logged. |

If a Failure/Warning status is returned during the N-SET operation of the Image Box, the association will be terminated.

2.3.1.2.8.2.1.4 Printer SOP Class

The N-GET DIMSE service is supported for the Printer SOP Class. If an N-EVENT-REPORT DIMSE service is received when the association is active, the DICOM SERVER AE handles the relevant states, but the data received is ignored.

Following are the status codes the Application may send back in the **N-Event-Report** response command to the **Printer SOP Class** SCP Equipment that sent the N-Event-Report request:

Table 2.3.1.2.8.2.1.4-1 Status Codes Returned by DICOM SERVER AE for Printer SOP Class N-Event-Report

| Service Status | Status Code | Further Meaning | Status Code Explanation | Related Fields Sent Back to the SCU |
|----------------|-------------|-----------------|--------------------------------------|-------------------------------------|
| Success | 0000 | | N-EVENT-REPORT received successfully | None |

The DICOM SERVER AE issues the N-GET service to retrieve the printer status. The statuses are processed as follows:

- If Printer status (2110,0010) is NORMAL, the film is printed.
- If Printer status (2110,0010) is FAILURE the print job is terminated. The Printer Status Info (2110,0020) attribute is not processed.
- If Printer status (2110,0010) is WARNING one of two things will happen:
 - If the Printer Status Info (2110,0020) is “RECEIVER FULL” or “SUPPLY EMPTY”, or “FILM JAM” the status is displayed to the user and the print job is aborted.
 - For all other Printer Status Info (2110,0020) values, the status is ignored and the print job continues.

Only one association is opened at a time. The association is open until the response message is returned from the SCP or a network error occurs. No other configurable timers are available.

For the attribute list requested by this product and for the behavior of this product on each returned value, refer to Section 4.6 **Printer SOP Class**.

Following are the status codes that are more specifically processed when receiving messages from a **Print SCP** equipment for the Printer SOP Class N-GET:

2.3.1.2.8.2.1.4-2 Status Codes Received by DICOM SERVER AE for Printer SOP Class N-GET

| Service Status | Status Codes | Further Meaning | Application Behavior When receiving Status Codes |
|----------------|--------------|-------------------------|--|
| Failure | 0107 | Attribute list error | Pauses print job and displays print failure message on the film composer UI. Error details along with the status code is logged. |
| | 0119 | Class-instance conflict | Pauses print job and displays print failure message on the film composer UI. Error details along with the status code is logged. |
| | 0210 | Duplicate invocation | Pauses print job and displays print failure message on the film composer UI. Error details along with the status code is logged. |
| | 0117 | Invalid SOP instance | Pauses print job and displays print failure message on the film composer UI. Error details along with the status code is logged. |
| | 0212 | Mistyped argument | Pauses print job and displays print failure message on the film composer UI. Error details along with the status code is logged. |
| | 0118 | No such SOP Class | Pauses print job and displays print failure message on the film composer UI. Error details along with the status code is logged. |
| | 0112 | No such SOP Instance | Pauses print job and displays print failure message on the film composer UI. Error details along with the status code is logged. |
| | 0110 | Processing failure | Pauses print job and displays print failure message on the film composer UI. Error details along with the status code is logged. |
| | 0213 | Resource limitation | Pauses print job and displays print failure message on the film composer UI. Error details along with the status code is logged. |
| | 0211 | Unrecognized operation | Pauses print job and displays print failure message on the film composer UI. Error details along with the status code is logged. |
| Success | 0000 | Success | Proceed with parsing dataset returned from N-Get response and perform appropriate operations. Refer section 4.2.5 |

| | | | |
|---|---|------------------------|--|
| * | * | Any other status code. | Pauses print job and displays print failure message on the film composer UI. Error details along with the status code is logged. |
|---|---|------------------------|--|

Refer **Section.4 Print Management Implementation.**

2.3.1.3 Association Acceptance Policy

The DICOM Server AE places limitations on who may connect to it.

If the Remote AE needs to “Push Images” or “Query/Retrieve Images”, to the local system then it has to be configured in the Local system to do the same.

When the DICOM Server AE accepts an association for image storage, it will receive any images transmitted on that association and store the images on disk.

It will also respond to queries from Remote AEs by sending matching entries. Any Remote AE can request and receive a list of images on the local database. The Remote AE must be configured in the local database manager’s list of Remote AE for it to be able to retrieve images from DICOM Server AE.

Any remote AE can open an association to the DICOM Server AE for the purpose of verification.

It will also listen for and receive Storage Commitment notification (N-EVENT-REPORT) from a Remote Storage commitment SCP.

2.3.1.3.1 Real-World Activity: Receive Images

This AE is indefinitely listening for associations. No operator action is required to receive an image.

2.3.1.3.1.1 Associated Real-World Activity

The Real-World Activity associated with the Receive Image(s) operation is the storage of the image on the disk drive of the GEHC CT.

2.3.1.3.1.2 Presentation Context Table

Table 2.3.1.3.1.2-1: Accepted Presentation Contexts for DICOM Server AE and Real-World Activity Receive Image(s)

| Presentation Context Table – Accepted | | | | | |
|---------------------------------------|---------------------------|--|-------------------|------|----------------------|
| Abstract Syntax | | Transfer Syntax | | Role | Extended Negotiation |
| Name | UID | Name List | UID List | | |
| CT Image Storage | 1.2.840.10008.5.1.4.1.1.2 | Implicit VR Little Endian Explicit VR Little Endian | 1.2.840.10008.1.2 | SCP | None |

| | | | | | |
|---------------------------------|-------------------------------|--|---|-----|------|
| | | Explicit VR Big Endian | 1.2.840.10008.1.2.1 1.2.840.10008.1.2.2 | | |
| MR Image Storage | 1.2.840.10008.5.1.4.1.1.4 | Implicit VR Little Endian Explicit VR Little Endian Explicit VR Big Endian | 1.2.840.10008.1.2 1.2.840.10008.1.2.1 1.2.840.10008.1.2.2 | SCP | None |
| PET Image Storage | 1.2.840.10008.5.1.4.1.1.128 | Implicit VR Little Endian Explicit VR Little Endian Explicit VR Big Endian | 1.2.840.10008.1.2 1.2.840.10008.1.2.1 1.2.840.10008.1.2.2 | SCP | None |
| RT Structure Set Storage | 1.2.840.10008.5.1.4.1.1.481.3 | Implicit VR Little Endian Explicit VR Little Endian Explicit VR Big Endian | 1.2.840.10008.1.2 1.2.840.10008.1.2.1 1.2.840.10008.1.2.2 | SCP | None |
| Secondary Capture Image Storage | 1.2.840.10008.5.1.4.1.1.7 | Implicit VR Little Endian Explicit VR Little Endian Explicit VR Big Endian | 1.2.840.10008.1.2 1.2.840.10008.1.2.1 1.2.840.10008.1.2.2 | SCP | None |
| Enhanced SR | 1.2.840.10008.5.1.4.1.1.88.22 | Implicit VR Little Endian Explicit VR Little Endian Explicit VR Big Endian | 1.2.840.10008.1.2 1.2.840.10008.1.2.1 1.2.840.10008.1.2.2 | SCP | None |
| X-Ray Radiation Dose SR | 1.2.840.10008.5.1.4.1.1.88.67 | Implicit VR Little Endian Explicit VR Little Endian Explicit VR Big Endian | 1.2.840.10008.1.2 1.2.840.10008.1.2.1 1.2.840.10008.1.2.2 | SCP | None |

Note: The SCP does not have a default acceptance policy if more than one acceptable transfer syntaxes are proposed by the SCU. It is the responsibility of the SCU to make a selection from more than one transfer syntaxes accepted. If multiple transfer syntaxes are proposed in the same presentation context, the SCP will accept the first one

2.3.1.3.1.2.1 SOP Specific Conformance to C_STORE SCP

The DICOM Server AE conforms to the SOP’s of the Storage Service Class at Level 2 (FULL), and stores all standard and private data elements of received SOP Instances. It does not coerce any data elements during Storage. The DICOM SERVER AE provides Level 1 Digital Signature support.

Each C-STORE SCP operation supports an “Association Timer” and “Operation Inactivity Timer” with time out values of 30 seconds, 15 seconds respectively and is configurable.

- Association Timer – duration for SCP to respond to an association request.
- Operation Inactivity Timer – duration between two commands after the association.

Successfully received SOP Instances may be accessed via the user interface and by DICOM network query retrieve. SOP Instances are stored until manually deleted by the user

Image Reception

If the DICOM Server AE returns one of the following status codes, then the C-STORE operation was unsuccessful and no image will be installed. A message will appear in the system log informing the user of the failure.

| Service Status | Status Code | Further Meaning | Status Code Explanation | Related Fields Sent Back to the SCU |
|----------------|-------------|--|---|-------------------------------------|
| Failure | A700 | Refused: Out of resources | Not enough disk space to store DICOM image. | (0000,0902) |
| | A710 | Refused: Out of Resources | Remote AE is not given permission to store on this AE | (0000,0902) |
| | A711 | Refused: Out of resources | Unable to connect to local database for storage. (such as maximum connection limit reached) | (0000,0902) |
| | A900 | Error: Data Set does not match SOP Class | Storage of the DICOM object in local database failed due to corrupt/invalid data set. | (0000,0902) |
| | C000 | Error: Cannot understand | Storage of the DICOM object in local database failed. | (0000,0902) |

In the event of a successful C-STORE operation (Status Code 0000), the image has successfully been written to disk. The image will then be accessed in the same manner as any other image by the applications on the GEHC CT system.

Images may be deleted when instructed to do so by the user. Thus the duration of the storage of the image is determined by the users of the GEHC CT system.

Image Installation

If the image installation is unsuccessful, a message will appear in the Message Log informing the user of the failure and the image will be removed.

If the image installation process finds that an element is not encoded according to the DICOM standard, it will fail to install the image and the file will be removed.

Image Installation of non-GE Created MR or CT Images

Images received from non-GE products are installed as the appropriate image object. Their private data elements will be maintained if the negotiated transfer syntax is Explicit Little or Big Endian. Also if any critical fields (mandatory) are missing, then the image will not be installed.

This AE is indefinitely listening for associations. No operator action is required to respond to a *verification* message.

2.3.1.3.1.3 Presentation Context Acceptance Criterion

The DICOM SERVER AE evaluates each Presentation Context independently, and accepts any Presentation Context that matches an Abstract Syntax for any Real-World Activity.

2.3.1.3.1.4 Transfer Syntax Selection Policies

Within each Presentation Context, the DICOM SERVER AE will select Transfer Syntaxes according to the following priority (highest priority first):

1. Explicit VR Little Endian
2. Implicit VR Little Endian
3. Explicit VR Big Endian

2.3.1.3.2 Real-World Activity: Verification Request from Remote AE

2.3.1.3.2.1 Associated Real-World Activity

This AE is indefinitely listening for associations. No operator action is required to respond to a verification message. The Real-World Activity associated with the verification request is to send a C-ECHO response message with a status of “success” to the requesting AE.

2.3.1.3.2.2 Presentation Context Table

Table 2.3.1.3.2.2-1: Acceptable Presentation Contexts for DICOM Server AE and Real-World Activity Verification Request

| Presentation Context Table | | | |
|----------------------------|-----------------|------|----------------------|
| Abstract Syntax | Transfer Syntax | Role | Extended Negotiation |

| Name | UID | Name List | UID List | | |
|--------------|-------------------|--|---|-----|------|
| Verification | 1.2.840.10008.1.1 | Implicit VR Little Endian Explicit VR Little Endian Explicit VR Big Endian | 1.2.840.10008.1.2 1.2.840.10008.1.2.1 1.2.840.10008.1.2.2 | SCP | None |

2.3.1.3.2.2.1 SOP Specific Conformance to C_ECHO SCP

The DICOM Server AE provides standard conformance to the DICOM Verification Service Class.

Each ECHO operation supports an “Association Timer” and “Operation Inactivity Timer” with time out values of 30 seconds and 15 seconds respectively.

2.3.1.3.2.3 Presentation Context Acceptance Criterion

The DICOM SERVER AE evaluates each Presentation Context independently, and accepts any Presentation Context that matches an Abstract Syntax for any Real-World Activity.

2.3.1.3.2.4 Transfer Syntax Selection Policies

Within each Presentation Context, the DICOM SERVER AE will select Transfer Syntaxes according to the following priority (highest priority first):

1. Explicit VR Little Endian
2. Implicit VR Little Endian
3. Explicit VR Big Endian

2.3.1.3.3 Real-World Activity: Search Local Database (Query Request from Remote AE)

This AE is indefinitely listening for associations. No operator action is required to respond to a *query* request.

2.3.1.3.3.1 Associated Real-World Activity

The Real-World Activity associated with “*Search Local Database*” is to search the local database for entries that match the request and send a C-FIND response message with a status of “pending” for each matching entry and send a C-FIND response message with a status of "success" after the last "pending" response.

If the C-FIND SCP receives a C-FIND-CANCEL request, it sends a C-FIND response message with a status of "cancel (FE00H)".

2.3.1.3.3.2 Presentation Context Table

Table 2.3.1.3.3.2-1: Acceptable Presentation Contexts for DICOM Server AE and Real-World Activity Query Request

| Presentation Context Table | | | | | |
|--------------------------------|-----------------------------|--|---|------|----------------------|
| Abstract Syntax | | Transfer Syntax | | Role | Extended Negotiation |
| Name | UID | Name List | UID List | | |
| Study Root Query/Retrieve FIND | 1.2.840.10008.5.1.4.1.2.2.1 | Implicit VR Little Endian Explicit VR Little Endian Explicit VR Big Endian | 1.2.840.10008.1.2 1.2.840.10008.1.2.1 1.2.840.10008.1.2.2 | SCP | None |

2.3.1.3.3.2.1 SOP Specific Conformance to C-FIND SCP

Each C-FIND SCP operation supports an “Association Timer” and “Operation Inactivity Timer” with time out values of 30 seconds and 15 seconds respectively.

All Required (R) and Unique (U) study, series, and image level keys for the Study-Root Query/Retrieve information model are supported. Some optional (O) keys are also supported as described in the following tables.

Table 2.3.1.3.3.2.1-1 Supported study level keys

| Description | Type | Tag | Usage |
|--------------------|------|-----------|----------|
| Study date | R | 0008,0020 | Matched |
| Study time | R | 0008,0030 | Matched |
| Accession number | R | 0008,0050 | Matched |
| Patient’s name | R | 0010,0010 | Matched |
| Patient id | R | 0010,0020 | Matched |
| Study id | R | 0020,0010 | Matched |
| Study Instance UID | U | 0020,000D | Matched |
| Study description | O | 0008,1030 | Returned |
| Suite Id | P | 0009,0002 | Returned |

Table 2.3.1.3.3.2.1-2 Supported series level keys

| Description | Type | Tag | Usage |
|---------------------|------|-----------|----------|
| Modality | R | 0008,0060 | Matched |
| Series number | R | 0020,0011 | Matched |
| Series Instance UID | U | 0020,000E | Matched |
| Series description | O | 0008,103E | Returned |
| Manufacturer | O | 0008,0070 | Returned |

| Description | Type | Tag | Usage |
|------------------|------|-----------|----------|
| Images in series | O | 0020,1002 | Returned |

Table 2.3.1.3.3.2.1-3 Supported image level keys

| Description | Type | Tag | Usage |
|-------------------------------------|------|-----------|----------|
| Image number | R | 0020,0013 | Matched |
| Image Instance UID | U | 0008,0018 | Matched |
| Image type | O | 0008,0008 | Returned |
| Rows | O | 0028,0010 | Returned |
| Columns | O | 0028,0011 | Returned |
| Image position | O | 0020,0032 | Returned |
| Image orientation | O | 0020,0037 | Returned |
| Slice thickness | O | 0018,0050 | Returned |
| Slice spacing | O | 0018,0088 | Returned |
| Gantry tilt | O | 0018,1120 | Returned |
| Convolution kernel | O | 0018,1210 | Returned |
| Reconstruction diameter | O | 0018,1100 | Returned |
| Data collection diameter | O | 0018,0090 | Returned |
| Flip angle | O | 0018,1314 | Returned |
| Echo number | O | 0018,0086 | Returned |
| Echo time | O | 0018,0081 | Returned |
| Inversion time | O | 0018,0082 | Returned |
| Repetition time | O | 0018,0080 | Returned |
| Trigger time | O | 0018,1060 | Returned |
| Dfov Rect | P | 0019,001E | Returned |
| Midscan Time | P | 0019,0024 | Returned |
| Azimuth | P | 0019,0026 | Returned |
| Number of Echo | P | 0019,007E | Returned |
| Scout Anref | P | 0021,004A | Returned |
| Location RAS | P | 0027,0040 | Returned |
| Location | P | 0027,0041 | Returned |
| Center R Coordinate | P | 0027,0042 | Returned |
| Center A Coordinate | P | 0027,0043 | Returned |
| Table Start Location | P | 0027,0050 | Returned |
| Table End Location | P | 0027,0051 | Returned |
| RAS Letter for Side of Image | P | 0027,0052 | Returned |
| RAS Letter for Anterior/Posterior | P | 0027,0053 | Returned |
| RAS Letter for Scout Start Location | P | 0027,0054 | Returned |
| RAS Letter for Scout End Location | P | 0027,0055 | Returned |
| Image Dimension X | P | 0027,0060 | Returned |
| Image Dimension Y | P | 0027,0061 | Returned |

Note: In the above tables the type field has the following meaning:

R = Required **U** = Unique **O** = Optional **P** = Private

Only keys with Usage type *Matched* will be matched against values in the database.

Values in keys of type *Returned* will be ignored and will be filled in with data from the database.

If an optional key is requested that does not appear in any of the tables above, that key will be ignored and no corresponding element will be returned.

If the database does not have a value corresponding to any requested optional key a zero-length element will be returned.

Sequence matching is not supported.

Range matching is supported for attributes of type date and time.

Only hierarchical query is supported.

Special character *?* can be used to match any single character and special character *** can be used to match any character or set of characters for (0008, 0050) Accession Number, (0010, 0010) Patient's Name, (0010, 0020) Patient ID and (0020, 0010) Study ID.

Except sequence matching all other matching are supported. (i.e. wildcard ("***", "*?*") and range ("*-*") matching is supported as defined in DICOM PS3.4 Section C.2 *Query/Retrieve Information Model Definition*.)

Following are the status codes the Application may send back to the SCU Equipment while performing the requested **Query**:

| Service Status | Status Code | Further Meaning | Status Code Explanation | Related Fields Sent Back to the SCU |
|----------------|-------------|--------------------------|--|-------------------------------------|
| Failure | A900 | Error: Invalid dataset | This status code is sent for the following reasons 1. When does not have required information, like query retrieve level | (0000,0902) |
| | C001 | Error: Unable to process | This status code is sent for the following reasons 1. When remote AE is not given permission to store on this AE. 2. Not able to connect to local database, because of max connection limit reached. 3. Database query fails. | (0000,0902) |

| | | | | |
|---------|------|--|--|------------|
| Cancel | FE00 | Matching terminated due to cancel | This status code will be returned when DICOM SERVER AE receives C-FIND-CANCEL from remote AE | None |
| Success | 0000 | Matching is complete - No final identifier is supplied | Matching complete | None |
| Pending | FF00 | Matches are continuing - Current Match is supplied and any Optional Keys were supported in the same manner as Required Keys. | For pending messages | Identifier |

2.3.1.3.3.3 Presentation Context Acceptance Criterion

The DICOM SERVER AE evaluates each Presentation Context independently, and accepts any Presentation Context that matches an Abstract Syntax for any Real-World Activity.

2.3.1.3.3.4 Transfer Syntax Selection Policies

Within each Presentation Context, the DICOM SERVER AE will select Transfer Syntaxes according to the following priority (highest priority first):

1. Explicit VR Little Endian
2. Implicit VR Little Endian
3. Explicit VR Big Endian

2.3.1.3.4 Real-World Activity: Move Images (Retrieve Request from Remote AE)

This AE is indefinitely listening for associations. No operator action is required to respond to a *retrieve* request.

2.3.1.3.4.1 Associated Real-World Activity

The Real-World Activity associated with “*Move Images*” is to send all images corresponding to the C-MOVE request to the destination AE through a separate association.

If the C-MOVE SCP receives a C-MOVE-CANCEL request, it discontinues the move operation and closes the separate association.

2.3.1.3.4.2 Presentation Context Table

Table 2.3.1.3.4.2-1: Acceptable Presentation Contexts for DICOM Server AE and Real-World Activity “Move Images”

| Presentation Context Table | | | | | |
|--------------------------------|-----------------------------|--|---|------|----------------------|
| Abstract Syntax | | Transfer Syntax | | Role | Extended Negotiation |
| Name | UID | Name List | UID List | | |
| Study Root Query/Retrieve MOVE | 1.2.840.10008.5.1.4.1.2.2.2 | Implicit VR Little Endian Explicit VR Little Endian Explicit VR Big Endian | 1.2.840.10008.1.2 1.2.840.10008.1.2.1 1.2.840.10008.1.2.2 | SCP | None |

2.3.1.3.4.2.1 SOP Specific Conformance to C-MOVE SCP

The DICOM Server AE provides standard conformance to the baseline Study-root C-MOVE Service Class SCP.

Each C-MOVE SCP operation supports an “Association Timer” and “Operation Inactivity Timer” with time out values of 30 seconds and 15 seconds and 60 minutes respectively. All images requested in a C-MOVE-RQ will be sent over a single association.

A C-MOVE-RSP with a “pending” status will be returned to the requester every five images.

C-MOVE supports list of Studies (through list of Study UIDs), list of Series (through list of Series UIDs) and list of Images (through list of Instances UIDs).

To send C-MOVE to a 3rd party system is supported if 3rd party destination AE details are configured in the system.

The C-MOVE SCP will invoke C-STORE requests for the following SOP classes:

| SOP Class Name | SOP Class UID |
|---|-------------------------------|
| CT Image Information Storage | 1.2.840.10008.5.1.4.1.1.2 |
| MR Image Information Storage | 1.2.840.10008.5.1.4.1.1.4 |
| PET Image Information Storage | 1.2.840.10008.5.1.4.1.1.128 |
| RT Structure Set Storage | 1.2.840.10008.5.1.4.1.1.481.3 |
| Secondary Capture image storage | 1.2.840.10008.5.1.4.1.1.7 |
| Grayscale Softcopy Presentation State Storage | 1.2.840.10008.5.1.4.1.1.11.1 |
| Enhanced SR | 1.2.840.10008.5.1.4.1.1.88.22 |
| X-Ray Radiation Dose SR | 1.2.840.10008.5.1.4.1.1.88.67 |

Following are the status codes the Application may send back to the SCU Equipment while performing the requested Retrieve:

| Service Status | Status Code | Further Meaning | Status Code Explanation | Related Fields Sent Back to the SCU |
|----------------|-------------|---|---|---|
| Failure | A701 | Refused: Out of resources - Unable to calculate number of matches | This status code is sent when local database query fails | (0000,0902) |
| | A702 | Refused: Out of resources - Unable to perform sub-operations | This status code is sent to Retrieve SCU when the association is rejected by the C-STORE SCP | (0000,0902) |
| | A801 | Error: Move Destination Unknown | This status code is sent when the destination AE named in the C-MOVE request is unknown to DICOM SERVER AE. | (0000,0902) |
| | A900 | Error: Invalid dataset | This status code is sent for the following reasons 1.When the retrieve request does not contain required information, like query retrieve level | (0000,0902) |
| | C001 | Error: Unable to process | This status code is sent for the following reasons 1.When Remote AE does not have permissions to use DICOM SERVER AEs retrieve service 2. Not able to connect to local database, because of max connection limit reached. 3. Database query fails. | (0000,0902) |
| Cancel | FE00 | Sub-operations terminated due to a Cancel indication | This status code is sent when DICOM SERVER AE receives C-MOVE-CANCEL request from the Remote AE. | (0000,1021) (0000,1022) (0000,1023) (0000,0902)) |
| Success | 0000 | Sub-operations Complete - No Failure. | All the composite SOP instances have been successfully sent to the C-MOVE destination | (0000,1021) (0000,1022) (0000,1023) |

| | | | | |
|---------|------|---------------------------------|--|--|
| Pending | FF00 | Sub-operations are continuing - | For pending sub operation to remote AE | (0000,1020) (0000,1021) (0000,1022) (0000,1023) |
|---------|------|---------------------------------|--|--|

2.3.1.3.4.3 Presentation Context Acceptance Criteria

The DICOM SERVER AE evaluates each Presentation Context independently, and accepts any Presentation Context that matches an Abstract Syntax for any Real-World Activity.

2.3.1.3.4.4 Transfer Syntax Selection Policy

Within each Presentation Context, the DICOM SERVER AE will select Transfer Syntaxes according to the following priority (highest priority first):

1. Explicit VR Little Endian
2. Implicit VR Little Endian
3. Explicit VR Big Endian

2.3.1.3.5 Real-World Activity: Listen to remote Storage Commitment SCP

The DICOM SERVER AE is indefinitely listening for associations. No operator action is required to receive a Storage Commitment notification (N-EVENT-REPORT).

2.3.1.3.5.1 Associated Real-World Activity

The Real-World Activity associated consists into:

- Flag the exams/series that have been committed (transfer of ownership) in the database
- Display the error when some images of a patient existing in the database have not been committed

2.3.1.3.5.2 Presentation Context Table

| Presentation Context Table – Accepted by DICOM SERVER AE for Activity <i>Storage commit notification from Remote AE</i> | | | | | |
|--|----------------------|--|---|-------------|-----------------------------|
| Abstract Syntax | | Transfer Syntax | | Role | Extended Negotiation |
| Name | UID | Name List | UID List | | |
| Storage Commitment Push Model | 1.2.840.10008.1.20.1 | Implicit VR Little Endian Explicit VR Little Endian Explicit VR Big Endian | 1.2.840.10008.1.2 1.2.840.10008.1.2.1 1.2.840.10008.1.2.2 | SCU | None |

2.3.1.3.5.2.1 SOP Specific DICOM Conformance Statement for the Storage Commitment Push Model SOP Class (N-EVENT-REPORT)

The DICOM SERVER AE monitors an “Operation Inactivity” timer. The connection with the SCU will be terminated if it is inactive for the configured time-out interval. Default time-out is 15 seconds and is configurable.

Once the N_EVENT_REPORT response is received from the SCP, the following actions will be taken depending on the status of response.

2.3.1.3.5.2.1.1 Commitment response with SUCCESS status

The “Archived” flag information in the browser for all the successfully archived exam/series will be updated. The archive status column in the browser will be changed to display “Archived” icon to indicate that the exam/series has been archived successfully. The job queue entry will be removed. N_EVENT_REPORT response will be sent on the same association as N_EVENT_REPORT request. No data set will be sent along with the response.

Following are the status codes the Application may send back to the SCP Equipment after receiving the N-EVENT-REPORT:

| Service Status | Status Codes | Further Meaning | Status Code sending explanation | Related Fields sent back to the SCU |
|----------------|--------------|--------------------|---|-------------------------------------|
| Error | 0110 | Processing Failure | Indicates that an internal error occurred while processing. | None |
| Success | 0000 | Success | The storage commitment result received successfully. | None |

2.3.1.3.5.2.1.2 Commitment response with FAILURE status

In the event of complete/partial failure the user will be notified about the status and the job entry will be paused. There is no attempt made to automatically retry the failed SOP instances. However the user can manually retry the failed jobs. Such requests will be treated as new requests. This will go through the complete sequence of operations once again.

The failure reason is ignored. Failed SOP instances will have their “Archived” flag information unaltered. Failed SOP instances are logged.

Note: The archived status flag in the browser is a shared flag with local archive. When the status is “Archived”, it means that the images are archived but doesn’t specify whether on local archive device or remote archive device. It is left to the user’s discretion whether the local SOP instances are to be deleted.

N_EVENT_REPORT response will be sent on the same association as N_EVENT_REPORT request. No data set will be sent along with the response.

Please see [section 5.1.2.1](#) for the complete list of N_EVENT_REPORT failure statuses processed by the system.

Following are the status codes the Application may send back to the SCP Equipment after receiving the N-EVENT-REPORT:

| Service Status | Status Codes | Further Meaning | Status Code sending explanation | Related Fields sent back to the SCU |
|-----------------------|---------------------|------------------------|---|--|
| Error | 0110 | Processing Failure | Indicates that an internal error occurred while processing. | None |
| Success | 0000 | Success | The storage commitment result received successfully. | None |

2.3.1.3.5.3 Presentation Context Acceptance Criterion

The DICOM SERVER AE evaluates each Presentation Context independently, and accepts any Presentation Context that matches an Abstract Syntax for any Real-World Activity.

2.3.1.3.5.4 Transfer Syntax Selection Policies

Within each Presentation Context, the DICOM SERVER AE will select Transfer Syntaxes according to the following priority (highest priority first):

1. Explicit VR Little Endian
2. Implicit VR Little Endian
3. Explicit VR Big Endian

2.4 Communication Profiles

2.4.1 Supported Communication Stacks (parts 8)

DICOM Upper Layer (Part 8) is supported using TCP/IP.

2.4.2 TCP/IP Stack

The TCP/IP stack is inherited from a UNIX Operating System.

2.4.2.1 Physical Media Support

Ethernet v2.0, IEEE 802.3

2.4.3 Others

- DHCP is not supported.
- IPv6 is not supported.

2.5 Extensions / Specializations / Privatizations

2.5.1 Standard Extended Elements

Refer to Appendix A: *CT Image and Secondary Capture* for supported Standard Extended Elements.

2.5.2 Private Data Elements

Refer to Appendix B: *Private Data Elements* for a complete listing of private data elements used with this implementation

2.6 Configuration

2.6.1 AE Title/Presentation Address Mapping

The GEHC CT system allows the user to “add”, “Remove”, or “Update the mapping of remote AE Titles to IP Addresses and Ports. These options can be selected from “Network Configuration” dialog box displayed by choosing “Network Configuration” from the “Tools” pull-down menu from the local database browser.

2.6.2 Configurable Parameters

The following fields are configurable for this AE (local):

- Local AE Title
- Local IP Address
- Local Listening Port Number
- Local IP Netmask

Note: The local port on which the GEHC CT system receives DICOM incoming TCP connections is port **4006**.

The following fields are configurable for every Remote DICOM AE:

- Remote AE Title
- Remote IP Address
- Listening TCP/IP Port Number
- Max PDU length

The following fields are configurable:

- Association Establishment Timer time-out
- Store, Find, Move Timers time-out
- Inactivity, Echo Timers time-out
- Maximum PDU length

Note: Timeouts are set in network-cfg.xml and mergecom.pro files

Note: All configurations should be performed by a GE Field Service Engineer.

2.6.2.1 Print Configuration

The following fields are configurable for DICOM Print. The valid ranges are as described in Section 6.2

| Attribute Name | DICOM Tag |
|---------------------------|--------------|
| Medium Type | (2000, 0030) |
| Film Destination | (2000, 0040) |
| Magnification Type | (2010, 0060) |
| Min Density | (2010, 0120) |
| Max Density | (2010, 0130) |
| Empty Image Density | (2010, 0110) |
| Border Density | (2010, 0100) |
| Configuration Information | (2010, 0150) |
| Smoothing Type | (2010, 0080) |

The following network timers are supported and are configurable. When these timers expire the association is terminated. The default values are defined in dprint.cfg as below

| Timeout Description | Default Value | Configuration Parameter Name |
|----------------------|---------------|------------------------------|
| Association Time out | 120 seconds | bi_assoc_tio |
| Session Time out | 1200 seconds | bi_session_tio |
| Echo Time out | 200 seconds | bi_echo_tio |
| N-SET Time out | 300 seconds | bi_nset_tio |
| N-ACTION Time out | 300 seconds | bi_naction_tio |
| N-CREATE Time out | 300 seconds | bi_ncreate_tio |
| N-DELETE Time out | 300 seconds | bi_ndelete_tio |
| N-GET Time out | 100 seconds | bi_nget_tio |

2.6.2.2 PPS Configuration

The parameters Remote MPPS AE IP Address, Remote AE(HIS/RIS) IP Port and Remote MPPS AE Title define where the MPPS requests will be directed.

The default value of Local AE Title is host name of the scanner appended with string “_PPS”. If the length exceeds 16 characters the AE Title is truncated to a length of 16.)

Configurable DICOM Data:

The following DICOM sequences are currently defaulted to be automatically sent in the PPS N-CREATE and PPS N-SET however PPS can be configured to not send them:

- (0008, 1032) Procedure Code Sequence – sent in the PPS N-CREATE. If not sent, the PPS N-CREATE will contain an empty Procedure Code Sequence.
- (0040, 0260) Performed Protocol Code Sequence – sent in the PPS N_SET. If not sent, the PPS N-SET will not contain a Performed Protocol Code Sequence.

The configuration is performed by GEHC Field Service Engineers changing parameters in configuration file *Dicom.cfg*

2.6.2.3 Modality Worklist Query Configuration

HIS/RIS is configured as a remote AE. These parameters define where worklist queries will be directed. Configuration of these parameters is performed by GEHC Field Service engineers using the ModalityWorklist installation facilities.

The following parameters are configurable for the DICOM Worklist Server AE:

- Local (Worklist Server) AE Title (automatically set to host name of scanner)
- Local IP address
- Local IP netmask
- Local IP gateway

The following parameters are configurable by changing their values in the configuration file ***/usr/g/config/WLdcm.cfg***. Note that these parameters typically need not be changed. Furthermore, no support is provided for retaining changed settings: the values will require changing again after a system software upgrade.

- Implementation UID
- PDU size
- Association time-out period
- Session time-out period
- C-FIND time-out period

2.6.2.4 GSPS Configuration

The Exam Split feature is an option with two modes described in Section 8.2.

Exam Split allows for the configuration of the following parameters that pertain to the remote AE.

- Remote GSPS AE IP Address IP Address used to contact the remote GSPS AE
- Remote GSPS IP Port: IP Port used to contact the remote GSPS AE
- Remote GSPS AE Title Application Entity Title used to contact the remote GSPS AE

- Remote HES AE IP Address IP Address used to contact the remote HES AE
- Remote HES IP Port: IP Port used to contact the remote HES AE
- Remote HES AE Title Application Entity Title used to contact the remote HES AE

The following are configurable for the GSPS.

- Remote Host IP address
- Remote Host port
- Remote AE Title
- Changesplit_mode <HES/VES>

2.7 Support of Extended Character Sets

In addition to the DICOM default character set, GEHC CT supports the ISO IR 100 Latin alphabet #1 supplementary set for the purpose of interchange.

As a Storage SCP, the product will accept SOP Instances with any value of Specific Character Set (0008,0005).

As a Query SCU, it will similarly accept response items with any value of Specific Character Set. However, it will display in the user interface only characters specified as within ISO_IR 6 (ASCII) or the configured extended character set.

The product user interface will allow the user to enter characters from the console keyboard that is within ASCII or the configured extended character set. If any such extended characters are included in SOP Instances or in query identifier matching fields, the product will appropriately specify the extended character set in Specific Character Set (0008,0005).

The generated MPPS messages will also specify the character set in (0008,0005) if the referenced images contain extended characters.

As a Modality Worklist SCU, it only uses ISO_IR 100 Specific Character Set in the worklist query requests.

2.8 Codes and Controlled Terminology

The product uses coded terminology as defined below.

2.8.1 Mapped Coded Terminology

The product maps, without change, coded terminology values supplied in Modality Worklist Scheduled Procedure Steps into Image SOP Instance and Modality Performed Procedure Step attributes, as described in Sections 6 and 7.

2.9 Security Profiles

The product does not conform to any defined DICOM Security Profiles.

It is assumed that the product is used within a secured environment. It is assumed that a secured environment includes at a minimum:

1. Firewall or router protections to ensure that only approved external hosts have network access to the product.
2. Firewall or router protections to ensure that the product only has network access to approved external hosts and services.
3. Any communications with external hosts and services outside the locally secured environment use appropriate secure network channels (such as a Virtual Private Network (VPN))

3 Media Storage Conformance Statement

3.1 Introduction

This conformance statement specifies the GEHC CT conformance to the DICOM Media Interchange. It details the DICOM Media Storage Application Profiles and roles that are supported by this product.

GEHC CT system provides capabilities to DICOM interchange on CD-R (Compact Disc - Recordable), CD-RW (Compact Disc - ReWritable), DVD-R (Digital Video Disc - Recordable), DVD-RW (Digital Video Disc - ReWritable) and USB (Universal Serial Bus) memory.

GEHC CT system works with most of the IOD's like Computed Tomography (CT), Magnetic Resonance (MR), Computed Radiography (CR), Positron Emission Tomography (PET), Digital X-Ray images, Structured Reporting (SR), X-Ray Dose SR, Grayscale Softcopy Presentation State (GSPS) and RT Structure Set.

3.2 Implementation Model

The DICOM Media Interchange Application Entity (AE) handles all DICOM media storage functionality on the GEHC CT system.

The DICOM Media Interchange AE is commanded to perform DICOM services through the buttons and menu selections on the user interface. It also uses the appropriate recorders to provide the service Interchange Media profiles.

3.2.1 Application Data Flow Diagram

The Basic and Specific Application models for the CD-R/CD-RW/DVD-R/DVD-RW/USB devices are shown in the following illustration.

The DICOM Media Interchange Application Entity (AE) handles the DICOM CREATE (CD/DVD/USB) / RESTORE CD (USB) / QUERY CD (USB) functionality for the CD/DVD/USB media. The DICOM Media Interchange Application Entity (AE) is commanded by the user to perform DICOM services operating on the DICOM media through the use of buttons and menu selections on the graphical user interface of the platform.

The user requests the creation of a DICOM File Set and the writing of this DICOM File Set on blank Interchange Media by selecting images in the local Browser and selecting the Interchange Media as being the selected device. Then, the iso9660 image of the CD/DVD to burn will be generated. Once the generation has been done, it burns the complete set of data on the selected Interchange Media. For USB Storage media with VFAT filesystem, DICOM File Set is copied to blank Interchange media.

The Media Interchange Application Model for the GEHC CT system is shown in Illustration 3-1:.

Illustration 3-1: Specific AE Application Model

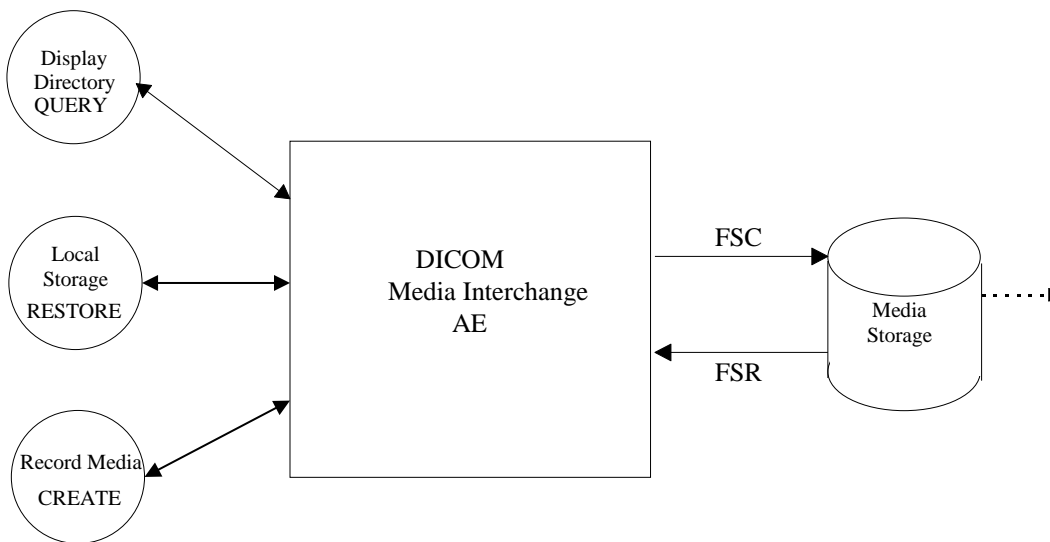

The DICOM Media Interchange AE has a local storage that may contain various SOP instances. These may have been obtained by original creation, network (DICOM or proprietary) or by removable media using other application entities. These instances are external to this conformance claim and the origin of SOP instances is outside the scope of this claim.

The DICOM Media Interchange AE initializes Media by acting as an FSC to create a new DICOM File-set on a 700MB CD/4.7GB DVD/USB Storage(no size limit) blank Interchange Media. . It initializes the DICOM File-set and writes all the specified SOP instances onto the Interchange Media at once. The SOP instances written will be limited to instances that match the criteria of one of the Application Profiles that is supported. Updating the media is not supported.

The DICOM Media Interchange AE acts as an FSR when requested to browse the Interchange Media such that user can select the SOP instances that he wants the DICOM Media Interchange AE to copy on the local database by selecting appropriate Study/Series/Image instances.

The supported file system during creation and restore are listed below:

TABLE 3.2.1-1

| File System | Supported during Media Create (FSC) | Supported during Media Restore (FSR) |
|--------------------|--|---|
| ISO 9660 | YES | YES |
| UDF | NO | YES |
| VFAT | YES | YES |

The supported media during creation and restore are listed below:

TABLE 3.2.1-2

| Media | Supported during Media Create (FSC) | File System supported (FSC) | Supported during Media Restore (FSR) | File System supported (FSR) |
|--------------------------------|--|------------------------------------|---|------------------------------------|
| CD -R | YES | ISO 9660 | YES | ISO 9660 |
| CD -RW | YES | ISO 9660 | YES | ISO 9660 |
| DVD -R | YES | ISO 9660 | YES | ISO 9660 & UDF |
| DVD -RW | YES | ISO 9660 | YES | ISO 9660 & UDF |
| USB Storage (VFAT file system) | YES | VFAT | YES | VFAT |

3.2.2 Functional Definitions of AE's

The CD-R/ CD-RW/DVD-R/DVD-RW/USB DICOM Media Interchange Application Entity support the following functions:

- Generate and write a DICOM File Set (FSC) in a one shot activity. (CREATE).
- Read a DICOM File Set (FSR) on an Interchange Media (QUERY).
- It can copy SOP instances from the media onto local storage. (RESTORE).

3.2.3 Sequencing of Real World Activities

The display function (QUERY) can only be performed on a piece of media that already had a DICOM File-set created. With no SOP instances having been added, the directory will be displayed empty.

The write function (CREATE) can only be performed on a blank (unused) Interchange Media. Updates to an already recorded Interchange Medium are not supported.

There are no other sequencing requirements.

3.2.4 File Meta Information for Implementation Class and Version

The File Meta-Information for this implementation is:

- File Meta-Information Version1
- Implementation Version NameSoftware Revision (See Appendix D)

The table in Appendix D identifies the Implementation UID for this product version.

3.3 AE Specifications

3.3.1 DICOM CD-R/CD-RW/DVD-R/DVD-RW/USB Media Interchange AE Specification

The DICOM CD-R/CD-RW/DVD-R/DVD-RW/USB Media Interchange AE provides standard conformance to DICOM Media Storage Service Class. The Application Profiles and roles are listed in Table 3.3.1-1.

Table 3.3.1-1: Supported Application Profiles and Roles

| Application Profiles Supported | Real World Activity | Role | SC Option |
|--------------------------------|---------------------|------|-------------|
| STD-GEN-CD | CREATE CD | FSC | Interchange |
| STD-GEN-CD | QUERY CD | FSR | Interchange |
| STD-GEN-CD | RESTORE CD | FSR | Interchange |
| STD-GEN-DVD-JPEG | CREATE DVD | FSC | Interchange |
| STD-GEN-USB-JPEG | CREATE USB | FSC | Interchange |
| STD-GEN-USB-JPEG | QUERY USB | FSR | Interchange |
| STD-GEN-USB-JPEG | RESTORE USB | FSR | Interchange |

Note: JPEG compressed images are supported for USB restore only.

3.3.1.1 File Meta Information for the CD-R/CD-RW/DVD-R/DVD-RW/USB DICOM Media Interchange Application Entity

Following are the values set in the File Meta Information for this AE. Please refer to Appendix D: **Implementation UID for Product Versions** for details on specific GEHC CT system information.

- Implementation UID : See Appendix D
- Implementation version name : See Appendix D

3.3.1.2 Real World Activities for the CD-R/CD-RW/DVD-R/DVD-RW/USB DICOM Media Interchange Application Entity

3.3.1.2.1 Real World Activity: Record Media - CREATE (CD/DVD/USB)

The DICOM Media Interchange Application acts as an FSC using the interchange option when requested to copy SOP Instances from the local database to a CD-R / CD-RW / DVD-R / DVD-R / USB.

The user selects the entries in the local database that he/she wants the DICOM Media Interchange Application to copy onto Interchange Media.

The graphic interface allows the user to select the entries (studies, series or images) in the local database to be copied onto to the selected Interchange Media.

The DICOM Media Interchange Application creates one File Set per generated Interchange Media.

- The graphic interface allows the user to select the entries (studies, series or images) in the local database to be copied onto to the selected Interchange Media.
- A user cannot create CD/DVD/USB while restore CD/USB is in process.

- A DICOM Media Viewer is provided along with the selected object instances on the interchange media. This viewer can be loaded on a standard PC running Windows XP, Windows Vista or Windows 7.

Before writing on the Interchange Media, the DICOM Media Interchange Application checks for the following condition:

- The inserted media is blank and write-able. If the condition is not met, an error is displayed and the user needs to replace it with a blank media.

Note:

Since JPEG compression is not enabled, the transfer syntax for SOP Instances will always be Explicit VR Little Endian (ELE) Uncompressed Transfer Syntax, UID 1.2.840.10008.1.2.1. For any other IODs with Transfer syntax other than ELE, the corresponding SOP instance data are converted to ELE and then copied to CD/DVD/USB. During the conversion to ELE, the private tags are stored with VR as UN if the syntax is implicit to facilitate fidelity.

The Object SOP instances have to be encoded with the ISO_IR 100 Specific Character set or DICOM Default Character Set.

3.3.1.2.1.1 Application Profiles for the RWA: Record Media - CREATE (CD/DVD/USB)

Refer to Table 3.3.1-1 for the list of Application Profiles that invoke this AE for the Create CD/DVD/USB RWA.

Refer to Table 3.3.1.2.1.1-1 below for the SOP Classes supported by the RWA “Create CD/DVD/USB”. All SOP Instances use the Explicit VR Little Endian Uncompressed Transfer Syntax, UID 1.2.840.10008.1.2.1 for creating CD/DVD/USB.

TABLE 3.3.1.2.1.1-1

| SOP Class | SOP Class UID |
|---|-------------------------------|
| CT Image Storage | 1.2.840.10008.5.1.4.1.1.2 |
| MR Image Storage | 1.2.840.10008.5.1.4.1.1.4 |
| PET Image Information Storage | 1.2.840.10008.5.1.4.1.1.128 |
| RT Structure Set Storage | 1.2.840.10008.5.1.4.1.1.481.3 |
| Secondary Capture Image Storage | 1.2.840.10008.5.1.4.1.1.7 |
| Grayscale Softcopy Presentation State Storage | 1.2.840.10008.5.1.4.1.1.11.1 |
| X-Ray Radiation Dose SR Image Storage | 1.2.840.10008.5.1.4.1.1.88.67 |

| | |
|---------------------|-------------------------------|
| Enhanced SR Storage | 1.2.840.10008.5.1.4.1.1.88.22 |
|---------------------|-------------------------------|

3.3.1.2.1.1.1 Options for STD-GEN-C D Application Profile:

Refer TABLE 3.3.1.2.1.1-1 for SOP Classes supported by this AE.

Common DICOMDIR Directory Records created by this AE will include key attributes as described in **Appendix C - DICOMDIR Directory Information.**

The following Additional DICOMDIR keys are supported for this profile in IMAGE Directory Records.

Table 3.3.1.2.1.1-1 Additional DICOMDIR Keys for STD-GEN-CD

| Key Attribute | Tag | Directory Record Type | Type | Notes |
|-------------------------------|-------------|-----------------------|------|--|
| Image Type | (0008,0008) | IMAGE | 1C | If present in composite object instances it will be set to same value, otherwise an error is returned. |
| Referenced Image Sequence | (0008,1140) | IMAGE | 1C | If present in composite object instances it will be set to same value, otherwise an error is returned. |
| > Referenced SOP Class UID | (0008,1150) | IMAGE | 1C | If present in composite object instances it will be set to same value, otherwise an error is returned. |
| > Referenced SOP Instance UID | (0008,1155) | IMAGE | 1C | If present in composite object instances it will be set to same value, otherwise an error is returned. |
| Rows | (0028,0010) | IMAGE | 3 | If present in composite object instances it will be set to same value, otherwise not stored. |
| Columns | (0028,0011) | IMAGE | 3 | If present in composite object instances it will be set to same value, otherwise not stored. |
| Frame of Reference UID | (0020,0052) | IMAGE | 3 | If present in composite object instances it will be set to same value, otherwise not stored. |
| Image Position Patient | (0020,0032) | IMAGE | 3 | If present in composite object instances it will be set to same value, otherwise not stored. |
| Image Orientation Patient | (0020,0037) | IMAGE | 3 | If present in composite object instances it will be set to same value, otherwise not stored. |
| Pixel Spacing | (0028,0030) | IMAGE | 3 | If present in composite object instances it will be set to same value, otherwise not stored. |

3.3.1.2.1.1.2 Options for STD-GEN-DVD-JPEG Application Profile:

Refer TABLE 3.3.1.2.1.1-1 for SOP Classes supported by this AE.

Common DICOMDIR Directory Records created by this AE will include key attributes as described in **Appendix C - DICOMDIR Directory Information.**

Following are the Additional DICOMDIR Keys supported for this profile:

Table 3.3.1.2.1.1.2-1 Additional DICOMDIR Keys for STD-GEN-DVD-JPEG

| Key Attribute | Tag | Directory Record Type | Type | Notes |
|-------------------------------|-------------|-----------------------|------|---|
| Patient's Birth Date | (0010,0030) | PATIENT | 1C | If present in composite object instances it will be set to same value, otherwise not present |
| Patient's Sex | (0010,0040) | PATIENT | 1C | If present in composite object instances it will be set to same value, otherwise not present |
| Institution Name | (0008,0080) | SERIES | 1C | If present in composite object instances it will be set to same value, otherwise not sent |
| Institution Address | (0008,0081) | SERIES | 1C | If present in composite object instances it will be set to same value, otherwise not sent |
| Performing Physician's Name | (0008,1050) | SERIES | 1C | If present in composite object instances it will be set to same value, otherwise not sent |
| Image Type | (0008,0008) | IMAGE | 1C | If present in composite object instances it will be set to same value, otherwise not sent |
| Calibration Image | (0050,0004) | IMAGE | 1C | If present in composite object instances it will be set to same value, otherwise not sent |
| Referenced Image Sequence | (0008,1140) | IMAGE | 1C | If present in composite object instances it will be set to same value, otherwise not sent |
| > Referenced SOP Class UID | (0008,1150) | IMAGE | 1C | If present in composite object instances it will be set to same value, otherwise not sent |
| > Referenced SOP Instance UID | (0008,1155) | IMAGE | 1C | If present in composite object instances it will be set to same value, otherwise not sent |
| Lossy Image Compression Ratio | (0028,2112) | IMAGE | 1C | If present in composite object instances it will be set to same value, otherwise not sent |
| Rows | (0028,0010) | IMAGE | 1 | If present in composite object instances it will be set to same value, otherwise an error is returned |
| Columns | (0028,0011) | IMAGE | 1 | If present in composite object instances it will be set to same value, otherwise an error is returned |

| | | | | |
|--|-------------|-------|----|---|
| Frame of Reference UID | (0020,0052) | IMAGE | 1C | If present in composite object instances it will be set to same value, otherwise not sent |
| Synchronization Frame of Reference UID | (0020,0200) | IMAGE | 1C | If present in composite object instances it will be set to same value, otherwise not sent |
| Number of Frames | (0028,0008) | IMAGE | 1C | If present in composite object instances it will be set to same value, otherwise not sent |
| Acquisition Time Synchronized | (0018,1800) | IMAGE | 1C | If present in composite object instances it will be set to same value, otherwise not sent |
| Acquisition DateTime | (0008,002A) | IMAGE | 1C | If present in composite object instances it will be set to same value, otherwise not sent |
| Image Position (Patient) | (0020,0032) | IMAGE | 1C | If present in composite object instances it will be set to same value, otherwise not sent |
| Image Orientation (Patient) | (0020,0037) | IMAGE | 1C | If present in composite object instances it will be set to same value, otherwise not sent |
| Pixel Spacing | (0028,0030) | IMAGE | 1C | If present in composite object instances it will be set to same value, otherwise not sent |

3.3.1.2.1.1.3 Options for STD-GEN-USB-JPEG Application Profile:

Refer TABLE 3.3.1.2.1.1-1 for SOP Classes supported by this AE.

Common DICOMDIR Directory Records created by this AE will include key attributes as described in **Appendix C - DICOMDIR Directory Information.**

Following are the Additional DICOMDIR Keys supported for this profile:

Table 3.3.1.2.1.1.3-1 Additional DICOMDIR Keys for STD-GEN-USB-JPEG

| Key Attribute | Tag | Directory Record Type | Type | Notes |
|-----------------------------|-------------|-----------------------|------|---|
| Patient's Birth Date | (0010,0030) | PATIENT | 1C | If present in composite object instances it will be set to same value, otherwise not sent |
| Patient's Sex | (0010,0040) | PATIENT | 1C | If present in composite object instances it will be set to same value, otherwise not sent |
| Institution Name | (0008,0080) | SERIES | 1C | If present in composite object instances it will be set to same value, otherwise not sent |
| Institution Address | (0008,0081) | SERIES | 1C | If present in composite object instances it will be set to same value, otherwise not sent |
| Performing Physician's Name | (0008,1050) | SERIES | 1C | If present in composite object instances it will be set to same value, otherwise not sent |
| Image Type | (0008,0008) | IMAGE | 1C | If present in composite object instances it will be set to same value, otherwise not sent |

| | | | | |
|--|-------------|-------|----|---|
| Calibration Image | (0050,0004) | IMAGE | 1C | If present in composite object instances it will be set to same value, otherwise not sent |
| Referenced Image Sequence | (0008,1140) | IMAGE | 1C | If present in composite object instances it will be set to same value, otherwise not sent |
| > Referenced SOP Class UID | (0008,1150) | IMAGE | 1C | If present in composite object instances it will be set to same value, otherwise not sent |
| > Referenced SOP Instance UID | (0008,1155) | IMAGE | 1C | If present in composite object instances it will be set to same value, otherwise not sent |
| Lossy Image Compression Ratio | (0028,2112) | IMAGE | 1C | If present in composite object instances it will be set to same value, otherwise not sent |
| Rows | (0028,0010) | IMAGE | 1 | If present in composite object instances it will be set to same value, otherwise an error is returned |
| Columns | (0028,0011) | IMAGE | 1 | If present in composite object instances it will be set to same value, otherwise an error is returned |
| Frame of Reference UID | (0020,0052) | IMAGE | 1C | If present in composite object instances it will be set to same value, otherwise not sent |
| Synchronization Frame of Reference UID | (0020,0200) | IMAGE | 1C | If present in composite object instances it will be set to same value, otherwise not sent |
| Number of Frames | (0028,0008) | IMAGE | 1C | If present in composite object instances it will be set to same value, otherwise not sent |
| Acquisition Time Synchronized | (0018,1800) | IMAGE | 1C | If present in composite object instances it will be set to same value, otherwise not sent |
| Acquisition DateTime | (0008,002A) | IMAGE | 1C | If present in composite object instances it will be set to same value, otherwise not sent |
| Image Position (Patient) | (0020,0032) | IMAGE | 1C | If present in composite object instances it will be set to same value, otherwise not sent |
| Image Orientation (Patient) | (0020,0037) | IMAGE | 1C | If present in composite object instances it will be set to same value, otherwise not sent |
| Pixel Spacing | (0028,0030) | IMAGE | 1C | If present in composite object instances it will be set to same value, otherwise not sent |

3.3.1.2.1.1.4 FSC Directory Options

Refer to Appendix C: **DICOMDIR Directory Information** for a complete listing of all modules and attributes used in the DICOMDIR definition.

NOTE:

Modality attribute (0008,0060) in the DICOMDIR Series records should be “CT” for Secondary Capture SOP Class Images. Otherwise the GEHC CT system’s DICOM media display browser will not list-up the series for contents rendering the retrieval to local storage impossible.

For USB, only one DICOM file set shall be stored in the first partition of a partitioned device. If the device is not partitioned, only one DICOM file set shall be stored on the device.

3.3.1.2.2 Real World Activity: Display Directory – QUERY (CD/USB)

The DICOM Media Interchange AE acts as an FSR using the interchange option when requested to browse the Interchange Media.

When the DICOM Media Interchange AE is requested to provide a directory listing, it reads the File-set and displays the DICOMDIR directory entries, according to the STUDY Root paradigm.

If the media is not blank, then Interchange Media gets mounted. To remove the media, the user has to select the eject button on user interface for the appropriate drive.

A user cannot display the directory when create CD/DVD/USB or restore CD/USB are in progress.

3.3.1.2.2.1 Application Profiles for the RWA: Display Directory

For the list of Application Profiles that invoke this AE for the Display Directory CD/USB RWA,, see Table 3.3.1-1.

There are no extensions or specializations.

3.3.1.2.2.2 Media Storage Application Profile for the RWA: Display Directory:

Following are the SOP Classes supported by the RWA “Display Directory of CD/USB”:

| Information Object Definition | SOP Class UID | Transfer Syntax | Transfer Syntax UID |
|---------------------------------|----------------------|---------------------------|---------------------|
| Media Storage Directory Storage | 1.2.840.10008.1.3.10 | Explicit VR Little Endian | 1.2.840.10008.1.2.1 |

3.3.1.2.3 Real World Activity (RWA): Local Storage – RESTORE (CD/USB)

The CD/USB DICOM Media Interchange AE acts as an FSR using the interchange option when requested to copy SOP instances from the CD/USB to the local database.

The user selects the SOP instances that he wants the DICOM Media Interchange AE to copy on the local database by selecting appropriate Study/Series/Image instances and clicking on the suitable restore buttons. Once selected, the SOP instances are copied from the media to the local database.

If the media is not blank, then the Interchange Media gets mounted. To remove the media, the user has to select the eject button on the User Interface for the appropriate drive.

A user cannot restore CD/USB while create CD/DVD/USB is in process.

A user can only restore selected composite objects at a time from a media; any other attempt of selections to restore CD/USB on media in same drive will wait until the first one is completed.

3.3.1.2.3.1 Application Profiles for the RWA: Local Storage – RESTORE (CD/USB)

For the list of Application Profiles that invoke this AE for the Restore RWA, see Table 3.3.1-1. For extensions and specialization’s see section 3.5.

3.3.1.2.3.1.1 Options for STD-GEN-CD and STD-GEN-USB-JPEG Application Profile:

Common DICOMDIR Directory Records read by this AE will include key attributes as described in Appendix C.

Following are the SOP Classes supported by the RWA “Local Storage – RESTORE (CD/USB)”.

| Information Object Definition | SOP Class UID | Transfer Syntax | Transfer Syntax UID |
|---------------------------------|-------------------------|--|------------------------|
| Media Storage Directory Storage | 1.2.840.10008.1.3.10 | Explicit VR Little Endian | 1.2.840.10008.1.2.1 |
| See Table 3.3.1.2.1.1-1 | See Table 3.3.1.2.1.1-1 | Explicit VR Little Endian | 1.2.840.10008.1.2.1 |
| See Table 3.3.1.2.1.1-1 | See Table 3.3.1.2.1.1-1 | JPEG Lossless Process 14 (selection value 1) (STD-GEN-USB-JPEG only) | 1.2.840.10008.1.2.4.70 |
| See Table 3.3.1.2.1.1-1 | See Table 3.3.1.2.1.1-1 | JPEG Lossy, Baseline Sequential with Huffman Coding (Process 1) (STD-GEN-USB-JPEG only) | 1.2.840.10008.1.2.4.50 |
| See Table 3.3.1.2.1.1-1 | See Table 3.3.1.2.1.1-1 | JPEG Extended (Process 2 & 4): Default Transfer Syntax for Lossy JPEG 12 Bit Image Compression (Process 4 only) (STD-GEN-USB-JPEG only) | 1.2.840.10008.1.2.4.51 |

3.4 Augmented and Private Application Profiles

3.4.1 Augmented Application Profiles

The CD/DVD/USB Media Archive Interchange AE does not support any augmented Application Profiles.

3.4.2 Private Application Profiles

The CD/DVD/USB Media Interchange AE does not support any private Application Profiles

3.5 Extensions, Specializations and Privatization of SOP Classes and Transfer Syntax

3.5.1 Extensions, Specialization's and Privatizations of SOP Classes

The CT/MR SOP Class Images have definitions extended for Defined Terms and include GE specific Private Data elements. The following sections describe the details for these SOP classes.

3.5.1.1 SOP Specific Conformance Statement for Basic Directory SOP Class

Following attributes are Standard extensions for each Directory Record type.

| Key Attribute | Tag | Directory Record Type |
|---------------------------|-------------|--------------------------------------|
| Image Type | (0008,0008) | SERIES IMAGE |
| Manufacturer's ID | (0008,0070) | SERIES |
| Series Description | (0008,103E) | SERIES |
| Manufacturer's Model Name | (0008,1090) | SERIES |
| SOP Instance UID | (0008,0018) | IMAGE PRESENTATION SR DOCUMENT |
| Acquisition Time | (0008,0032) | IMAGE |
| Slice Thickness | (0018,0050) | IMAGE |
| Spacing Between Slices | (0018,0088) | IMAGE |
| Data Collection Diameter | (0018,0090) | IMAGE |
| Reconstruction Diameter | (0018,1100) | IMAGE |
| Gantry/Detector Tilt | (0018,1120) | IMAGE |
| Convolution Kernel | (0018,1210) | IMAGE |
| Slice Location | (0020,1041) | IMAGE |

Refer to Appendix B: **Private Data Elements** for private data elements.

3.5.2 Private Transfer Syntax Specification

None specified.

3.6 Configuration

For the CD/DVD/USB Interchange Media Application, the source AE Title encoded in the File Meta-Information cannot be modified.

3.7 Support of Extended Character Sets

The CD/DVD/USB Interchange Media Application will support copy of SOP instances containing the ISO IR 100 (Latin alphabet No. 1, supplementary set) and DICOM default character sets as defined in PS3.5.

Any incoming SOP instances encoded using another extended character set will not be installed in the GEHC CT system database

3.8 IHE Integration

3.8.1 IHE PDI

The CT system supports the Integrating the Healthcare Enterprise (IHE) Portable Data for Imaging (PDI) Profile as Portable Media Creator actor.

Table 3.8.1-1 lists the IHE PDI profile options supported by Portable Media Creator.

Table 3.8.1-1 Support of IHE PDI profile as Portable Media Creator

| Option | Support |
|--------------------|---------|
| Write to DVD Media | Yes |
| Write to USB Media | Yes |
| Add Basic Viewer | Yes |
| Media Labeling | Yes |
| Privacy Protection | No |
| Sending Software | No |
| WEB Content | No |

4 Print Management Implementation

4.1 Introduction

This section of conformance Statement specifies the implementation for the specific SOP Classes supported in the Basic Grayscale and Color Print Management Meta SOP Classes, the attributes supported for both IODs and services, and the valid range of values for mandatory and optional attributes.

4.2 Basic Film Session SOP Class

The Print SCU supports the following DIMSE Service Elements for the Basic Film Session SOP Class.

- N-CREATE – Requests the Print SCP to create an instance of Basic Film Session.

4.2.1 Basic Film Session N-Create Attributes

The following Attribute values are supported by the N-CREATE:

| Attribute name | Tag | Use |
|------------------------|-------------|---------------------------------------|
| Specific Character Set | (0008,0005) | Not used |
| *Number of Copies | (2000,0010) | Set by user. Valid range is : 1-99 |

| | | |
|--------------------|-------------|---|
| *Print Priority | (2000,0020) | Set when a printer device is added using the Film Composer Tool. Default value is HIGH. Set in Configuration file Valid Range is : HIGH or MED or LOW |
| *Medium Type | (2000,0030) | Set when a printer device is added using the Film Composer Tool. Set in Configuration File Valid values are : PAPER or CLEAR FILM or BLUE FILM |
| *Film Destination | (2000,0040) | Set when a printer device is added using the Film Composer Tool. Set in Configuration File Valid values are : MAGAZINE or PROCESSOR |
| Film Session Label | (2000,0050) | Not used. |
| Memory Allocation | (2000,0060) | Not used. |
| Owner ID | (2100,0160) | Not used. |

Note: * denotes that the attribute is optional for the SCU. However, we do provide values for all of these optional attributes and if the SCP does not support the requested value it may choose to either return a failure status or ignore the value provided and use its default value.

4.3 Basic Film Box SOP Class

The Print SCU supports the following DIMSE Service Elements for the Basic Film Box SOP Class.

- N-CREATE – Requests the Print SCP to create an instance of Film Box.
- N-ACTION – Requests the Print SCP to print the Film Box onto Printer.
- N-DELETE – Requests the Print SCP to delete the Film Box Instance.

4.3.1 Basic Film Box N-Create Attributes

This table lists the attributes that are sent to the SCP in the Basic Film Box N-Create Request, and that are received in the Basic Film Box N-Create Response from the SCP

| Attribute Name | Tag | Use |
|----------------------------------|-------------|---|
| Image Display Format | (2010,0010) | Set in User Interface. Valid Range: STANDARD\C,R |
| Referenced Film Session Sequence | (2010,0500) | Sent in the request |
| >Referenced SOP Class UID | (0008,1150) | Film session SOP Class UID (1.2.840.10008.5.1.1.1) |
| >Referenced SOP Instance UID | (0008,1155) | Film session SOP instance UID |

| | | |
|-------------------------------|-------------|--|
| Referenced Image Box Sequence | (2010,0510) | Used in Image Box N-SET request |
| >Referenced SOP Class UID | (0008,1150) | |
| >Referenced SOP Instance UID | (0008,1155) | |
| *Film Orientation | (2010,0040) | Set when a printer device is added using the Film Composer Tool. Set in Configuration File. Valid value is : PORTRAIT. |
| Film Size ID | (2010,0050) | Set when a printer device is added using the Film Composer Tool. Valid values are : 14INX17IN, A3, A4, 8INX10IN, 8.5INX11IN, 10INX12IN, 10INX14IN, 11INX14IN, 11INX17IN, 14INX14IN, 24CMX24CM, 24CMX30CM. |
| *Magnification Type | (2010,0060) | Set when a printer device is added using the Film Composer Tool. Set in Configuration File. Valid values are: REPLICATE BILINEAR CUBIC NONE |
| *Max Density | (2010,0130) | Set when a printer device is added using the Film Composer Tool. Set in Configuration File. Valid range is : 0-4095. |
| Configuration Information | (2010,0150) | Set when a printer device is added using the Film Composer Tool |
| Annotation Display Format ID | (2010,0030) | Not Supported. |
| *Smoothing Type | (2010,0080) | Set when a printer device is added using the Film Composer Tool. Set in Configuration File. |
| *Border Density | (2010,0100) | Set when a printer device is added using the Film Composer Tool. Set in Configuration File. Valid values are: BLACK or WHITE or Not sent |
| *Empty Image Density | (2010,0110) | Set when a printer device is added using the Film Composer Tool. Set in Configuration File. |

| | | |
|-------------------------|-------------|--|
| | | Valid values are: BLACK or WHITE or Not sent |
| *Min Density | (2010,0120) | Set when a printer device is added using the Film Composer Tool. Set in Configuration File. Valid values are: 0-4095 or Not sent |
| *Trim | (2010,0140) | Valid values are: YES or NO or Not Sent Default value : NO |
| Illumination | (2010,015E) | Not Supported. |
| Reflected Ambient Light | (2010,0160) | Not Supported. |
| Requested Resolution ID | (2020,0050) | Not Supported. |
| ICC Profile | (0028,2000) | Not Supported. |

4.3.2 Basic Film Box N-Action Attributes

Following are the Action reply arguments that are supported if present in the N-Action response of the Basic Film Box SOP Class

| Action Type Name | Action Type ID | Attribute | Tag | Usage SCU |
|------------------|----------------|-------------------------------|-------------|---------------|
| Print | 1 | Referenced Print Job Sequence | (2100,0500) | Ignored |
| | | >Referenced SOP Class UID | (0008,1150) | Ignored |
| | | >Referenced SOP Instance UID | (0008,1155) | Ignored |
| | | >Print Job ID | (2100,0010) | Not supported |

4.3.3 Basic Film Box N-Delete

The DICOM SERVER AE requests the Print SCP to delete the Film Box Instance.

Note: * denotes that the attribute is optional for the SCU. However, we do provide values for all of these optional attributes and if the SCP does not support the requested value it may choose to either return a failure status or ignore the value provided and use its default value.

4.4 Basic Grayscale Image Box SOP Class

The Print SCU supports the following DIMSE Service Elements for Grayscale Image Box SOP Class.

- N-SET – Requests the Printer to set the image box attributes.

This table lists the attributes that are sent in the Basic Grayscale Image Box N-Set Request:

| Attribute Name | Tag | Use |
|--------------------------------------|-------------|---|
| Image Position | (2020,0010) | Based on Image Display Format |
| Basic Grayscale Image Sequence | (2020,0110) | Sent in the request |
| >Samples Per Pixel | (0028,0002) | 1 |
| >Photometric Interpretation | (0028,0004) | MONOCHROME2 |
| >Rows | (0028,0010) | Image Dependent |
| >Columns | (0028,0011) | Image Dependent |
| >Pixel Aspect Ratio | (0028,0034) | 1\1 |
| >Bits Allocated | (0028,0100) | 8 (if Bits Stored=8) or 16 (if Bits Stored=12) |
| >Bits Stored | (0028,0101) | 8 or 12. Default value: 8 |
| >High Bit | (0028,0102) | 7 (if Bits Stored=8) or 11 (if Bits Stored=12) |
| >Pixel Representation | (0028,0103) | 0 (unsigned integer) |
| >Pixel Data | (7FE0,0010) | Pixel data |
| *Polarity | (2020,0020) | NORMAL |
| Magnification Type | (2010,0060) | BILINEAR CUBIC REPLICATE NONE |
| Smoothing Type | (2010,0080) | Printer Dependent |
| Min Density | (2010,0120) | 0-4095, Not Sent |
| Max Density | (2010,0130) | 0-4095 |
| Configuration Information | (2010,0150) | Printer Dependent |
| Requested Image Size | (2020,0030) | Not used |
| Requested Decimate/Crop Behavior | (2020,0040) | Not used |
| Referenced Presentation LUT Sequence | (2050,0500) | Not supported. |
| > Referenced SOP Class UID | (0008,1150) | Not supported. |
| > Referenced SOP Instance UID | (0008,1155) | Not supported. |

Note: * denotes that the attribute is optional for the SCU. However, we do provide values for all of these optional attributes and if the SCP does not support the requested value it may choose to either return a failure status or ignore the value provided and use its default value.

4.5 Basic Color Image Box SOP Class

The Print SCU supports the following DIMSE Service Elements for Basic Color Image Box SOP Class.

- N-SET - Requests the Printer to set the image box attributes.

This table lists the attributes that are sent in the Basic Color Image Box N-Set Request:

| Attribute Name | Tag | Use |
|----------------------------------|-------------|--|
| Image Position | (2020,0010) | Based on Image Display Format |
| Basic Color Image Sequence | (2020,0111) | |
| >Samples Per Pixel | (0028,0002) | 3 |
| >Photometric Interpretation | (0028,0004) | RGB |
| >Planar Configuration | (0028,0006) | 1 |
| >Rows | (0028,0010) | Image Dependent |
| >Columns | (0028,0011) | Image Dependent |
| >Pixel Aspect Ratio | (0028,0034) | 1/1 |
| >Bits Allocated | (0028,0100) | 8 |
| >Bits Stored | (0028,0101) | 8 |
| >High Bit | (0028,0102) | 7 |
| >Pixel Representation | (0028,0103) | 0 (unsigned integer) |
| >Pixel Data | (7FE0,0010) | Pixel data |
| *Polarity | (2020,0020) | NORMAL |
| Magnification Type | (2010,0060) | BILINEAR CUBIC REPLICATE NONE |
| Smoothing Type | (2010,0080) | Printer Dependent |
| Requested Image Size | (2020,0030) | Not used |
| Requested Decimate/Crop Behavior | (2020,0040) | Not used |

4.6 Printer SOP Class

N-GET DIMSE service is supported for the Printer SOP Class. If an N-EVENT-REPORT DIMSE service is received when the association is active, Print SCU handles the relevant states but the data received is ignored.

This table defines the set of attributes that this product may request using the Printer N-Get service. It also describes the product behavior when receiving the N-Get response from the Printer SCP:

| Attribute Name | Tag | Use |
|--------------------------|-------------|--|
| Printer Status | (2110,0010) | <p>NORMAL: Status is logged and sends Film Session N-CREATE request.</p> <p>WARNING: Status is logged. Pauses the print job and displays status code on the film composer UI.</p> <p>FAILURE: Status is logged. Pauses the print job and displays print failure message on the film composer UI.</p> |
| Printer Status Info | (2110,0020) | <p>SUPPLY LOW: Logs the message and continues printing.</p> <p>SUPPLY EMPTY: print job is paused and the message is logged.</p> <p>RECEIVER FULL: print job is paused and the message is logged.</p> <p>FILM JAM: print job is paused and the message is logged.</p> |
| Printer Name | (2110,0030) | Logged if sent by SCP |
| Manufacturer | (0008,0070) | Logged if sent by SCP |
| Manufacturer Model Name | (0008,1090) | Logged if sent by SCP |
| Device Serial Number | (0018,1000) | Logged if sent by SCP |
| Software Versions | (0018,1020) | Logged if sent by SCP |
| Date Of Last Calibration | (0018,1200) | Ignored |
| Time Of Last Calibration | (0018,1201) | Ignored |

5 Storage Commitment Push Model Implementation

5.1 Storage Commitment Push Model Information Object Definition

Please refer to DICOM Part 3 (Information Object Definitions) for a description of each of the attributes contained within the Storage Commitment Information Object.

The Storage Commitment Information Object is used both for N-ACTION Storage Commitment Requests and N-EVENT-REPORT Storage Commitment Notifications by the SCU.

5.1.1 Storage Commitment Module for N-ACTION

Table – 5.1.1-1 Storage Commitment Module for N-ACTION

| Attribute Name | Tag | SCU Use |
|------------------------------|-------------|--------------------------|
| Transaction UID | (0008,1195) | Generated for each retry |
| Storage Media File-Set ID | (0088,0130) | Not supported |
| Storage Media File-Set UID | (0088,0140) | Not supported |
| Referenced SOP Sequence | (0008,1199) | |
| >Referenced SOP Class UID | (0008,1150) | |
| >Referenced SOP Instance UID | (0008,1155) | |
| >Storage Media File-Set ID | (0088,0130) | Not supported |
| >Storage Media File-Set UID | (0088,0140) | Not supported |

5.1.2 Storage Commitment Module for N-EVENT-REPORT

Table – 5.1.2-1 Storage Commitment Module for N-EVENT-REPORT

| Attribute Name | Tag | SCU Use |
|----------------------------|-------------|-------------------------|
| Transaction UID | (0008,1195) | Value received from SCP |
| Retrieve AE Title | (0008,0054) | Not used |
| Storage Media File-Set ID | (0088,0130) | Not used |
| Storage Media File-Set UID | (0088,0140) | Not used |

| | | |
|------------------------------|-------------|---|
| Referenced SOP Sequence | (0008,1199) | When status is SUCCESS, the “Archived” flag value for the referenced SOP instances is changed to “Yes” in the browser. In case of partial failure, the archival status of a series is updated only if all the images of the series are archived successfully. Archive status of series is not updated if archiving of one or more images of the series failed. Image level archive status updation is not supported. |
| >Referenced SOP Class UID | (0008,1150) | |
| >Referenced SOP Instance UID | (0008,1155) | |
| >Retrieve AE Title | (0008,0054) | Not used. |
| >Storage Media File-Set ID | (0088,0130) | Not used |
| >Storage Media File-Set UID | (0088,0140) | Not used |
| Failed SOP Sequence | (0008,1198) | “Archived” flag value for the failed SOP instance is unaltered. Failed SOP instances are logged. |
| >Referenced SOP Class UID | (0008,1150) | |
| >Referenced SOP Instance UID | (0008,1155) | |
| >Failure Reason | (0008,1197) | Not used. |

5.1.2.1 Processing of Failure Reason when received in a N-Event-Report

When receiving a N-Event-Report request with Event Type ID equal to 2, meaning that Storage Commitment is complete, but failure exists, following is the set of value that this Storage Commitment SCU AE is able to process.

| Failure Reason | Meaning | Application Behavior When Receiving Reason Code |
|----------------|------------------------------------|--|
| 0110H | Processing failure | Log file updated: Processing Failure. Job failed. |
| 0112H | No such object instance | Log file updated: No such object instance. Job failed. |
| 0213H | Resource limitation | Log file updated: resource limitation. Job failed. |
| 0122H | Referenced SOP Class not supported | Log file updated: reference SOP class not supported. Job failed. |
| 0119H | Class / Instance conflict | Log file updated: class/instance conflict. Job failed. |
| 0131H | Duplicate transaction UID | Log file updated: duplicate transaction UID. Job failed. |

| | | |
|---|----------------------------------|--|
| * | Other Failure Reason code values | Log file updated: unknown failure. Job failed. |
|---|----------------------------------|--|

6 Modality Worklist Query Implementation

6.1 Modality Worklist Information Model Definition

6.1.1 Introduction

This section specifies the use of the DICOM Modality Worklist Information Model used to organize data and against which a Modality Worklist Query will be performed.

6.1.2 Modality Worklist Information Model Description

In order to serve as a Service Class Provider (SCP) of the Modality Worklist Service Class, a DICOM Application Entity (AE) possesses information about the attributes of a number of managed worklist items. These items are organized into Modality Worklist Information Modules. In this Service Class, the Information Model plays a role similar to an Information Object Definition of most other DICOM Service Classes.

6.1.3 Modality Worklist Information Model Entity-Relationship Model

The Entity-Relationship diagram for the Modality Worklist Information Model schema is shown in Illustration 6.1.3-1. It represents the information that composes a Worklist Item. In this figure, the following diagrammatic convention is established to represent the information organization:

- Each entity is represented by a rectangular box
- Each relationship is represented by a diamond shaped box.
- The fact that a relationship exists between two entities is depicted by lines connecting the corresponding entity boxes to the relationship boxes.

Illustration 6.1.3-1 – Modality Worklist Information Model E/R DIAGRAM

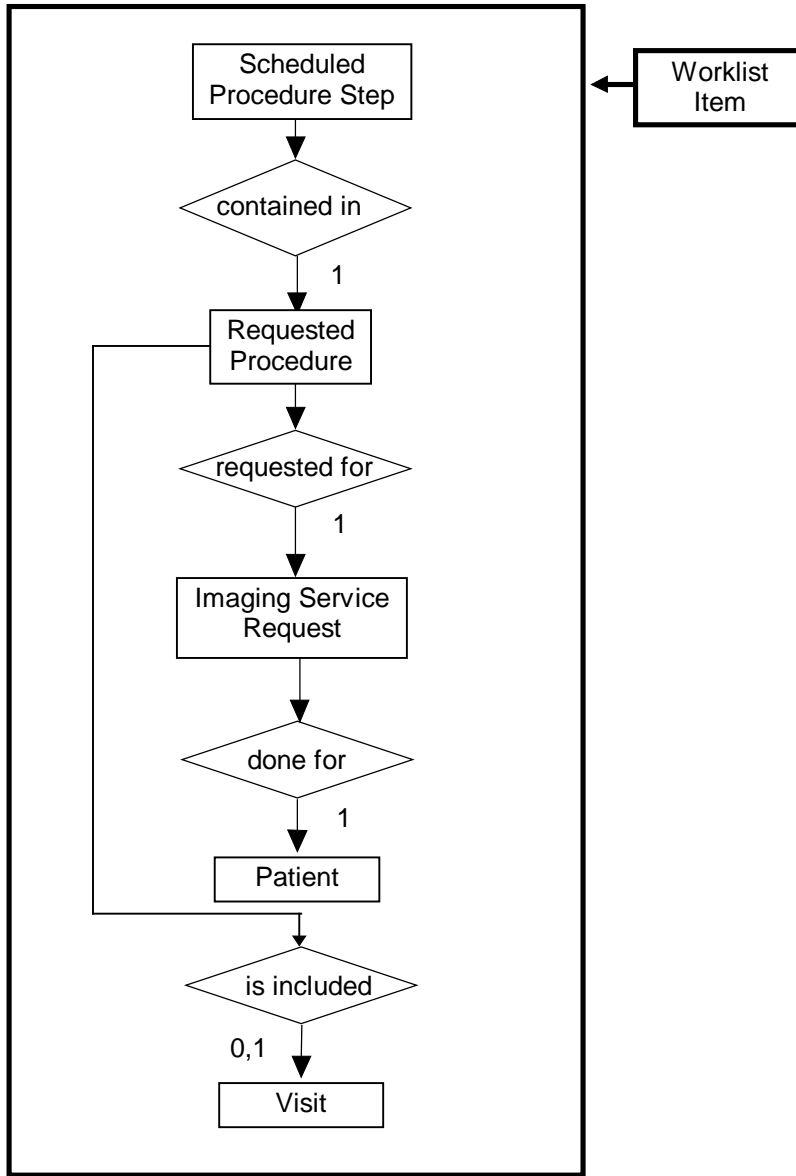

6.1.3.1 Entity Descriptions

Please refer to DICOM Standard PS 3.3. (Information Object Definitions) and PS 3.4 (Service Class Specifications) for a description of each of the Entities contained within the Modality Worklist Information Model.

6.1.3.1.1 Scheduled Procedure Step

A Scheduled Procedure Step is an arbitrarily defined scheduled unit of service that is specified by the Procedure Plan for a Requested Procedure. It specifies one or more Action Items (events) involving equipment (i.e. imaging modality equipment), human resources, location and time (i.e. start time, stop time, duration).

6.1.3.1.2 Requested Procedure Entity Description

A Requested Procedure is an instance of a Procedure of a given Procedure Type. An instance of a Requested Procedure includes all of the items of information that are specified by an instance of a Procedure Plan that is selected for the Requested Procedure by the imaging service provider.

6.1.3.1.3 Imaging Service Request Entity Description

An Imaging Service Request is a set of one or more Requested Procedures selected from a list of Procedure Types. An Imaging Service Request is submitted by one authorized imaging service requester to one authorized imaging service provider in the context of one Service Episode.

6.1.3.1.4 Visit Entity Description

A Visit is the context in which the treatment or management of an arbitrary subset of a Patient's medical conditions occurs. A Visit is limited to the description of a Patient's activities at a single facility.

6.1.3.1.5 Patient Entity Description

A Patient is a person receiving, or registered to receive healthcare services.

6.1.4 ModalityWorklist Mapping of DICOM Entities

Table 6.1.4-1 — Mapping of DICOM Entities to ModalityWorklist Entities

| DICOM | ModalityWorklist Entity |
|--------------------------|-------------------------|
| Scheduled Procedure Step | Exam |
| Requested Procedure | Exam |
| Imaging Service Request | Exam |
| Visit | Exam |
| Patient | Patient |

6.1.5 Modality Worklist Information Model Module

Within an entity of the DICOM Modality Worklist Information Model, attributes are grouped together into related set of attributes called modules. A module facilitates the understanding of the semantics concerning the attributes and how the attributes relate to one another. A module grouping does not infer any encoding of information into datasets.

Table 6.1.5-1 identifies the defined modules within the entities that comprise the DICOM Modality Worklist Information Model. Modules are identified by Module Name.

See DICOM PS 3.3 and PS 3.4 for a complete definition of the entities, modules, and attributes.

Table 6.1.5-1 – Modality Worklist Information Model Modules

| Entity Name | Module Name | Reference |
|--------------------------|--------------------------|-----------|
| Scheduled Procedure Step | SOP Common | 6.1.6.2.1 |
| | Scheduled Procedure Step | 6.1.6.2.2 |
| Requested Procedure | Requested Procedure | 6.1.6.3.1 |
| Imaging Service Request | Imaging Service Request | 6.1.6.4.1 |
| Visit | Visit Identification | 6.1.6.5.1 |
| | Visit Status | 6.1.6.5.2 |
| | Visit Relationship | 6.1.6.5.3 |
| | Visit Admission | 6.1.6.5.4 |
| Patient | Patient Relationship | 6.1.6.6.1 |
| | Patient Identification | 6.1.6.6.2 |
| | Patient Demographic | 6.1.6.6.3 |
| | Patient Medical | 6.1.6.6.4 |

6.1.6 Information Model Keys

Please refer to DICOM Standard PS 3.3. (Information Object Definitions) and PS 3.4 (Service Class Specifications) for a description of each of the Entities contained within the Modality Worklist Information Model.

The following Module descriptions contain the attributes that are present in a C-FIND request message sent by the Worklist Server AE to a remote AE. It should be noted that they are the same as those defined in the DICOM Standard, PS 3.4 (Service Class Specifications) and include:

- **Attribute Name**
- **Tag:** group and element numbers
- **Expected Matching Key Type:** R-required, O-optional
- **Expected Return Key Type:**
 - 1 - non-zero value required
 - 1C - conditionally of type 1
 - 2 - required to be present, possibly with zero-length value
 - 3 - optional
- **Mapped into The Image:** whether this data is mapped into subsequently acquired images
- **Notes:** clarification of this implementation’s use/treatment of this attribute

All data elements in the following Module descriptions are requested by the Worklist Server AE. Values of data elements that are not mapped into images, and are not otherwise dealt with (displayed on the user interface, etc.), are not used and are, thus, discarded upon receipt. See Table B-1 for further information.

Data elements for which values can be sent for matching purposes are described as such. Data elements for which values are not sent are sent with zero length and universal matching will apply. This is the default case if no other description to the contrary is provided.

6.1.6.1 Supported Matching

The following are the types of matching that can be request by the implementation:

- Single Value matching
- Universal Matching
- Range of date/time

6.1.6.2 Scheduled Procedure Step Entity

6.1.6.2.1 SOP Common Module

Table 6.1.6.2.1-1 – SOP Common Module Attributes

| Attribute Name | Tag | Expected Matching Key Type | Expected Returned Key Type | Mapped into the Image/MPPS | Note |
|------------------------|-------------|----------------------------|----------------------------|----------------------------|--|
| Specific Character Set | (0008,0005) | O | 1C | No/No | This value is always sent. ISO_IR_100 is the default value sent during querying if not set explicitly. Product uses the value returned if it is set in the response. |

6.1.6.2.2 Scheduled Procedure Step Module

Table 6.1.6.2.2-1 – Scheduled Procedure Step Module Attributes

| Attribute Name | Tag | Expected Matching Key Type | Expected Returned Key Type | Mapped into the Image/MPPS | Note |
|-----------------------------------|-------------|----------------------------|----------------------------|----------------------------|---|
| Scheduled Procedure Step Sequence | (0040,0100) | R | 1 | No/No | Requested in the MWL queries. |
| Scheduled Station AE Title | (0040,0001) | R | 1 | No/No | Matching is supported as follows: either no AE title is supplied (universal matching), or the scanner's Worklist Server AE title is supplied for matching; this is user selectable. |

| | | | | | |
|---------------------------------------|-------------|---|----|---------|--|
| Scheduled Procedure Step Start Date | (0040,0002) | R | 1 | No/No | Matching is supported as one of the following; this is user selectable: <ul style="list-style-type: none"> • all days, • today only, • today and a number of days before today, • today and a number of days after today, • today and a number of days before today and a number of days after today. Number of days before/after is specified by the user. Returned values must be exactly 8 numeric characters in YYYYMMDD format. |
| Scheduled Procedure Step Start Time | (0040,0003) | R | 1 | No/No | This attribute is sent with zero-length. Returned values must be exactly 6 numeric characters in HHMMSS format. |
| Modality | (0008,0060) | R | 1 | Yes/Yes | Matching is supported as follows: either no Modality is supplied (universal matching), or the scanner's Modality is supplied for matching; this is user selectable. |
| Scheduled Performing Physician's Name | (0040,0006) | R | 2 | Yes/Yes | This attribute is sent with zero-length. This value is mapped into (0008, 1050) in the image header and in MPPS. |
| Scheduled Procedure Step Description | (0040,0007) | O | 1C | Yes/Yes | |
| Scheduled Station Name | (0040,0010) | O | 2 | No/No | |
| Scheduled Procedure Step Location | (0040,0011) | O | 2 | No/No | |
| Scheduled Protocol Code Sequence | (0040,0008) | O | 1C | Yes/Yes | Up to 5 Scheduled Protocol Code Sequence Items are mapped into the image if they system is configured to support GSPS. |
| Code Value | (0008,0100) | O | 1C | Yes/No | |
| Coding Scheme Designator | (0008,0102) | O | 1C | Yes/No | |
| Code Meaning | (0008,0104) | O | 3 | Yes/No | NOTE: though type 3, the scanner expects Code Meaning to be sent if (0040,0008) is sent. |
| Pre-Medication | (0040,0012) | O | 2C | No/No | |

| | | | | | |
|-----------------------------|-------------|---|----|---------|-------------------------------------|
| Scheduled Procedure Step ID | (0040,0009) | O | 1 | Yes/Yes | |
| Requested Contrast Agent | (0032,1070) | O | 2C | No/No | Displayed on "More Info..." screen. |

6.1.6.3 Requested Procedure Entity

6.1.6.3.1 Requested Procedure Module

Table 6.2.6.3.1-1 Requested Procedure Module Attributes

| Attribute Name | Tag | Expected Matching Key Type | Expected Returned Key Type | Mapped into the Image/MPPS | Note |
|-----------------------------------|-------------|----------------------------|----------------------------|----------------------------|---|
| Requested Procedure ID | (0040,1001) | O | 1 | Yes/Yes | User can enter the value for Requested Procedure Id prior to query. If user has entered the value then that value will be sent as part of the query. The value returned in the response shall be mapped to the image. |
| Requested Procedure Description | (0032,1060) | O | 1C | Yes/Yes | Truncated to 22 characters by default however this is configurable to allow 64 characters. |
| Requested Procedure Code Sequence | (0032,1064) | O | 1C | Yes/No | |
| Code Value | (0008,0100) | O | 1C | Yes/No | |
| Coding Scheme Designator | (0008,0102) | O | 1C | Yes/No | |
| Code Meaning | (0008,0104) | O | 3 | Yes/No | NOTE: thought type 3, the scanner expects Code Meaning to be sent if (0032,1064) is sent. |

| Attribute Name | Tag | Expected Matching Key Type | Expected Returned Key Type | Mapped into the Image/MPPS | Note |
|--------------------------------|-------------|----------------------------|----------------------------|--------------------------------|---|
| Study Instance UID | (0020,000D) | O | 1 | Yes (Based on User option)/Yes | User (Modality) will be able to configure the following. If the user has set the option to "Use MWL Study UID", then study Instance UID will be copied into the final DICOM image header. If this option is not set then a new Study instance UID is generated locally on the scanner. The default setting is to generate a new study instance uid if a worklist entry is re-used however it can be configured to reuse the same study instance uid. |
| Referenced Study Sequence | (0008,1110) | O | 2 | Yes/Yes | Only 1 Referenced Study Sequence is mapped into the image. |
| Referenced SOP Class UID | (0008,1150) | O | 1C | Yes/Yes | |
| Referenced SOP Instance UID | (0008,1155) | O | 1C | Yes/Yes | |
| Requested Procedure Priority | (0040,1003) | O | 2 | No/No | |
| Patient Transport Arrangements | (0040,1004) | O | 2 | No/No | |
| Requested Procedure Location | (0040,1005) | O | 3 | No/No | |
| Confidentiality Code | (0040,1008) | O | 3 | No/No | |

6.1.6.4 Imaging Service Request Entity

6.1.6.4.1 Imaging Service Request Module

Table 6.1.6.4.1-1 – Imaging Service Request Module Attributes

| Attribute Name | Tag | Expected Matching Key Type | Expected Returned Key Type | Mapped into the Image/MPPS | Note |
|----------------|-----|----------------------------|----------------------------|----------------------------|------|
|----------------|-----|----------------------------|----------------------------|----------------------------|------|

| | | | | | |
|----------------------------|-------------|---|---|---------|--|
| Accession Number | (0008,0050) | O | 2 | Yes/Yes | User will be able to enter value for Accession Number prior to query to be sent as part of C-FIND request. Supports maximum of 16 characters. |
| Requesting Physician | (0032,1032) | O | 2 | No/No | |
| Referring Physician's Name | (0008,0090) | O | 2 | Yes/Yes | Truncated to 32 characters by default however this is configurable to allow 64 characters. |
| Requesting Service | (0032,1033) | O | 3 | No/No | |

6.1.6.5 Visit Entity

6.1.6.5.1 Visit Identification

Table 6.1.6.5.1-1 – Visit Identification Module Attributes

| Attribute Name | Tag | Expected Matching Key Type | Expected Returned Key Type | Mapped into the Image/MPPS | Note |
|------------------|-------------|----------------------------|----------------------------|----------------------------|------|
| Admission ID | (0038,0010) | O | 2 | No/No | |
| Institution Name | (0008,0080) | O | 3 | No/No | |

6.1.6.5.2 Visit Status

Table 6.1.6.5.2-1 – Visit Status Module Attributes

| Attribute Name | Tag | Expected Matching Key Type | Expected Returned Key Type | Mapped into the Image/MPPS | Note |
|--------------------------|-------------|----------------------------|----------------------------|----------------------------|-------------------------------------|
| Current Patient Location | (0038,0300) | O | 2 | No/No | Displayed on “More Info...” screen. |

6.1.6.5.3 Visit Relationship

Table 6.1.6.5.3-1 – Relationship Module Attributes

| Attribute Name | Tag | Expected Matching Key Type | Expected Returned Key Type | Mapped into the Image/MPPS | Note |
|-----------------------------|-------------|----------------------------|----------------------------|----------------------------|------|
| Referenced Patient Sequence | (0008,1120) | O | 2 | Yes/No | |
| Referenced SOP Class UID | (0008,1150) | O | 2 | Yes/No | |
| Referenced SOP Instance UID | (0008,1155) | O | 2 | Yes/No | |

6.1.6.5.4 Visit Admission

No data elements are requested from the Visit Admission Module.

6.1.6.6 Patient Entity

6.1.6.6.1 Patient Relationship

No data elements are requested from the Patient Relationship Module.

6.1.6.6.2 Patient Identification

Table 6.1.6.6.2-1 – Patient Identification Module Attributes

| Attribute Name | Tag | Expected Matching Key Type | Expected Returned Key Type | Mapped into the Image/MPPS | Note |
|------------------|--------------|----------------------------|----------------------------|----------------------------|--|
| Patient's Name | (0010,0010) | R | 1 | Yes/Yes | Supports up to 32 characters by default however this is configurable to allow 64 characters. See also Note1 . |
| Patient ID | (0010,0020) | R | 1 | Yes/Yes | Supports up to 16 characters by default however this is configurable to 64 characters. |
| Other Patient ID | (0010, 1000) | O | 3 | Yes/No | Supports 64 characters. |

Note 1 :

- Modality Worklist server supports 32 characters for patient Name
- Supports DICOM format for patient Name (with “^” as delimiters)
- If patient name in worklist has more than 32 characters then
 - Worklist will be accepted by the server
 - Worklist Browser will display only the first 32 characters
 - “More Info” screen will display the full patient name

- **Only the FIRST 32 characters is copied into the final DICOM image header by default however this is configurable to allow 64 characters.**

6.1.6.6.3 Patient Demographic

Table 6.1.6.6.3-1 – Patient Demographic Module Attributes

| Attribute Name | Tag | Expected Matching Key Type | Expected Returned Key Type | Mapped into the Image/ MPPS | Note |
|--|-------------|----------------------------|----------------------------|-----------------------------|---|
| Patient's Birth Date | (0010,0030) | O | 2 | Yes/Yes | This value is also used to calculate the Patient's Age. |
| Patient's Sex | (0010,0040) | O | 2 | Yes/Yes | |
| Patient's Weight | (0010,1030) | O | 2 | Yes/No | Limited to maximum value of 999 kg. |
| Confidentiality constraint on patient data | (0040,3001) | O | 2 | No/No | |
| Patient's Size | (0010,1020) | O | 3 | No/No | |
| Patient's Address | (0010,1040) | O | 3 | No/No | |
| Patient's Telephone Numbers | (0010,2154) | O | 3 | No/No | |

6.1.6.6.4 Patient Medical

Table 6.1.6.6.4-1 – Patient Medical Module Attributes

| Attribute Name | Tag | Expected Matching Key Type | Expected Returned Key Type | Mapped into the Image/ MPPS | Note |
|----------------------------|-------------|----------------------------|----------------------------|-----------------------------|-------------------------------------|
| Patient State | (0038,0500) | O | 2 | No/No | |
| Pregnancy Status | (0010,21C0) | O | 2 | No/No | Displayed on "More Info..." screen. |
| Medical Alerts | (0010,2000) | O | 2 | No/No | Displayed on "More Info..." screen. |
| Contrast Allergies | (0010,2110) | O | 2 | No/No | Displayed on "More Info..." screen. |
| Special Needs | (0038,0050) | O | 2 | No/No | Displayed on "More Info..." screen. |
| Additional Patient History | (0010,21B0) | O | 3 | Yes/No | Displayed on "More Info..." screen. |

6.2 Private Data Dictionary

The ModalityWorklist implementation does not define any Private Attributes within the Modality Worklist Information Model.

6.3 C-FIND Request Message

This section provides a detailed description of the C-FIND request message data that is provided to the remote AE during a worklist query operation. The dump in Table 6.4-1 below lists, in exact message order, the fields transferred as part of the C-FIND request message for a typical query.

In this particular dump, no values are specified for the Scheduled Procedure Step Start and End Dates (the attributes are sent with zero length). In DICOM this is interpreted as meaning all dates (i.e. universal matching). The Modality is also not specified in this particular dump, meaning all modalities. Note that the user, through the use of the GEHC CT user interface, can submit a worklist query that will cause non-zero values to be sent for these attributes.

Table 6.3-1 – C-FIND Request Message Dump

```
(0008,0000) UL 108          # 4, 1 IdentifyingGroupLength
(0008,0005) CS [ISO_IR 100] # 12, 1 SpecificCharacterSet
(0008,0050) SH (no value available) # 0, 0 AccessionNumber
(0008,0080) LO (no value available) # 0, 0 InstitutionName
(0008,0090) PN (no value available) # 0, 0 ReferringPhysicianName
(0008,1110) SQ (Sequence with explicit Length #=1) # 24, 1 ReferencedStudySequence
(fffe,e000) na (Item with explicit Length #=2) # 16, 1 Item
  (0008,1150) UI (no value available) # 0, 0 ReferencedSOPClassUID
  (0008,1155) UI (no value available) # 0, 0 ReferencedSOPInstanceUID
(fffe,e00d) na (ItemDelimitationItem for re-encoding) # 0, 1 ItemDelimitationItem
(fffe,e0dd) na (SequenceDelimitationItem for re-enc.) # 0, 1 SequenceDelimitationItem
(0008,1120) SQ (Sequence with explicit Length #=1) # 24, 1 ReferencedPatientSequence
(fffe,e000) na (Item with explicit Length #=2) # 16, 1 Item
  (0008,1150) UI (no value available) # 0, 0 ReferencedSOPClassUID
  (0008,1155) UI (no value available) # 0, 0 ReferencedSOPInstanceUID
(fffe,e00d) na (ItemDelimitationItem for re-encoding) # 0, 1 ItemDelimitationItem
(fffe,e0dd) na (SequenceDelimitationItem for re-enc.) # 0, 1 SequenceDelimitationItem
(0010,0000) UL 96          # 4, 1 PatientGroupLength
(0010,0010) PN (no value available) # 0, 0 PatientName
(0010,0020) LO (no value available) # 0, 0 PatientID
(0010,0030) DA (no value available) # 0, 0 PatientBirthDate
(0010,0040) CS (no value available) # 0, 0 PatientSex
(0010,1000) LO (no value available) # 0, 0 Other Patient IDs
(0010,1020) DS (no value available) # 0, 0 PatientSize
(0010,1030) DS (no value available) # 0, 0 PatientWeight
(0010,1040) LO (no value available) # 0, 0 PatientAddress
(0010,2000) LO (no value available) # 0, 0 MedicalAlerts
(0010,2110) LO (no value available) # 0, 0 ContrastAllergies
(0010,2154) SH (no value available) # 0, 0 PatientTelephoneNumber
(0010,2160) SH (no value available) # 0, 0 Ethinc Group
(0010,21b0) LT (no value available) # 0, 1 AdditionalPatientHistory
(0010,21c0) US (no value available) # 0, 0 PregnancyStatus
(0010,4000) LT (no value available) # 0, 0 Patient Comments
(0020,0000) UL 8          # 4, 1 ImageGroupLength
(0020,000d) UI (no value available) # 0, 0 StudyInstanceUID
(0032,0000) UL 64          # 4, 1 StudyGroupLength
```

(0032,1032) PN (no value available) # 0, 0 RequestingPhysician
 (0032,1033) LO (no value available) # 0, 0 RequestingService
 (0032,1060) LO (no value available) # 0, 0 RequestedProcedureDescription
 (0032,1064) SQ (Sequence with explicit Length #=1) # 32, 1 RequestedProcedureCodeSequence
 (ffff,e000) na (Item with explicit Length #=3) # 24, 1 Item
 (0008,0100) SH (no value available) # 0, 0 CodeValue
 (0008,0102) SH (no value available) # 0, 0 CodingSchemeDesignator
 (0008,0104) LO (no value available) # 0, 0 CodeMeaning
 (ffff,e00d) na (ItemDelimitationItem for re-encoding) # 0, 1 ItemDelimitationItem
 (ffff,e0dd) na (SequenceDelimitationItem for re-enc.) # 0, 1 SequenceDelimitationItem
 (0038,0000) UL 32 # 4, 1 VisitGroupLength
 (0038,0010) LO (no value available) # 0, 0 AdmissionID
 (0038,0050) LO (no value available) # 0, 0 SpecialNeeds
 (0038,0300) LO (no value available) # 0, 0 CurrentPatientLocation
 (0038,0500) LO (no value available) # 0, 0 PatientState
 (0040,0000) UL 192 # 4, 1 ModalityWorklistGroupLength
 (0040,0100) SQ (Sequence with explicit Length #=1) # 136, 1 ScheduledProcedureStepSequence
 (ffff,e000) na (Item with explicit Length #=12) # 128, 1 Item
 (0008,0060) CS (no value available) # 0, 0 Modality
 (0032,1070) LO (no value available) # 0, 0 RequestedContrastAgent
 (0040,0001) AE (no value available) # 0, 0 ScheduledStationAETitle
 (0040,0002) DA (no value available) # 0, 0 ScheduledProcedureStepStartDate
 (0040,0003) TM (no value available) # 0, 0 ScheduledProcedureStepStartTime
 (0040,0006) PN (no value available) # 0, 0 ScheduledPerformingPhysiciansName
 (0040,0007) LO (no value available) # 0, 0 ScheduledProcedureStepDescription
 (0040,0008) SQ (Seq with explicit Length #=1) # 32, 1 ScheduledActionItemCodeSequence
 (ffff,e000) na (Item with explicit Length #=3) # 24, 1 Item
 (0008,0100) SH (no value available) # 0, 0 CodeValue
 (0008,0102) SH (no value available) # 0, 0 CodingSchemeDesignator
 (0008,0104) LO (no value available) # 0, 0 CodeMeaning
 (ffff,e00d) na (ItemDelimitationItem for re-encoding) # 0, 1 ItemDelimitationItem
 (ffff,e0dd) na (SequenceDelimitationItem for re-enc.) # 0, 1 SequenceDelimitationItem
 (0040,0009) SH (no value available) # 0, 0 ScheduledProcedureStepID
 (0040,0010) SH (no value available) # 0, 0 ScheduledStationName
 (0040,0011) SH (no value available) # 0, 0 ScheduledProcedureStepLocation
 (0040,0012) LO (no value available) # 0, 0 PreMedication
 (ffff,e00d) na (ItemDelimitationItem for re-encoding) # 0, 1 ItemDelimitationItem
 (ffff,e0dd) na (SequenceDelimitationItem for re-enc.) # 0, 1 SequenceDelimitationItem
 (0040,1001) SH (no value available) # 0, 0 RequestedProcedureID
 (0040,1003) SH (no value available) # 0, 0 RequestedProcedurePriority
 (0040,1004) LO (no value available) # 0, 0 PatientTransportArrangements
 (0040,1005) LO (no value available) # 0, 0 RequestedProcedureLocation
 (0040,1008) LO (no value available) # 0, 0 ConfidentialityCode
 (0040,1010) PN (no value available) # 0, 0 Names of Intended Recipients
 (0040,1400) LT (no value available) # 0, 0 Requested Procedure Comments
 (0040,2400) LT (no value available) # 0, 0 Imaging Service Request Comm.
 (0040,3001) LO (no value available) # 0, 0 ConfidentialityConstraintOnPatientData

If the query is for a particular date range, the ScheduledProcedureStepStartDate will be filled with a valid date range. If either the start or end date are left blank by the user, they will simply be blank in the query.

Below is an example of a date range for August 30, 1997 through October 12, 1997.

(0040,0002) DA [19970830-19971012] # 18, 1 ScheduledProcedureStepStartDate

Below is an example of a date range for August 30, 1997 through the end of time.

(0040,0002) DA [19970830-] # 18, 1 ScheduledProcedureStepStartDate

Below is an example of a date range from the beginning of time through August 30, 1997.

(0040,0002) DA [-19970830] # 18, 1 ScheduledProcedureStepStartDate

If the query is for records for this modality, the Modality will be filled in as follows:

(0008,0060) CS [CT] # 2, 1 Modality

If the query is for records for this Scanner, the Modality will be filled in with CT as above and the Scheduled Station AE Title will be filled in with the value configured for this system. For example, this station was configured as CTRoom1.

(0040,0001) AE [CTRoom1] # 8, 1 ScheduledStationAETitle

User will be able to enter the values for “Accession Number” prior to the query. If value is entered then that value will be sent as part of the query. For example, if “1234” is entered then

(0008,0050) SH [1234] # 4, 1 AccessionNumber

User will be able to enter the values for “Requested Procedure Id” prior to the query. If value is entered then that value will be sent as part of the query. For example, if “3456” is entered then

(0040,1001) SH [3456] # 4, 1 RequestedProcedureID

User will be able to enter the values for “Patient Id” prior to the query. If value is entered then that value will be sent as part of the query. For example, if “6789” is entered then

(0010,0020) LO [6789] # 4, 1 PatientID

User will be able to enter the values for “Patient Name” prior to the query. If value is entered then that value will be sent as part of the query. For example, if “Lastname^Firstname” is entered then

(0010,0010) PN [Lastname^Firstname] # 18, 1 PatientName

6.4 Use of Specific DICOM Data

This section details the use of the DICOM data returned by remote AEs during worklist queries. The GEHC CT user interface fields that display the data, along with the data’s mapping into resulting acquired and transferred DICOM images, are presented in following table 6.5-1.

Table 6.4-1 – Specific Data Usage

| DICOM Worklist Data Element | Patient Schedule Screen Field | GEHC CT DICOM Image Data Element |
|-----------------------------|-------------------------------|----------------------------------|
|-----------------------------|-------------------------------|----------------------------------|

| | | |
|---|--|--|
| Accession Number (0008,0050) | Req Number | Accession Number Supports maximum of 16 characters. Can be configured so the top level accession number tag in the image header will be empty if worklists are grouped and have different accession numbers. Default behavior is to fill in the top level accession number in the grouped case. |
| Patient ID (0010,0020) | Patient ID | Patient ID Supports maximum of 16 characters. Can be configured to allow 64 characters. |
| Other Patient ID (0010,1000) | Other Patient Ids (only displayed on the More Info screen) | Patient ID Supports maximum of 64 characters. |
| Patient Name (0010,0010) | Patient Name | Patient Name Supports maximum of 32 characters. Can be configured to allow 64 characters. |
| Patient's Birth Date (0010,0030) | Patient Age (Patient Birth Date user to calculate age) | Patient Birth Date |
| Patient's Sex (0010,0040) | Sex | Patient's Sex |
| Patient's Weight (0010,1030) | Weight in Kg | Patient's Weight |
| Referring Physician's Name (0008,0090) | Referring Physician | Referring Physician's Name |
| Requested Procedure Description (0032,1060) | Exam Description | Study Description. |
| Scheduled Procedure Step Start Date (0040,0002) | Date | Not available. |
| Scheduled Procedure Step Start Time (0040,0003) | Time | Not available. |
| Scheduled Performing Physician's Name (0040,0006) | Performing Physician (only displayed on the "More Info..." screen) | This value is mapped into (0008, 1050) in the image header. |
| Study Instance UID (0020,000d) | Study instance UID (only displayed on the "More Info..." screen) | Study Instance UID, if User has set the preference to "Use MWL Study UID". |
| Requested Procedure Id (0040,1001) | Requested Proc ID | Requested Procedure Id. |
| Pregnancy Status (0010,21C0) | Pregnancy Status (only displayed on the "More Info..." screen) | Not available. |
| Medical Alerts (0010,2000) | Medical Alerts (only displayed on the "More Info..." screen) | Not available. |

| | | |
|--|--|------------------|
| Contrast Allergies (0010,2110) | Contrast Allergies (only displayed on the “More Info...” screen) | Not available. |
| Special Needs (0038,0050) | Special Needs (only displayed on the “More Info...” screen) | Not available. |
| Requested Contrast Agent (0032,1070) | Requested Contrast Agent (only displayed on the “More Info...” screen) | Not available. |
| Current Patient Location (0038,0300) | Current Patient Location (only displayed on the “More Info...” screen) | Not available. |
| Additional Patient History (0010,21B0) | Additional Patient History (only displayed on the “More Info...” screen) | Patient History. |

Note that the display of a specific data item on the “More Info...” screen is contingent on the item being enabled for display. Depending on the preferences of each specific site, data can either be displayed or not. A GE field service engineer can assist in setting these site preferences.

6.5 Setting User Preferences

6.5.1 Setting “Use MWL Study UID “ Option

Setting this option to “**Yes**” copies the **Study Instance UID** from Worklist into the final **DICOM Image header**. If this option is set to “**No**” then a new study instance uid will be generated locally.

1. Click on “Patient Schedule”
2. Click on “Preferences” button
3. Set the option “Use Study UID?”, to either “Yes” or “No”

6.5.2 Setting Custom Query Option

This option allows the user to enter values for “Accession Number” and / or “ Requested Procedure Id” , which are used for Custom Query.

1. Click on “Patient Schedule”
2. Click on “Preferences” button
3. Set the option “**Show Update Parameters?** ”, to “**Yes**”

4. To do a query click on “Update” button.
A User Interface appears, with provision to enter values for:
 - a) Accession Number
 - b) Requested Proc. ID

7 Modality Performed Procedure Step Implementation

7.1 Introduction

This section of the DICOM Conformance Statement specifies the compliance to DICOM conformance requirements for the Modality Performed Procedure Step feature on this GEHC product. Note that the format of this section strictly follows the format defined in DICOM Standard PS 3.2 (Conformance). Please refer to that part of the standard while reading this section. The PPS option for GEHC CT allows a Modality Performed Procedure Step to be communicated to the Hospital/Radiology information system. The PPS feature is providing the DICOM Modality Performed Procedure Step service as a service class user (SCU).

This feature works in conjunction with DICOM Modality Worklist feature, if installed. However the conformance of this feature is independent of Modality Worklist feature. For information on conformance of Modality Worklist feature to DICOM standard please refer to the appropriate section or document.

7.2 N-CREATE & N-SET Request Message

PPS Feature for GEHC CT supports all named attributes listed in Table F.7.2.1 in PS3.4 of DICOM standard. That is, attributes that are not explicitly referenced by name in the table are not supported. (Example is last row in the table reads "All other attributes from Radiation Dose Module and Billing and Material Code Module". The attributes referenced here are not supported).

For the MPPS associated with an acquisition, the following attributes are copied from the Modality Worklist SCU into the MPPS request Message, if procedure performed corresponds to the SPS information retrieved through the Modality Worklist.

GEHC CT supports the selection of single or multiple SPS for a scan. The following are applicable.

- Single SPS selection results in single PPS message
- Multiple SPS selection results in single PPS message
- Multiple SPS selection is allowed **only if they all correspond to same patient id**
- A maximum of 15 SPS's can be selected
- Referenced Study Sequence - a maximum of ten Item's is supported. *This attribute will be present only if SPS information is available from Modality Worklist SCU.*
- At the end of acquisition the user might choose to 'Defer PPS' and later choose to 'Complete PPS' or 'Discontinue PPS' from the user interface provided in the system.

In this case, the date and time when user chooses to 'Complete PPS' or 'Discontinue PPS' is taken as the Performed Procedure Step End Date and Performed Procedure Step End Time respectively (Not the actual end date and end time of acquisition)

- Mapping of SPS data to **MPPS SOP instance** is explained in section 7.3
- Mapping of specific SPS data to **CT DICOM IMAGE HEADER** , for PPS is explained in section 7.4

For the MPPS associated with a post-processing the following restrictions apply on the attributes listed below.

- Referenced Study Sequence – The sequence is not sent in the MPPS message
- Scheduled Step Attribute Sequence – a maximum of ONE item is supported. The attribute will be send only if SPS information is available in the image instance.
- Referenced Patient Sequence – This sequence is not added
- Scheduled Protocol Code Sequence – The sequence is not send in the MPPS message
- Performed Procedure Step Start date & Performed Procedure Step start time – The exam date and exam time that is the Start date and Start Time of the associated Study Component (Exam) is used, not the actual time when post-processing started.
- Performed Procedure Step end date & Performed Procedure Step end time - The date and time when user chooses to 'Complete PPS' or 'Discontinue PPS' is taken as the Performed Procedure Step End Date and Performed Procedure Step End Time respectively (Not the actual end date and end time of post-processing).
- Procedure Code Sequence – This sequence is sent with ZERO items in the MPPS message
- Performed Protocol Code Sequence – This sequence is sent with ZERO items in the MPPS message.
- Referenced Standalone SOP Instance Sequence – The sequence is sent with ZERO items in the MPPS message.

7.3 MODALITY PERFORMED PROCEDURE STEP MODULE DEFINITIONS

The following table gives specific usage of some of attributes in the MPPS SOP instance created, with reference to each of the real-world scenarios mentioned in 2.3.1.2.7.1.1 of this document.

| Attribute Name | Tag | Usage in MPPS Instance | | |
|--|-------------|---|----------------------------------|--|
| | | Acquisition with MWL data | Acquisition without MWL data | Post-Processing |
| Specific Character Set | (0008,0005) | Not used, but copied into image header | Not used | Not used, but copied into image header |
| Scheduled Step Attribute Sequence | (0040,0270) | Up to 15 items | | Up to 15 items |
| >Study Instance UID | (0020,000D) | Copied from SPS, if option to copy is selected or else created at the scanner | Created at the scanner | Copied from source image |
| >Referenced Study Sequence | (0008,1110) | Copied from SPS, if selected | Not sent as part of image header | Not sent as part of image header |
| >Accession Number | (0008,0050) | Copied from SPS, if selected | User input on the scanner | Copied from source image |
| >Placer Order Number/Imaging Service Request | (0040,2016) | Not sent as part of image header | Not sent as part of image header | Not sent as part of image header |
| >Filler Order Number/Imaging Service Request | (0040,2017) | Not sent as part of image header | Not sent as part of image header | Not sent as part of image header |
| >Requested Procedure ID | (0040,1001) | Copied from SPS, if selected | User input on the scanner | Copied from source image |
| >Requested Procedure Description | (0032,1060) | Copied from SPS, if selected | Not used | Not sent as part of image header |
| >Placer Order Number/Procedure | (0040,1006) | Not sent as part of image header | Not used | Not sent as part of image header |
| >Filler Order Number/Procedure | (0040,1007) | Not sent as part of image header | Not used | Not sent as part of image header |
| >Scheduled Procedure ID | (0040,0009) | Copied from SPS, if selected | Not used | Copied from source image |
| > Scheduled Performing Physician's Name | (0040,0006) | Not sent | Not sent | Not sent |
| >Scheduled Procedure Step Description | (0040,0007) | Copied from SPS, if selected | Not used | Copied from source image |
| >Scheduled Protocol Code Sequence | (0040,0008) | Copied from SPS, if selected | Not used | Not sent as part of image header |
| Patient's Name | (0010,0010) | Copied from SPS, if selected | User input on the scanner | Copied from source image |

| Attribute Name | Tag | Usage in MPPS Instance | | |
|--------------------------------------|-------------|---|---|--|
| | | Acquisition with MWL data | Acquisition without MWL data | Post-Processing |
| Patient ID | (0010,0020) | Copied from SPS, if selected | User input on the scanner | Copied from source image |
| Patient's Birth Date | (0010,0030) | Copied from SPS, if selected | User input on the scanner | Copied from source image |
| Patient's Sex | (0010,0040) | Copied from SPS, if selected | User input on the scanner | Copied from source image |
| Referenced Patient Sequence | (0008,1120) | Sent empty, zero length | Sent empty, zero length | Sent empty, zero length |
| Performed Procedure Step ID | (0040,0253) | Created at the scanner. Will have the following "PPS_ID_<exam number" | Created at the scanner. Will have the following "PPS_ID_<exam number" | New generated, may not be unique |
| Performed Station AE Title | (0040,0241) | Local system host-name | Local system host-name | Local system host-name |
| Performed Station Name | (0040,0242) | Sent empty, zero length | Sent empty, zero length | Sent empty, zero length |
| Performed Location | (0040,0243) | Sent empty, zero length | Sent empty, zero length | Sent empty, zero length |
| Performed Procedure Step Start Date | (0040,0244) | Same as exam start date | Same as exam date | Same as exam date |
| Performed Procedure Step Start Time | (0040,0245) | Same as exam start time | Same as exam time | Same as exam time |
| Performed Procedure Step Description | (0040,0254) | Copied from SPS, if selected | Not sent as part of image header | Not sent as part of image header |
| Performed Procedure Step status | (0040,0252) | See Note 1. | See Note 1. | See Note 1. |
| Performed Procedure Type Description | (0040,0255) | Not sent as part of image header | Not sent as part of image header | Not sent as part of image header |
| Procedure Code Sequence | (0008,1032) | Not sent as part of image header. Not sent in MPPS N-Create. | Not sent as part of image header. Not sent in MPPS N-Create. | Not sent as part of image header. Not sent in MPPS N-Create. |
| Performed Procedure Step End Date | (0040,0250) | Date when all images got installed | Date when all images got installed | The date "Complete PPS" or "Discontinue PPS" is invoked, not the actual end of post-processing |
| Performed Procedure Step End Time | (0040,0251) | Time when all images got installed | Time when all images got installed | The time "Complete PPS" or "Discontinue PPS" is invoked, not the |

| Attribute Name | Tag | Usage in MPPS Instance | | |
|--|-------------|---|---|---|
| | | Acquisition with MWL data | Acquisition without MWL data | Post-Processing |
| | | | | actual end of post-processing |
| Performed Procedure Step Discontinuation Reason Code Sequence | (0040,0281) | The reason of the Performed Procedure Step Status(0040,0252) was set to "DISCONTINUED". | | |
| >Code Value | (0008,0100) | Sent as "110513" | | |
| >Coding Scheme Designator | (0008,0102) | Sent as "DCM" | | |
| >Code Meaning | (0008,0104) | Sent as "Discontinued for unspecified reason" | | |
| Modality | (0008,0060) | Value "CT" is stored in image header | Value "CT" is stored in image header | Value "CT" is stored in image header |
| Study ID | (0020,0010) | Same as exam number | Same as exam number | Copied from source image |
| Performed Protocol Code Sequence | (0040,0260) | Derived from (0040, 0008) | Not used | Not used |
| Performed Series Sequence | (0040,0340) | One item for each series created | One item for each series created | One item for each series created with post-processing |
| >Performing Physician's Name | (0008,1050) | Copied from SPS, if selected | User input on the scanner | Copied from source image |
| >Protocol Name | (0018,1030) | The name of the protocol selected on the scanner | The name of the protocol selected on the scanner | Copied from source image |
| >Operator's Name | (0008,1070) | Copied from SPS if selected and present otherwise from user input on the scanner | User input on the scanner | Not sent as part of image header |
| >Retrieve AE Title | (0008,0054) | Sent empty, zero length | Sent empty, zero length | Sent empty, zero length |
| >Referenced Image Sequence | (0008,1140) | One item for each image created within the series | One item for each image created within the series | One item for each image generated by post-processing |
| > Referenced Non-Image Composite SOP Instance Sequence | (0040,0220) | One item for each GSPS or Dose SR created within the series | One item for each GSPS or Dose SR created within the series | One item for each GSPS or Dose SR created within the series |
| >All other attributes from Performed Series Sequence (which Table F.7.2.1 of | | Not sent as part of image header | Not sent as part of image header | Not sent as part of image header |

| Attribute Name | Tag | Usage in MPPS Instance | | |
|---|-----|----------------------------------|----------------------------------|----------------------------------|
| | | Acquisition with MWL data | Acquisition without MWL data | Post-Processing |
| DICOM standard PS3.4 does not explicitly list) | | | | |
| All other attributes from Radiation Dose Module and Billing and Material Code Module (which Table F.7.2.1 of DICOM standard PS3.4 does not explicitly list) | | Not sent as part of image header | Not sent as part of image header | Not sent as part of image header |

- Note 1:**
- When PPS start (N-CREATE) message is sent, this element will have the value “IN PROGRESS”
 - When PPS end (N-SET) message is sent, this element will have either “COMPLETED” or “DISCONTINUED” based on user selection

7.4 Use of Specific DICOM Data

7.4.1 Patient Level

| Attribute Name | Tag | Usage in CT DICOM Image Header |
|-----------------------------|-------------|--------------------------------|
| Patient Name | (0010,0010) | Copied from SPS, if selected |
| Patient ID | (0010,0020) | Copied from SPS, if selected |
| Patient Birthdate | (0010,0030) | Copied from SPS, if selected |
| Patient Sex | (0010,0040) | Copied from SPS, if selected |
| Referenced Patient Sequence | (0008,1120) | Copied from SPS, if selected |
| Ref. SOP class uid | (0008,1150) | |
| Ref. SOP Instance uid | (0008,1155) | |

7.4.2 Study Level

| Attribute Name | Tag | Usage in CT DICOM Image Header |
|---------------------------|-------------|--|
| Study Instance UID | (0020,000D) | Copied from SPS, if selected |
| Study ID | (0020,0010) | Scanner generated study ID |
| Referring Physicians name | (0008,0090) | Copied from SPS, if selected |
| Accession Number | (0008,0050) | If multiple SPS’s are selected, then accession number from the first selection (determined by the user) is used, however, it is configurable to be set to zero |

| Attribute Name | Tag | Usage in CT DICOM Image Header |
|---------------------------|-------------|--|
| | | length. Default is to use the accession number from the first selection. |
| Referenced Study Sequence | (0008,1110) | Copied from SPS, if selected |
| Ref. SOP class uid | (0008,1150) | |
| Ref. SOP Instance uid | (0008,1155) | |

7.4.3 Series Level

| Attribute Name | Tag | Usage in CT DICOM Image Header |
|--|-------------|---|
| Modality | (0008,0060) | Value "CT" is copied |
| Protocol Name | (0018,1030) | Name of the selected protocol is copied |
| Operator Name | (0008,1070) | Copied from SPS if selected and present otherwise generated from user input on scanner |
| Referenced Performed Procedure Step Sequence | (0008,1111) | |
| Ref. SOP class uid | (0008,1150) | Value of MPPS SOP class UID |
| Ref. SOP Instance uid | (0008,1155) | Scanner generated unique UID |
| Requested Attribute Sequence | (0040,0275) | Will be present only if SPS obtained from HIS/RIS is selected for scanning. If multiple SPS's are selected then this will contain multiple items one for each SPS. For all other cases this element will not be present |
| Requested Procedure Id | (0040,1001) | Copied from SPS, if selected |
| Scheduled Procedure Step Id | (0040,0009) | Copied from SPS, if selected |
| Scheduled Procedure Step description | (0040,0007) | Copied from SPS, if selected |
| Scheduled Protocol Code Sequence | (0040,0008) | Copied from SPS, if selected |
| Performed Procedure Step Id | (0040,0253) | Created at the scanner. The string " PPS_ID_<exam number> " is used. |
| Performed Procedure Step start date | (0040,0244) | Same as exam start date |
| Performed Procedure Step start time | (0040,0245) | Same as exam start time |
| Performed Procedure Step description | (0040,0254) | Exam description is used |

8 Grayscale Softcopy Presentation State Implementation

8.1 Introduction

This section specifies the use of the DICOM Grayscale Softcopy Presentation State (GSPS) IOD to represent the information included in GSPSs produced by this product.

8.2 CT Mapping of DICOM Entities

The CT system maps DICOM Information Entities to local Information Entities in the product's database and user interface.

| DICOM IE | CT Entity |
|--------------------|--------------------|
| Patient | Patient |
| Study | Exam |
| Series | Series |
| Presentation State | Presentation State |

8.3 IOD Module Table

The Grayscale Softcopy Presentation State Information Object Definition comprises the modules of the following table.

| Entity Name | Module Name | Reference | Usage |
|--------------------|-----------------------------------|---|-------|
| Patient | Patient | 8.4.1.1 | M |
| Study | General Study | 8.4.2.1 | M |
| | Patient Study | 8.4.2.2 | U |
| Series | General Series | 8.4.3.1 | M |
| | Presentation Series | 8.4.3.2 | M |
| Equipment | General Equipment | 8.4.4.1 | M |
| Presentation State | Presentation State Identification | 8.4.5.1 | M |
| | Presentation State Relationship | 8.4.5.2 | M |
| | Presentation State Shutter | Exam Split : Not sent (attribute condition not met) Save State : 8.4.5.3 | M |
| | Presentation State Mask | Not sent (attribute condition not met) | M |
| | Mask | Not sent (no multi-frame present) | C |
| | Display Shutter | Not sent (no display shutter) | C |

| | | | |
|--|---------------------------|---|---|
| | Bitmap Display Shutter | Not sent (no bitmap data present) | C |
| | Overlay Plane | Not sent (no overlay data present) | C |
| | Overlay Activation | Not sent (no overlay data present) | C |
| | Displayed Area | 8.4.5.4 | M |
| | Graphic Annotation | Not sent (no annotation data present) | C |
| | Spatial Transformation | Not sent (no flip/rotate being applied) | C |
| | Graphic Layer | Not sent (no graphics layers are added) | C |
| | Modality LUT | 8.4.5.5 | C |
| | Softcopy VOI LUT | 8.4.5.6 | C |
| | Softcopy Presentation LUT | 8.4.5.7 | M |
| | SOP Common | 8.4.5.8 | M |

8.4 Information Module Definitions

Please refer to DICOM Part 3 (Information Object Definitions) for a description of each of the entities, modules, and attributes contained within the GSPS Information Object. The following modules are included to convey Enumerated Values, Defined Terms, and Optional Attributes supported. Type 1 & Type 2 Attributes are also included for completeness and to define what values they may take and where these values are obtained from when generating the instance. It should be noted that they are the same ones as defined in the DICOM Standard Part 3 (Information Object Definitions). Also note that Attributes not present in tables are not supported

8.4.1 Patient Entity Module

8.4.1.1 Patient Module

| Attribute Name | Tag | Type | Notes |
|----------------------|-------------|------|-----------------------------|
| Patient's Name | (0010,0010) | 2 | Copied from original images |
| Patient ID | (0010,0020) | 2 | Copied from original images |
| Patient's Birth Date | (0010,0030) | 2 | Copied from original images |
| Patient's Sex | (0010,0040) | 2 | Copied from original images |
| Other Patient ID | (0010,1000) | 3 | Copied from original images |

8.4.2 Study Entity Module

8.4.2.1 General Study Module

| Attribute Name | Tag | Type | Notes |
|-------------------------------|-------------|------|--|
| Study Instance UID | (0020,000D) | 1 | Copied from original images |
| Study Date | (0008,0020) | 2 | Copied from original images |
| Study Time | (0008,0030) | 2 | Copied from original images |
| Accession Number | (0008,0050) | 2 | Copied from original images |
| Referring Physician's Name | (0008,0090) | 2 | Copied from original images |
| Referenced Study Sequence | (0008,1110) | 3 | Exam Split : Copied from original images Save State : Not sent |
| > Referenced SOP Class UID | (0008,1150) | 1 | Value copied from original Images corresponding to the Requested Procedure this GSPS is responding to. |
| > Referenced SOP Instance UID | (0008,1155) | 1 | Value copied from original Images corresponding to the Requested Procedure this GSPS is responding to |
| Study ID | (0020,0010) | 2 | Copied from original images |
| Study Description | (0008,1030) | 3 | Exam Split : Copied from original images Save State : Not Sent |

Note: *If two or more of the accession numbers in the grouped case are different, the top level Accession Number (0008, 0050) shall contain 1 of the accession numbers if the relevant CT Image Objects contain a value in the top level Accession Number (0008, 0050) otherwise the top level Accession Number shall be zero length.*

8.4.2.2 Patient Study Module

| Attribute Name | Tag | Type | Notes |
|------------------------------|-------------|------|-----------------------------|
| Patient's Age | (0010,1010) | 3 | Copied from original images |
| Patient's Size | (0010,1020) | 3 | Copied from original images |
| Patient's Weight | (0010,1030) | 3 | Copied from original images |
| Additional Patient's History | (0010,21b0) | 3 | Not Sent. |

8.4.3 Series Entity Module

8.4.3.1 General Series Module

| Attribute Name | Tag | Type | Notes |
|----------------|-------------|------|---|
| Series Number | (0020,0011) | 2 | Set to(original Series Number + 100000) |

| | | | |
|--------------------------------------|-------------|----|--|
| Laterality | (0020,0060) | 2C | Not Sent. |
| Series Date | (0008,0021) | 3 | Not Sent. |
| Series Time | (0008,0031) | 3 | Not Sent. |
| Modality | (0008,0060) | 1 | “PR” |
| Performing Physician’s Name | (0008,1050) | 3 | Not Sent. |
| Protocol Name | (0018,1030) | 3 | Not Sent. |
| Series Description | (0008,103E) | 3 | Exam Split : This will be set as Requested Procedure Code Meaning. If Code Meaning absent, it will be Requested Procedure Description Save State : “Presentation Series” |
| Operators Name | (0008,1070) | 3 | Not sent |
| Series Instance UID | (0020,000E) | 1 | Generated new number for each series and always sent. |
| Performed Procedure Step Start Date | (0040,0244) | 3 | Exam Split : Calculated and sent. Save State ; Not sent |
| Performed Procedure Step Start Time | (0040,0245) | 3 | Exam Split : Calculated and sent. Save State : Not sent. |
| Performed Procedure Step ID | (0040,0253) | 3 | Exam Split : Will be set as Requested Procedure ID (0040,1001) from (0040,0275) Save State : Not sent. |
| Performed Procedure Step Description | (0040,0254) | 3 | Exam Split : This will be set as Requested Procedure Code Meaning with a “PGP-” prefix. If Code Meaning absent, it will be Requested Procedure Description. The length will be truncated to 64 if necessary. Save State : Not sent. |
| Requested Attributes Sequence | (0040,0275) | 3 | Exam Split : Sent when MPPS option is enabled and filled in based on what RIS provides to scanner. Number of items relates to number of items selected from Patient Schedule. Save State : Not sent. |
| > Requested Procedure ID | (0040,1001) | 1C | Exam Split : Always sent, copied from RIS Save State : Not sent. |
| > Accession Number | (0008,0050) | 3 | Exam Split : Value from worklist sent Save State : Not sent. |
| > Referenced Study Sequence | (0008,1110) | 3 | Exam Split : Value from worklist sent Save State : Not sent. |

| | | | |
|--|-------------|----|--|
| > Study Instance UID | (0020,000D) | 3 | Exam Split : Value from worklist sent Save State : Not sent. |
| > Requested Procedure Desc | (0032,1060) | 3 | Exam Split : Value from worklist sent Save State : Not sent. |
| > Requested Procedure Code Sequence | (0032,1064) | 3 | Exam Split : Value from worklist sent. Save State : Not sent. |
| > Scheduled Procedure Step Desc | (0040,0007) | 3 | Exam Split : Value from worklist sent Save State : Not sent. |
| > Scheduled Protocol Code Sequence | (0040,0008) | 3 | Exam Split : Value from worklist sent Save State : Not sent. |
| > Scheduled Procedure Step ID | (0040,0009) | 3 | Exam Split : Value from worklist sent Save State : Not sent. |
| > Reason for Requested Procedure | (0040,1002) | 3 | Exam Split : Not sent. Save State : Not sent. |
| > Reason for Requested Procedure Code sequence | (0040,1004) | 3 | Exam Split : Not sent. Save State : Not sent. |
| Referenced Performed Procedure Step Sequence | (0008,1111) | 3 | Exam Split : Value used for performed procedure step Save State : Not Sent. |
| >Referenced SOP Class UID | (0008,1150) | 1C | Copied from original images |
| >Referenced SOP Instance UID | (0008,1155) | 1C | Generated for each series and always sent. |

Note: If scheduled procedures are grouped, the accession number for each procedure is stored in the Request Attributes Sequence (0040, 0275) in the image header.

8.4.3.2 Presentation Series Module

| Attribute Name | Tag | Type | Notes |
|----------------|-------------|------|-------|
| Modality | (0008,0060) | 1 | "PR" |

8.4.4 Equipment Module

8.4.4.1 General Equipment

| Attribute Name | Tag | Type | Notes |
|------------------|-------------|------|-------------------------------------|
| Manufacturer | (0008,0070) | 2 | Always sent as "GE MEDICAL SYSTEMS" |
| Institution Name | (0008,0080) | 3 | Copied from original images |

| Attribute Name | Tag | Type | Notes |
|--------------------------|-------------|------|-----------------------------|
| Station Name | (0008,1010) | 3 | Copied from original images |
| Manufacturers Model Name | (0008,1090) | 3 | Copied from original images |
| Software Versions | (0018,1020) | 3 | Copied from original images |

8.4.5 Presentation State Entity Module

8.4.5.1 Presentation State Identification Module

| Attribute Name | Tag | Type | Notes |
|----------------------------|-------------|------|--|
| Presentation Creation Date | (0070,0082) | 1 | Calculated and sent. |
| Presentation Creation Time | (0070,0083) | 1 | Calculated and sent. |
| Instance Number | (0020,0013) | 1 | Set to 23 and sent. |
| Content Label | (0070,0080) | 1 | Exam Split: This will be set as "PGP" plus Requested Procedure Code Meaning or Requested Procedure Description converted to all capital letters and truncated to 16 characters. Save State : "GEGSPS_0" |
| Content Description | (0070,0081) | 2 | Exam Split : String input on Comments box in Exam Split screen Save State : "SE (Series Number) IM (First Image Number) TO IM (Last Image Number)" |
| Content Creator's Name | (0070,0084) | 2 | Same as Station Name(0008,1010) |

8.4.5.2 Presentation State Relationship

| Attribute Name | Tag | Type | Notes |
|-------------------------------|-------------|------|--|
| Referenced Series Sequence | (0008,1115) | 1 | Calculated and sent. |
| > Referenced Image Sequence | (0008,1140) | 1 | Always sent, references images selected. |
| >> Reference SOP Class UID | (0008,1150) | 1 | Always sent |
| >> Reference SOP Instance UID | (0008,1155) | 1 | Always sent |

| | | | |
|-----------------------|-------------|---|---|
| > Series Instance UID | (0020,000E) | 1 | Always sent, references series selected |
|-----------------------|-------------|---|---|

8.4.5.3 Presentation State Shutter

| Attribute Name | Tag | Type | Notes |
|----------------------------|-------------|------|--|
| Shutter Presentation Value | (0018,1622) | 1C | Exam Split : Not sent. Save State : Not sent. |

8.4.5.4 Displayed Area

| Attribute Name | Tag | Type | Notes |
|--|-------------|------|--|
| Displayed Area Selection Sequence | (0070,005A) | 1 | Exam Split : calculated values for pan and zoom being displayed. Save State : the number of images in the original series |
| >Referenced Image Sequence | (0008,1140) | 1C | Always sent. |
| >Displayed Area Top Left Hand Corner | (0070,0052) | 1 | Always sent. |
| >Displayed Area Bottom Right Hand Corner | (0070,0053) | 1 | Always sent. |
| >Presentation Size Mode | (0070,0100) | 1 | Always sent. |
| >Presentation Pixel Spacing | (0070,0101) | 1C | Always sent. |
| >Presentation Pixel Magnification Ratio | (0070,0103) | 1C | Always sent. |

8.4.5.5 Modality LUT Module

| Attribute Name | Tag | Type | Notes |
|-------------------------|-------------|------|---------------------|
| Rescale slope intercept | (0028,1052) | 1C | Always sent |
| Rescale slope | (0028,1053) | 1C | Always sent |
| Rescale type | (0028,1054) | 1C | Always sent as "HU" |

8.4.5.6 Softcopy VOI LUT Module

| Attribute Name | Tag | Type | Notes |
|---------------------------|-------------|------|-------------|
| Softcopy VOI LUT Sequence | (0028,3110) | 1 | Always sent |

| | | | |
|--|-------------|----|-------------|
| > Reference Image Sequence | (0008,1140) | 1C | Always sent |
| > Window Center | (0028,1050) | 1C | Always sent |
| > Window Width | (0028,1051) | 1C | Always sent |
| > Window Center & Width Explanation | (0028,1055) | 3 | Always sent |

8.4.5.7 Softcopy Presentation LUT Module

| Attribute Name | Tag | Type | Notes |
|---------------------------|-------------|------|------------------------------|
| Presentation LUT sequence | (2050,0010) | 1C | Not sent, condition not met. |
| Presentation LUT shape | (2050,0020) | 1C | Always sent as "IDENTITY" |

8.4.5.8 SOP Common Module

| Attribute Name | Tag | Type | Notes |
|------------------------|-------------|------|---------------------|
| SOP Class UID | (0008,0016) | 1 | Always sent. |
| SOP Instance UID | (0008,0018) | 1 | Always sent. |
| Specific Character Set | (0008,0005) | 1C | "ISO_IR 100" |
| Instance Creation Date | (0008,0012) | 3 | Always sent. |
| Instance Creation Time | (0008,0013) | 3 | Always sent. |
| Instance Number | (0020,0013) | 1 | Set to 23 and sent. |

8.5 Image Header Changes Supporting GSPS

8.5.1 Request Attributes Sequence

The (0040, 0275) Request Attributes Sequence has been expanded to include dicom tags that the Virtual Exam Split (VES) application requires to complete the VES GSPS and PPS.

The Requested Attributes Sequence may contain a maximum of 15 sequence items. This sequence will only appear in the image header if the VES/HES option is installed or PPS is enabled..

8.5.2 Accession Number

If scheduled procedures are grouped, the accession number for each procedure is stored in the Request Attributes Sequence (0040, 0275) in the image header.

If two or more of the accession numbers in the grouped case are different, the top level Accession Number (0008, 0050) will be sent empty.

9 Structured Report Information Object Implementation

GEHC CT system supports 2 types of SRs, Enhanced SR and X-ray Radiation Dose SR. Both of them support following attributes.

9.1 IOD Module Table

| Entity Name | Module Name | Reference | Usage |
|-------------|----------------------------|-----------|-------|
| Patient | Patient | A.3.1 | M |
| Study | General Study | A.3.2 | M |
| | Patient Study | A.3.3 | U |
| Series | SR Document Series | 9.2 | M |
| Equipment | General Equipment | A.3.5 | M |
| | Enhanced General Equipment | A.3.9 | M |
| Document | SR Document General | 9.3 | M |
| | SR Document Content | 9.4 | M |
| | SOP Common | A.3.8 | M |

9.2 SR Document Series Module

| Attribute Name | Tag | Type | Notes |
|--|-------------|------|--------------------|
| Modality | (0008,0060) | 1 | Sent as "SR" |
| Series Instance UID | (0020,000E) | 1 | Sent. |
| Series Number | (0020,0011) | 1 | Sent as "997" |
| Referenced Performed Procedure Step Sequence | (0008,1111) | 2 | Sent with one item |

9.3 SR Document General Module

| Attribute Name | Tag | Type | Notes |
|---|-------------|------|--------------------------|
| Instance Number | (0020,0013) | 1 | Sent |
| Completion Flag | (0040,A491) | 1 | COMPLETE sent |
| Completion Flag Description | (0040,A492) | 3 | Sent empty |
| Verification Flag | (0040,A493) | 1 | UNVERIFIED sent |
| Content Date | (0008,0023) | 1 | Sent |
| Content Time | (0008,0033) | 1 | Sent |
| Verifying Observer Sequence | (0040,A073) | 1C | Not sent per conditional |
| >Verifying Observer Name | (0040,A075) | 1 | Not sent |
| >Verifying Observer Identification Code Sequence | (0040,A088) | 2 | Not sent |
| >>Include 'Code Sequence Macro' Table 8.8-1 | | | Not sent |
| >Verifying Organization | (0040,A027) | 1 | Not sent |
| >Verification DateTime | (0040,A030) | 1 | Not sent |
| Author Observer Sequence | (0040,A078) | 3 | Not sent |
| >Include 'Identified Person or Device Macro' Table C.17-3b | | | |
| Participant Sequence | (0040,A07A) | 3 | Not sent |
| >Participation Type | (0040,A080) | 1 | Not sent |
| >Participation DateTime | (0040,A082) | 2 | Not sent |
| >Include 'Identified Person or Device Macro' Table C.17-3b | | | |
| Custodial Organization Sequence | (0040,A07C) | 3 | Not sent |
| >Institution Name | (0008,0080) | 2 | Not sent |
| >Institution Code Sequence | (0008,0082) | 2 | Not sent |
| >>Include 'Code Sequence Macro' Table 8.8-1 | | | |
| Predecessor Documents Sequence | (0040,A360) | 1C | Not sent per condition |
| >Include 'Hierarchical SOP Instance Reference Macro' Table C.17-3 | | | |
| Identical Documents Sequence | (0040,A525) | 1C | Not sent per condition |
| >Include 'Hierarchical SOP Instance Reference Macro' Table C.17-3 | | | |
| Referenced Request Sequence | (0040,A370) | 1C | Not sent per condition |
| >Study Instance UID | (0020,000D) | 1 | Not Sent |
| >Referenced Study Sequence | (0008,1110) | 2 | Not Sent |
| >> Include 'SOP Instance Reference Macro' Table 10-11 | | | |
| >Accession Number | (0008,0050) | 2 | Not Sent |

| | | | |
|--|-------------|---|------------|
| >Placer Order Number/Imaging Service Request | (0040,2016) | 2 | Not Sent |
| >Filler Order Number/Imaging Service Request | (0040,2017) | 2 | Not Sent |
| >Requested Procedure ID | (0040,1001) | 2 | Not Sent |
| >Requested Procedure Description | (0032,1060) | 2 | Not Sent |
| >Requested Procedure Code Sequence | (0032,1064) | 2 | Not Sent |
| >>Include 'Code Sequence Macro' Table 8.8-1 | | No Baseline Context ID Number is specified. | |
| >Reason for the Requested Procedure | (0040,1002) | 3 | Not Sent |
| >Reason for Requested Procedure Code Sequence | (0040,100A) | 3 | Not Sent |
| >>Include 'Code Sequence Macro' Table 8.8-1 | | No Baseline Context ID Number is specified. | |
| Performed Procedure Code Sequence | (0040,A372) | 2 | Sent empty |
| >Include 'Code Sequence Macro' Table 8.8-1 | | No Baseline Context ID Number is specified. | |
| Current Requested Procedure Evidence Sequence | (0040,A375) | 1C | Not Sent |
| >Include ' Hierarchical SOP Instance Reference Macro' Table C.17-3 | | | |
| Pertinent Other Evidence Sequence | (0040,A385) | 1C | Not sent |
| >Include ' Hierarchical SOP Instance Reference Macro' Table C.17-3 | | | |
| Referenced Instance Sequence | (0008,114A) | 1C | Not sent |
| >Include 'SOP Instance Reference Macro' Table 10-11 | | | |
| >Purpose of Reference Code Sequence | (0040,A170) | 1 | Not sent |
| >>Include 'Code Sequence Macro' Table 8.8-1 | | | |

9.4 SR Document Content Module

The tables below capture notes concerning the values stored.

9.4.1 TID 10011 – CT Radiation Dose

| | NL | Rel with Parent | VT | Concept Name | VM | Req Type | Notes |
|---|----|-----------------|---------------|----------------------------|----|----------|-------|
| 1 | | | CONTA INER | EV (113701, DCM, "X-Ray | 1 | M | Sent |

| | | | | | | | |
|----|----|-----------------|----------|--|-----|---|---|
| | | | | Radiation Dose Report") | | | |
| 2 | > | HAS CONCEPT MOD | CODE | EV (121058, DCM, "Procedure reported") | 1 | M | Code sequence (P5-08000, SRT, Computed Tomography X-Ray) sent |
| 3 | >> | HAS CONCEPT MOD | CODE | EV (G-COE8, SRT, "Has Intent") | 1 | M | Code sequence (R-408C3, SRT, Diagnostic Intent) sent |
| 4 | > | | INCLUDE | DTID (1002) Observer Context | 1-n | M | sent with Device context values equal to Implementation UID. Single item sent.) |
| 5 | > | HAS OBS CONTEXT | DATETIME | EV (113809, DCM, "Start of X-Ray Irradiation") | 1 | M | Sent |
| 6 | > | HAS OBS CONTEXT | DATETIME | EV (113810, DCM, "End of X-Ray Irradiation") | 1 | M | Sent |
| 7 | > | HAS OBS CONTEXT | CODE | EV (113705, DCM, "Scope of Accumulation") | 1 | M | Code sequence (113014, DCM, Study) sent |
| 8 | >> | HAS PROPERTIES | UIDREF | DCID (10001) UID Types | 1 | M | Study Instance UID sent |
| 9 | > | CONTAINS | INCLUDE | DTID (10012) CT Accumulated Dose Data | 1 | M | See TID 10012 CT Accumulated Dose Data table below for details |
| 10 | > | CONTAINS | INCLUDE | DTID (10013) CT Irradiation Event Data | 1-n | M | See TID 10013 CT Irradiation Event Data table below for details |
| 11 | > | CONTAINS | TEXT | EV (121106, DCM, "Comment") | 1 | U | Not sent |
| 12 | > | CONTAINS | CODE | EV (113854, DCM, "Source of Dose Information") | 1-n | M | Not sent. |
| 13 | > | CONTAINS | INCLUDE | DTID (1020) Person Participant | 1 | U | Not sent. |

9.4.2 TID 10012 – CT Accumulated Dose Data

| | NL | Rel with Parent | VT | Concept Name | VM | Req Type | Notes |
|----|-----|-----------------|-----------|--|----|----------|----------|
| 1 | | | CONTAINER | EV (113811, DCM, "CT Accumulated Dose Data") | 1 | M | Sent |
| 2 | > | CONTAINS | NUM | EV (113812, DCM, "Total Number of Irradiation Events") | 1 | M | Sent |
| 3 | > | CONTAINS | NUM | EV (113813, DCM, "CT Dose Length Product Total") | 1 | M | Sent |
| 4 | > | CONTAINS | NUM | EV (113814, DCM, "CT Effective Dose Total") | 1 | U | Not sent |
| 5 | >> | HAS PROPERTIES | TEXT | EV (121406,DCM, "Reference Authority") | 1 | MC | Not sent |
| 6 | >> | HAS PROPERTIES | CODE | EV (121406,DCM, "Reference Authority") | 1 | MC | Not sent |
| 7 | >> | HAS CONCEPT MOD | CODE | EV (G-C036,SRT, "Measurement Method") | 1 | M | Not sent |
| 8 | >> | HAS PROPERTIES | TEXT | EV (113815,DCM, "Patient Model") | 1 | MC | Not sent |
| 9 | >> | HAS PROPERTIES | CONTAINER | EV (113816, DCM, "Condition Effective Dose measured") | 1 | MC | Not sent |
| 10 | >>> | CONTAINS | TEXT | EV (113817,DCM, "Effective Dose Phantom Type") | 1 | M | Not sent |

| | | | | | | | |
|----|-----|----------|-------------|-------------------------------------|---|----|----------|
| 11 | >>> | CONTAINS | TEXT | EV (113818, DCM, "Dosimeter Type") | 1 | M | Not sent |
| 12 | > | CONTAINS | TEXT | EV (121106, DCM, "Comment") | 1 | U | Not sent |
| 13 | > | CONTAINS | INCLU DE | DTID(1021) Device Participant | 1 | MC | Not sent |

9.4.3 TID 10013 – CT Irradiation Event Data

| | NL | Rel with Parent | VT | Concept Name | VM | Req Type | Notes |
|---|----|-----------------|---------------|---|----|----------|---|
| 1 | | | CONTA INER | EV (113819, DCM, "CT Acquisition") | 1 | M | Sent |
| 2 | > | CONTAINS | TEXT | EV (125203, DCM, "Acquisition Protocol") | 1 | U | Sent; same as Protocol Name (0018,1030) Note: In case of multiple protocols selected in one exam, last protocol selected by operator will be set for each irradiation event. |
| 3 | > | CONTAINS | CODE | EV (123014 , DCM, "Target Region") | 1 | M | Sent. See note below for specifics. Note: In case of multiple protocols selected in one exam, target region for last protocol selected by operator will be set for each irradiation event. |
| 4 | > | CONTAINS | CODE | EV (113820, DCM, "CT Acquisition Type") | 1 | M | Sent |
| 5 | > | CONTAINS | CODE | (G-C32C, SRT, "Procedure Context") | 1 | U | Not sent |
| 6 | > | CONTAINS | UIDREF | EV (113769, DCM, "Irradiation Event UID") | 1 | M | Sent; |
| 7 | > | CONTAINS | CONTA INER | EV (113822, DCM, "CT Acquisition Parameters") | 1 | M | Sent |

| | | | | | | | |
|----|-----|----------|-----------|--|-----|----|----------------------|
| 8 | >> | CONTAINS | NUM | EV (113824, DCM, "Exposure Time") | 1 | M | Sent |
| 9 | >> | CONTAINS | NUM | EV (113825, DCM, "Scanning Length") | 1 | M | Sent |
| 10 | >> | CONTAINS | NUM | EV (113826, DCM, "Nominal Single Collimation Width") | 1 | M | Sent |
| 11 | >> | CONTAINS | NUM | EV (113827, DCM, "Nominal Total Collimation Width") | 1 | M | Sent |
| 12 | >> | CONTAINS | NUM | EV (113828, DCM, "Pitch Factor") | 1 | MC | Sent per conditional |
| 13 | >> | CONTAINS | NUM | EV (113823, DCM, "Number of X-Ray Sources") | 1 | M | Sent |
| 14 | >> | CONTAINS | CONTAINER | EV (113831, DCM, "CT X-Ray Source Parameters") | 1-n | M | Single item sent. |
| 15 | >>> | CONTAINS | TEXT | EV (113832, DCM, "Identification of the X-Ray Source") | 1 | M | Sent |
| 16 | >>> | CONTAINS | NUM | EV (113733, DCM, "KVP") | 1 | M | Sent |
| 17 | >>> | CONTAINS | NUM | EV (113833, DCM, "Maximum X-Ray Tube Current") | 1 | M | Sent |
| 18 | >>> | CONTAINS | NUM | EV (113734, DCM, "X-Ray Tube Current") | 1 | M | Sent |
| 19 | >>> | CONTAINS | NUM | EV (113834, DCM, "Exposure Time per Rotation") | 1 | MC | Sent per conditional |
| 20 | >>> | CONTAINS | NUM | EV (113821, DCM, "X-Ray Filter Aluminum Equivalent") | 1 | U | Not sent |
| 21 | > | CONTAINS | CONTAINER | EV (113829, DCM, "CT Dose") | 1 | MC | Sent per conditional |

| | | | | | | | |
|----|------|-----------------|---------|--|-----|----|---|
| 22 | >> | CONTAINS | NUM | EV (113830, DCM, "Mean CTDIvol ") | 1 | M | Sent |
| 23 | >> | CONTAINS | CODE | EV (113835, DCM, "CTDIw Phantom Type") | 1 | M | Sent (IEC Head Dosimetry Phantom or IEC Body Dosimetry Phantom) |
| 24 | >> | CONTAINS | NUM | EV (113836, DCM, "CTDIfreeair Calculation Factor") | 1 | U | Not sent |
| 25 | >> | CONTAINS | NUM | EV (113837, DCM, "Mean CTDIfreeair") | 1 | U | Not sent |
| 26 | >> | CONTAINS | NUM | EV (113838, DCM, "DLP") | 1 | M | Sent |
| 27 | >> | CONTAINS | NUM | EV (113839, DCM, "Effective Dose") | 1 | U | Not sent |
| 28 | >>> | HAS CONCEPT MOD | CODE | EV (G-C036, SRT, "Measurement Method") | 1 | MC | Not sent |
| 29 | >>>> | HAS PROPERTIES | NUM | EV (113840, DCM, "Effective Dose Conversion Factor") | 1 | MC | Not sent |
| 30 | > | CONTAINS | TEXT | EV (113842, DCM, "X-Ray Modulation Type") | 1 | U | Not sent |
| 31 | > | CONTAINS | TEXT | EV (121106, DCM, "Comment") | 1 | U | Not sent |
| 32 | > | CONTAINS | INCLUDE | DTID (1020) Person Participant | 1-n | U | Not sent |
| 33 | > | CONTAINS | INCLUDE | DTID (1021) Device Participant | 1 | MC | Not sent. |

Note: Target region is filled in per the following table:

| Protocol Category | Value stored in Target Region |
|-------------------|-------------------------------|
| Head | SRT T-D1100 Head |
| Orbit | SRT T-D0801 Eye region |
| Neck | SRT T-D1600 Neck |
| Upper Extremity | SRT T-02220 Shoulder |

| | | |
|-----------------|-------------|--------------|
| Chest | SRT T-D3000 | Chest |
| Abdomen | SRT T-D4000 | Abdomen |
| Spine | SRT T-11503 | Lumbar spine |
| Pelvis | SRT T-D6000 | Pelvis |
| Lower Extremity | SRT T-D0300 | Extremity |

9.5 Configuration

The product is configured by default to not generate the CT X-Ray Radiation Dose SR Record. Creation of the CT Dose Record can be enabled via reconfig.

The product implements the CT Radiation Dose Report template (TID 10011) per DICOM Supplement 127.

The DICOM standard says that the SOP class shall be the "X-Ray Radiation Dose SR" SOP Class (1.2.840.10008.5.1.4.1.1.88.67).

However, since many PACS and workstation products may not support this SOP class, the product supports the option via reconfig to create the CT Radiation Dose Report as an "Enhanced SR" SOP Class (1.2.840.10008.5.1.4.1.1.88.22).

SR setting can be configured in "Dose Report" in reconfig menu as below.

- "Full" will produce the X-Ray Radiation Dose SR SOP class
- "On" will produce the Enhanced SR SOP class.
- "Off" will not produce any SOP class.

10 Security Conformance Statement

10.1 De-identification

The GEHC CT system satisfies the following requirements for de-identification

De-identification occurs, for example, when an anonymous patient operation is performed. This de-identification only covers DICOM attributes that contain protected patient information. The encrypted data capability is not supported, so once an image has been de-identified no facility is provided to recover the lost information.

The de-identification specified in this section only applies to GE generated images. All third party images have only the standard DICOM elements de-identified, all private tags (non-GE private tags) within these images are dropped.

De-identification supports the following object types:

- CT Image Objects

De-identification does not support the following object types:

- Secondary capture images
- Structured reports
- Grayscale presentation state objects

This de-identification specification applies when the GEHC CT system is configured for full de-identification. If the system is configured for partial de-identification, some attributes will remain unchanged.

Please note that Study ID (0020,0010) will be retained in anonymized images.

Table 10.1-1 provides the list of attributes and the expected action when de-identifying images.

**Table 10.1-1
 DICOM Attributes De-Identified**

| DICOM Tag | Attribute Name | Action | Comments |
|-----------|---|------------------|-----------------|
| 0008,0014 | Instance Creator UID | element dropped | Refer to Note 1 |
| 0008,0018 | SOP Instance UID | assign new UID | |
| 0008,0050 | Accession Number | made zero length | |
| 0008,0080 | Institution Name | made zero length | |
| 0008,0081 | Institution Address | element dropped | Refer to Note 1 |
| 0008,0090 | Referring Physician's Name | made zero length | |
| 0008,0092 | Referring Physician's Address | element dropped | Refer to Note 1 |
| 0008,0094 | Referring Physician's Telephone Numbers | element dropped | Refer to Note 1 |
| 0008,1010 | Station Name | "ANONYMIZED" | |

| DICOM Tag | Attribute Name | Action | Comments |
|------------|----------------------------------|------------------|---|
| 0008,1030 | Study Description | "ANONYMIZED" | |
| 0008,103E | Series Description | "ANONYMIZED" | |
| 0008,1040 | Institutional Department Name | element dropped | Refer to Note 1 |
| 0008,1048 | Physicians of Record | element dropped | Refer to Note 1 |
| 0008,1050 | Performing Physicians' Name | made zero length | |
| 0008,1060 | Name of Physicians Reading Study | made zero length | |
| 0008,1070 | Operators' Name | made zero length | |
| 0008,1080 | Admitting Diagnoses Description | element dropped | Refer to Note 1 |
| 0008,1110 | Referenced Study Sequence | drop sequence | |
| >0008,1150 | Referenced SOP Class UID | element dropped | |
| >0008,1155 | Referenced SOP Instance UID | element dropped | |
| 0008,1140 | Referenced Image Sequence | drop sequence | Special handling is performed when the entire exam is de-identified in one operation. See Table 10.1-2 for details. |
| >0008,1150 | Referenced SOP Class UID | element dropped | |
| >0008,1155 | Referenced SOP Instance UID | element dropped | |
| 0010,0010 | Patient's Name | "ANONxxxx" | xxxx = study id |
| 0010,0020 | Patient ID | "ANONxxxx" | xxxx = study id |
| 0010,0030 | Patient's Birth Date | made zero length | |
| 0010,0032 | Patient's Birth Time | element dropped | Refer to Note 1 |
| 0010,0040 | Patient's Sex | made zero length | |
| 0010,1000 | Other Patient Ids | made zero length | |
| 0010,1001 | Other Patient Names | element dropped | Refer to Note 1 |
| 0010,1010 | Patient's Age | made zero length | |
| 0010,1020 | Patient's Size | made zero length | |
| 0010,1030 | Patient's Weight | made zero length | |
| 0010,1090 | Medical Record Locator | element dropped | Refer to Note 1 |
| 0010,2160 | Ethnic Group | element dropped | Refer to Note 1 |
| 0010,2180 | Occupation | element dropped | Refer to Note 1 |
| 0010,21B0 | Additional Patient's History | made zero length | |
| 0010,4000 | Patient Comments | element dropped | Refer to Note 1 |
| 0018,1000 | Device Serial Number | made zero length | |
| 0018,1030 | Protocol Name | made zero length | |
| 0020,000D | Study Instance UID | assign new UID | This value is used for all images in exam |
| 0020,000E | Series Instance UID | assign new UID | This value is used for all images in series |
| 0020,0010 | Study ID | retain Study ID | This value is used in patient ID |
| 0020,0052 | Frame of Reference UID | assign new UID | This value is used for all images sharing this UID |

| DICOM Tag | Attribute Name | Action | Comments |
|-----------|--|---------------------|-----------------|
| 0020,0200 | Synchronization Frame of Reference UID | element dropped | Refer to Note 1 |
| 0020,0400 | Image Comments | made zero length | Refer to Note 1 |
| 0040,0275 | Request Attributes Sequence | retain the sequence | |
| 0040,A124 | UID | element dropped | Refer to Note 1 |
| 0040,A730 | Content Sequence | drop sequence | Refer to Note 1 |
| 0088,0140 | Storage Media File-set UID | element dropped | Refer to Note 1 |
| 3006,0024 | Referenced Frame of Reference UID | element dropped | Refer to Note 1 |
| 3006,00C2 | Related Frame of Reference UID | element dropped | Refer to Note 1 |

Note 1: these elements are not currently present in GE images, however, the described action will occur on 3rd party images.

The following special processing is performed based on image type:

**Table 10.1-2
 De-identification Processing by Image Type**

| Image Type | Processing |
|------------|---|
| CT Image | de-identified based on the tables above |
| SC Image | image discarded |
| GSPS | object discarded |
| SR | object discarded |

10.2 ASSOCIATION LEVEL SECURITY

The GEHC CT system provides association level security for Query Retrieve operations. The system will only allow remote DICOM servers to pull images if the remote DICOM server is defined on the GEHC CT system. The remote DICOM server's IP address, AE title, and Port number must be configured on the GEHC CT system for the networking pull to begin.

Note that this association level security only applies to the retrieve request; query operations will be accepted from any connected DICOM client.

APPENDIX A: CT Image and Secondary Capture

The tables below specify the modules/attributes of the CT Image and Secondary Capture Image transmitted by the Storage SCU AE.

A.1 CT Image IOD

A.1.1 CT Image IOD Modules

| Entity Name | Module Name | Reference | Usage |
|--------------------|--------------------|-----------|-------|
| Patient | Patient | A.3.1 | M |
| Study | General Study | A.3.2 | M |
| | Patient Study | A.3.3 | U |
| Series | General Series | A.3.4 | M |
| Frame of Reference | Frame of Reference | A.4.5 | M |
| Equipment | General Equipment | A.3.5 | M |
| Image | General Image | A.3.6 | M |
| | Image Plane | A.4.1 | M |
| | Image Pixel | A.4.2 | M |
| | Contrast/Bolus | A.4.3 | C |
| | CT Image | A.4.4 | M |
| | VOI LUT | A.3.7 | U |
| | SOP Common | A.3.8 | M |

A.1.1.1 Implementation Specific details

- For all CT Images created by GEHC CT patient birth date element (0010,0030) is sent, if the operator has entered the details. If the operator has not entered the details it will be sent as a “Zero length element”
- The length of Accession number element (0008,0050) is a maximum of 16 characters
 - Window Center (0028,1050) and Window Width (0028,1051) are sent for all CT Images created by GEHC CT
 - Based on whether contrast was used or not the following applies for CT Images created by GEHC CT

| Mode | (0018,0010) | (0018,1040) |
|----------------------|--|------------------------|
| No Contrast | Not sent | Not sent |
| Oral Contrast | Oral Contrast Agent name | The string “Oral” |
| IV Contrast | IV Contrast agent name | The String “IV” |
| Oral and IV contrast | Oral contrast agent “ & “ IV Contrast agent | The string “Oral & IV” |

- Supported field length for DICOM fields

| DICOM Tag | Field Name | Field Length |
|----------------|------------------|---------------------------------------|
| (0008, 0050) | Accession Number | 16 characters |
| (0010, 0010) | Patient Name | 32 characters (configurable to 64) |
| (0010, 0020) | Patient Id | 16 characters (configurable to 64) |

A.2 SC Image IOD

A.2.1 SC Image IOD Modules

| Entity Name | Module Name | Reference | Usage |
|-------------|----------------|-----------|-------|
| Patient | Patient | A.3.1 | M |
| Study | General Study | A.3.2 | M |
| | Patient Study | A.3.3 | U |
| Series | General Series | A.3.4 | M |

| | | | |
|-----------|-------------------|---|---|
| Equipment | General Equipment | A.3.5 | U |
| | SC Equipment | A.5.1 | M |
| Image | General Image | A.3.6 | M |
| | Image Pixel | A.5.2 | M |
| | SC Image | Not sent (consists entirely of type 3 element). | M |
| | Modality LUT | A.5.3 | U |
| | VOI LUT | A.3.7 | U |
| | SOP Common | A.3.8 | M |

A.2.2 CT Dose Report SC Image Details

The product is configured by default to generate a CT X-Ray Radiation Dose Report SC Image summarizing the study dose. The pixel data contains a textual, viewable report of the dose information. The next section identifies the additional standard DICOM attributes added to capture the same information as reported in the CT X-Ray Radiation Dose Record, described in Section 9.

A.2.2.1 Implementation Specific details

| Attribute Name | Tag | Type | Notes |
|----------------------------------|-------------|------|--|
| Total Number of Exposures | (0040,0301) | 3 | Total number of exposures made during this Performed Procedure Step. |
| Exposure Dose Sequence | (0040,030E) | 3 | Exposure Dose Sequence will contain Total Number of Exposures (0040,0301) items. |
| >kVp | (0018,0060) | 3 | Peak kilo voltage output |
| >X-Ray Tube Current | (0018,8151) | 3 | X-Ray tube current in microA. NOTE: the X-Ray Radiation Dose SR records this in mA. |
| >Exposure Time | (0018,1150) | 3 | Time of x-ray exposure in msec. |
| >Acquisition Type | (0018,9302) | 3 | |
| >CTDIvol | (0018,9345) | 3 | Computed Tomography Dose Index in mGy according to IEC 60601-2-44. |
| >CTDI Phantom Type Code Sequence | (0018,9346) | 3 | The type of phantom used for CTDI measurement according to IEC 60601-2-44. |
| >Single Collimation Width | (0018,9306) | 3 | The width of a single row of acquired data in mm. |
| >Total Collimation | (0018,9307) | 3 | The width of the total collimation in mm over the area of active x-ray detection. |
| >Spiral Pitch Factor | (0018,9311) | 3 | Ratio of the Table Feed per Rotation (0092,9310) to the Total Collimation Width (0018,9307) |
| >Body Part Examined | (0018,0015) | 3 | Text description of the part of the body examined. See the values for target region at the end of section 9.4.3 for the values stored. |
| Comments on Radiation Dose | (0040,0310) | 3 | Used to record total and per exposure DLP. The format is: TotalDLP=xxx DLP=xxx DLP=xxx |

A.3 Common Modules

A.3.1 Patient Module

| Attribute Name | Tag | Type | Notes |
|------------------------------|-------------|------|--|
| Patient's Name | (0010,0010) | 2 | As entered at user interface or from worklist. Supports 5 different components delimited by "^". Supports a maximum length of 32 characters including the delimiter. Can be configured to allow 64 characters. |
| Patient ID | (0010,0020) | 2 | As entered at user interface or from worklist. Supports maximum of 16 characters. Can be configured to allow 64 characters. |
| Patient's Birth Date | (0010,0030) | 2 | As entered at user interface or from worklist. |
| Patient's Sex | (0010,0040) | 2 | As entered at user interface or from worklist. |
| Referenced Patient Sequence | (0008,1120) | 3 | Value from the worklist |
| >Referenced SOP Class UID | (0008,1150) | 1C | Value from the worklist |
| >Referenced SOP Instance UID | (0008,1155) | 1C | Value from the worklist |
| Other Patient ID | (0010,1000) | 3 | Value from the worklist |

A.3.2 General Study Module

| Attribute Name | Tag | Type | Notes |
|--------------------|-------------|------|---|
| Study Instance UID | (0020,000D) | 1 | Value from worklist, if present, is used. Otherwise, the scanner creates a unique value for each exam. If worklist is reused, system can be configured to reuse the study instance uid. Default behavior is to generate a new study instance uid if the worklist is reused. |
| Study Date | (0008,0020) | 2 | Generated for each exam and always sent. |
| Study Time | (0008,0030) | 2 | Generated for each exam and always sent. |

| Attribute Name | Tag | Type | Notes |
|------------------------------------|-------------|------|--|
| Accession Number | (0008,0050) | 2 | Value from user interface or worklist sent. If worklists with different accession numbers are grouped, the default behavior is to fill in the top level accession number in the image header. The accession number can be configured to be empty in the grouped case. |
| Referring Physician's Name | (0008,0090) | 2 | Value from user interface sent. Accepts 32 characters by default but is configurable to accept 64 characters. |
| Study ID | (0020,0010) | 2 | Generated for each exam on the scanner and always sent.. |
| Study Description | (0008,1030) | 3 | When the value is imported from worklist, accepts 64 characters. When input from user interface, accepts 22 characters. |
| Name of Physician(s) Reading Study | (0008,1060) | 3 | Sent if entered at the user interface. |
| Referenced Study Sequence | (0008,1110) | 3 | Value from the worklist |
| >Referenced SOP Class UID | (0008,1150) | 1C | Value from the worklist |
| >Referenced SOP Instance UID | (0008,1155) | 1C | Value from the worklist |

A.3.3 Patient Study Module

| Attribute Name | Tag | Type | Notes |
|------------------------------|-------------|------|--|
| Patient's Age | (0010,1010) | 3 | Calculated from Date of Birth entered at user interface. |
| Patient's Size | (0010,1020) | 3 | Value from user interface or worklist sent |
| Patient's Weight | (0010,1030) | 3 | Value from user interface or worklist sent. |
| Additional Patient's History | (0010,21b0) | 3 | Value from user interface or worklist sent |

A.3.4 General Series Module

| Attribute Name | Tag | Type | Notes |
|--------------------------------------|-------------|------|---|
| Series Number | (0020,0011) | 2 | Generated sequentially, always sent. |
| Laterality | (0020,0060) | 2C | Not sent. |
| Series Date | (0008,0021) | 3 | Generated for each series and always sent. |
| Series Time | (0008,0031) | 3 | Generated for each series and always sent. |
| Modality | (0008,0060) | 1 | Always sent as "CT" |
| Performing Physician's Name | (0008,1050) | 3 | Mapped from (0040, 0006) in the worklist. |
| Protocol Name | (0018,1030) | 3 | Sent if entered at user interface. |
| Series Description | (0008,103E) | 3 | Value from user interface is sent. |
| Operator's Name | (0008,1070) | 3 | Value from user interface is sent. |
| Patient Position | (0018,5100) | 2C | Sent. As selected by operator when patient is positioned. Defined terms are: HFP = Head-First Prone HFS = Head-First Supine HFDR = Head-First Decubitus Right HFDL = Head-First Decubitus Left FFDR = Feet-First Decubitus Right FFDL = Feet-First Decubitus Left FFP = Feet-First Prone FFS = Feet-First Supine |
| Series Instance UID | (0020,000E) | 1 | Always sent |
| Performed Procedure Step Start Date | (0040,0244) | 3 | Sent when MPPS option is enabled |
| Performed Procedure Step Start Time | (0040,0245) | 3 | Sent when MPPS option is enabled |
| Performed Procedure Step ID | (0040,0253) | 3 | Sent when MPPS option is enabled |
| Performed Procedure Step Description | (0040,0254) | 3 | Sent when MPPS option is enabled |
| Requested Attributes Sequence | (0040,0275) | 3 | Sent when MPPS option is enabled and filled in based on what RIS provides to scanner. Number of items relates to number of items selected from Patient Schedule. |
| > Requested Procedure ID | (0040,1001) | 1C | Always sent, copied from RIS |

| | | | |
|--|-------------|----|---|
| > Accession Number | (0008,0050) | 3 | Value from worklist sent |
| > Referenced Study Sequence | (0008,1110) | 3 | Value from worklist sent |
| > Study Instance UID | (0020,000D) | 3 | Value from worklist sent |
| > Requested Procedure Desc | (0032,1060) | 3 | Value from worklist sent |
| > Requested Procedure Code Sequence | (0032,1064) | 3 | Value from worklist sent |
| > Scheduled Procedure Step Desc | (0040,0007) | 3 | Value from worklist sent |
| > Scheduled Protocol Code Sequence | (0040,0008) | 3 | Value from worklist sent |
| > Scheduled Procedure Step ID | (0040,0009) | 3 | Value from worklist sent |
| > Reason for Requested Procedure | (0040,1002) | 3 | Not sent. |
| > Reason for Requested Procedure Code sequence | (0040,1004) | 3 | Not sent. |
| Body Part Examined | (0018,0015) | 3 | Not sent. |
| Referenced Performed Procedure Step Sequence | (0008,1111) | 3 | Value used for performed procedure step |
| >Referenced SOP Class UID | (0008,1150) | 1C | Value used for performed procedure step |
| >Referenced SOP Instance UID | (0008,1155) | 1C | Value used for performed procedure step |

A.3.5 General Equipment Module

| Attribute Name | Tag | Type | Notes |
|--------------------------|-------------|------|---|
| Manufacturer | (0008,0070) | 2 | Always sent as "GE MEDICAL SYSTEMS" |
| Institution Name | (0008,0080) | 3 | Sent. Value is configurable. |
| Station Name | (0008,1010) | 3 | Sent. Value is configurable. |
| Manufacturers Model Name | (0008,1090) | 3 | Sent. |
| Device Serial Number | (0018,1000) | 3 | Sent, Using Gantry Serial number from Product Locator tool. |
| Software Versions | (0018,1020) | 3 | Sent. |

| Attribute Name | Tag | Type | Notes |
|---------------------|-------------|------|-------|
| Pixel Padding Value | (0028,0120) | 3 | Sent. |

A.3.6 General Image Module

| Attribute Name | Tag | Type | Notes |
|---------------------|-------------|------|---|
| Image Number | (0020,0013) | 2 | Generated sequentially, always sent. |
| Patient Orientation | (0020,0020) | 2C | Always sent zero length for SC images. |
| Content Date | (0008,0023) | 2C | Generated for each image, always sent. |
| Content Time | (0008,0033) | 2C | Generated for each image, always sent. |
| Image Type | (0008,0008) | 3 | <p>Always sent.</p> <p>Value 3: CT Image IOD specific specializations AXIAL LOCALIZER SEGMENTED REFORMATTED PROCESSED COMBINED CTINTERVENTION</p> <p>Value 4: GE CT Image implementation specific MIN IP MIP AVERAGE VOLREN INTEGRAL HD MIP RAYSUM SURFACE MINMAX FLUORO</p> |
| Acquisition Number | (0020,0012) | 3 | Generated for each acquisition, always sent. |
| Acquisition Date | (0008,0022) | 3 | Generated for each acquisition, always sent. |
| Acquisition Time | (0008,0032) | 3 | Generated for each acquisition, always sent. Format is in fractional seconds as small as 1 millionth of a second. |

| | | | |
|-----------------------------|-------------|---|---|
| Referenced Image Sequence | (0008,1140) | 3 | Value from the worklist |
| >Reference SOP Class UID | (0008,1150) | 1 | Value from the worklist |
| >Reference SOP Instance UID | (0008,1155) | 1 | Value from the worklist |
| Irradiation Event UID | (0008,3010) | 3 | Always sent. Note: This tag gets empty when generate image from scan file of old software version. |

A.3.7 VOI LUT Module

| Attribute Name | Tag | Type | Notes |
|----------------|-------------|------|---|
| Window Center | (0028,1050) | 1C | Window Center for display. Always sent. |
| Window Width | (0028,1051) | 1C | Window Width for display. Always sent. |

A.3.8 SOP Common Module

| Attribute Name | Tag | Type | Notes |
|------------------------|-------------|------|--------------|
| SOP Class UID | (0008,0016) | 1 | Always sent. |
| SOP Instance UID | (0008,0018) | 1 | Always sent. |
| Specific Character Set | (0008,0005) | 1C | ISO_IR 100 |
| Instance Creation Date | (0008,0012) | 3 | Always sent. |
| Instance Creation Time | (0008,0013) | 3 | Always sent. |
| Instance Number | (0020,0013) | 3 | Always sent. |

A.3.9 Enhanced General Equipment Module

| Attribute Name | Tag | Type | Notes |
|--------------------------|-------------|------|--|
| Manufacturer | (0008,0070) | 1 | Always sent as "GE MEDICAL SYSTEMS" |
| Manufacturers Model Name | (0008,1090) | 1 | Sent. |
| Device Serial Number | (0018,1000) | 1 | Sent as serial number entered into product locator tool. |
| Software Versions | (0018,1020) | 1 | Sent. |

A.4 CT Image Modules

A.4.1 Image Plane Module

| Attribute Name | Tag | Type | Notes |
|----------------------|-------------|------|--|
| Slice Thickness | (0018,0050) | 2 | Value always sent. |
| Image Slice Location | (0020,1041) | 3 | Value always sent. Note: Slice Location reflects the gantry ISO center table location value for the image in mm. If the gantry is tilted, this value will differ from the image position (0020, 0032) Z value which reflects the upper left-hand voxel (center of the first voxel transmitted) of the grid, in mm in the registered Frame of Reference. The system can be configured to save the upper left-hand corner Z coordinate value into (0020, 1041) Slice Location instead of the gantry ISO center table location. |
| Image Position | (0020,0032) | 1 | Always sent. System configuration allows images to be flipped and rotated. Default behavior is to not allow flip and rotate. Note that the Image Position reflects the x, y and z coordinate of the upper left corner of the first voxel transmitted instead of the center of the first voxel transmitted. |
| Image Orientation | (0020,0037) | 1 | Always sent. System configuration allows images to be flipped and rotated. Default behavior is to not allow flip and rotate. |
| Pixel Spacing | (0028,0030) | 1 | Always sent |

A.4.2 Image Pixel Module

| Attribute Name | Tag | Type | Notes |
|----------------------------|-------------|------|-----------------------------|
| Samples per Pixel | (0028,0002) | 1 | Always sent with value = 1 |
| Photometric Interpretation | (0028,0004) | 1 | Always sent. |
| Rows | (0028,0010) | 1 | Always sent |
| Columns | (0028,0011) | 1 | Always sent |
| Bits Allocated | (0028,0100) | 1 | Always sent with value = 16 |
| Bits Stored | (0028,0101) | 1 | Always sent with value = 16 |
| High Bit | (0028,0102) | 1 | Always sent with value = 15 |

| | | | |
|----------------------|-------------|---|----------------------------|
| Pixel Representation | (0028,0103) | 1 | Always sent with value = 1 |
| Pixel Data | (7FE0,0010) | 1 | Always sent |

A.4.3 Contrast Bolus Module

| Attribute Name | Tag | Type | Notes |
|----------------------|-------------|------|--|
| Contrast/Bolus Agent | (0018,0010) | 2 | Sent if contrast exam, as entered in user interface. |
| Contrast/Bolus Route | (0018,1040) | 3 | Sent if contrast exam, as entered in user interface. |

A.4.4 CT Image Module

| Attribute Name | Tag | Type | Notes |
|----------------------------|-------------|------|--|
| Image Type | (0008,0008) | 1 | Always sent. Defined terms: Value 3: AXIAL LOCALIZER SEGMENTED REFORMATTED PROCESSED COMBINED CTINTERVENTION Value 4: MIN IP MIP AVERAGE VOLREN INTEGRAL HD MIP RAYSUM SURFACE MINMAX FLUORO |
| Samples per Pixel | (0028,0002) | 1 | Always sent with value = 1 |
| Photometric Interpretation | (0028,0004) | 1 | Always sent |
| Bits Allocated | (0028,0100) | 1 | Always sent with value = 16 |

| Attribute Name | Tag | Type | Notes |
|-----------------------------|-------------|------|---|
| Bits Stored | (0028,0101) | 1 | Always sent with value = 16 |
| High Bit | (0028,0102) | 1 | Always sent with value = 15 |
| Rescale Intercept | (0028,1052) | 1 | Always sent |
| Rescale Slope | (0028,1053) | 1 | Always sent |
| Rescale Type | (0028,1054) | 1C | Always sent with value = HU |
| KV | (0018,0060) | 2 | Value always sent. |
| Acquisition Number | (0020,0012) | 2 | Value always sent. |
| Scan Options | (0018,0022) | 3 | Value always sent. Defined Terms : AXIAL MODE SCOUT MODE AXIAL XRON MODE AXIAL XROFF MODE STATIC XRON MODE STATIC XROFF MODE TUBE HEAT MODE DAS MODE TUBE CAL MODE BIOPSY MODE CINE MODE HELICAL MODE ROTGENCAL MODE FLUORO MODE |
| Data Collection Diameter | (0018,0090) | 3 | Value always sent. |
| Reconstruction Diameter | (0018,1100) | 3 | Value sent for all images except scouts. |
| Distance Source to Detector | (0018,1110) | 3 | Value always sent. |
| Distance Source to Patient | (0018,1111) | 3 | Value always sent. |
| Gantry / Detector Tilt | (0018,1120) | 3 | Value always sent. |
| Table Height | (0018,1130) | 3 | Value always sent. |
| Rotation Direction | (0018,1140) | 3 | Not sent for scout or axial. |
| Exposure Time | (0018,1150) | 3 | Value always sent. |
| X-Ray Tube Current | (0018,1151) | 3 | Value always sent. |
| Exposure | (0018,1152) | 3 | Value always sent. (See Note below) |
| Filter Type | (0018,1160) | 3 | Sent. |

| Attribute Name | Tag | Type | Notes |
|--------------------------|--------------|------|--|
| | | | Defined terms: BODY FILTER MEDIUM FILTER HEAD FILTER |
| Generator Power | (0018,1170) | 3 | Always sent |
| Focal Spot | (0018,1190) | 3 | Sent. Fixed value of 0.7 or 1.2. |
| Convolution Kernel | (0018,1210) | 3 | Not sent for scouts. Defined terms: SMOOTH SOFT STANDARD STD+ DETAIL BONE BONEPLUS CHST EDGE SHARP LUNG ULTRA |
| Revolution Time | (0018, 9305) | 3 | Sent for spiral scan only |
| Single Collimation Width | (0018, 9306) | 3 | Sent for spiral scan only |
| Total Collimation Width | (0018, 9307) | 3 | Sent for spiral scan only |
| Table Speed | (0018, 9309) | 3 | Sent for spiral scan only |
| Table Feed per Rotation | (0018, 9310) | 3 | Sent for spiral scan only |
| Spiral Pitch Factor | (0018, 9311) | 3 | Sent for spiral scan only |

CAUTION It is possible for the operator of GEHC CT system to change the table height while scanning a series of images. Therefore, implementations must use the Frame of Reference UID (0020,0052) in conjunction with the Table Height (0018,1130) to determine if two images are spatially related.

Decsription of how to calculate the Dicom Exposure field (0018,1152)

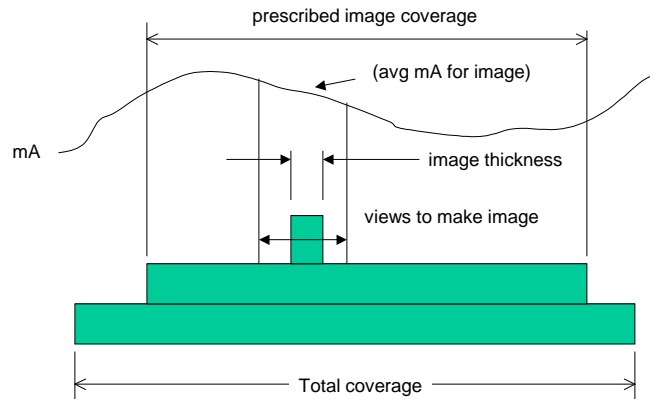

$$\text{exposure} = (\text{exposure time}) * (\text{image avg mA}) * (\text{slice thickness}) / (\text{total coverage})$$

exposure time = total x-ray on time
 helical total coverage= (exposure time * table velocity)
 axial or cine total coverage = macro row thickness * no of active rows
 Slice thickness = nominal prospective reconstructed slice selection

Exposure.ppt
 T. Toth 03-Aug-04

Note:

A.4.5 Frame of Reference Module

| Attribute Name | Tag | Type | Notes |
|------------------------------|-------------|------|---|
| Frame of Reference UID | (0020,0052) | 1 | See Caution below. |
| Position Reference Indicator | (0020,1040) | 2 | Value as entered at the user interface. |

CAUTION It is possible for the operator of GEHC CT system to change the table height while scanning a series of images. Therefore, implementations must use the Frame of Reference UID (0020,0052) in conjunction with the Table Height (0018,1130) to determine if two images are spatially related.

A.4.6 Other Attributes

| Attribute Name | Tag | Type | Notes |
|-------------------------------------|-------------|------|---|
| Temporal Position Index | (0020,9128) | 3 | Not Sent |
| Nominal Percentage of Cardiac Phase | (0020,9241) | 3 | Filled into CT image for some applications. Prescribed percentage of cardiac phase. |
| Creator Version UID | (0008,9123) | 3 | Not Sent. |

A.5 SC Image Modules

A.5.1 SC Equipment Module

| Attribute Name | Tag | Type | Notes |
|-----------------|-------------|------|---|
| Conversion Type | (0008,0064) | 1 | Always sent with value WSD |
| Modality | (0008,0060) | 3 | Modality of original image. This will not be sent, if its value is NULL. |

A.5.2 Image Pixel Module

| Attribute Name | Tag | Type | Notes |
|----------------------------|-------------|------|-----------------------------|
| Samples per Pixel | (0028,0002) | 1 | Always sent with value = 1 |
| Photometric Interpretation | (0028,0004) | 1 | Always sent. |
| Rows | (0028,0010) | 1 | Always sent |
| Columns | (0028,0011) | 1 | Always sent |
| Bits Allocated | (0028,0100) | 1 | Always sent with value = 16 |
| Bits Stored | (0028,0101) | 1 | Always sent with value = 16 |
| High Bit | (0028,0102) | 1 | Always sent with value = 15 |
| Pixel Representation | (0028,0103) | 1 | Always sent with value = 1 |
| Pixel Data | (7FE0,0010) | 1 | Always sent |

A.5.3 Modality LUT Module

| Attribute Name | Tag | Type | Notes |
|-------------------|-------------|------|-----------------------------|
| Rescale Intercept | (0028,1052) | 1C | Always sent |
| Rescale Slope | (0028,1053) | 1C | Always sent |
| Rescale Type | (0028,1054) | 1C | Always sent with value = HU |

APPENDIX B: Private Data Elements

Enclosed is a listing of private data elements used in this implementation for CT Image IOD definition.

B.1 CT Image IOD Private Data Elements Definition

B.1.1 Private Creator Identification (GEMS_IDEN_01)

| Attribute Name | Tag | VR | VM |
|------------------------|-------------|----|----|
| Full Fidelity | (0009,1001) | LO | 1 |
| Suite ID | (0009,1002) | SH | 1 |
| Product ID | (0009,1004) | SH | 1 |
| Actual Image Date/time | (0009,1027) | SL | 1 |
| Equipment UID | (0009,10E3) | UI | 1 |

Note: For all images created by GEHC CT system (0009,1001) element will have the value "CT_LIGHTSPEED".

B.1.2 Private Creator Identification (GEMS_ACQU_01)

| Attribute Name | Tag | VR | VM |
|-------------------------------|-------------|----|----|
| Number of cells I in Detector | (0019,1002) | SL | 1 |
| Cell number at Theta | (0019,1003) | DS | 1 |
| Cell spacing | (0019,1004) | DS | 1 |
| Horizontal Landmark | (0019,100F) | DS | 1 |
| Series contrast | (0019,1011) | SS | 1 |
| RAS for first scan loc | (0019,1018) | LO | 1 |
| RAS for last scan loc | (0019,101A) | LO | 1 |
| Table speed | (0019,1023) | DS | 1 |
| Mid scan time | (0019,1024) | DS | 1 |
| Mid scan flag | (0019,1025) | SS | 1 |
| Degrees of azimuth | (0019,1026) | SL | 1 |
| Gantry period | (0019,1027) | DS | 1 |
| Number of triggers | (0019,102C) | SL | 1 |
| Angle of first view | (0019,102E) | DS | 1 |
| Trigger frequency | (0019,102F) | DS | 1 |
| Scan FOV type | (0019,1039) | SS | 1 |
| Segment number | (0019,1042) | SS | 1 |
| Total segments requested | (0019,1043) | SS | 1 |
| View compression factor | (0019,1047) | SS | 1 |
| Recon post proc. Flag | (0019,1052) | SS | 1 |

| Attribute Name | Tag | VR | VM |
|----------------------------------|-------------|----|----|
| dependent on no. views processed | (0019,106A) | SS | 1 |

B.1.3 Private Creator Identification (GEMS_RELA_01)

| Attribute Name | Tag | VR | VM |
|------------------------------|-------------|----|----|
| Series from which Prescribed | (0021,1003) | SS | 1 |
| Series Prescribed From | (0021,1035) | SS | 1 |
| Image Prescribed From | (0021,1036) | SS | 1 |
| Biopsy position | (0021,1091) | SS | 1 |
| Biopsy T location | (0021,1092) | FL | 1 |
| Biopsy ref location | (0021,1093) | FL | 1 |

B.1.4 Private Creator Identification (GEMS_STDY_01)

| Attribute Name | Tag | VR | VM |
|---------------------------------|-------------|----|----|
| Start time(secs) in first axial | (0023,1070) | FD | 1 |

B.1.5 Private Creator Identification (GEMS_IMAG_01)

| Attribute Name | Tag | VR | VM |
|-------------------------------|-------------|----|----|
| Scout Type | (0027,1010) | SS | 1 |
| Vma mamp | (0027,101C) | SL | 1 |
| Vma mod | (0027,101E) | SL | 1 |
| GE Noise Index * 10 | (0027,101F) | SL | 1 |
| Smart scan ON/OFF flag | (0027,1020) | SS | 1 |
| Plane Type | (0027,1035) | SS | 1 |
| Center R coord of plane image | (0027,1042) | FL | 1 |
| Center A coord of plane image | (0027,1043) | FL | 1 |
| Center S coord of plane image | (0027,1044) | FL | 1 |
| Normal R coord | (0027,1045) | FL | 1 |
| Normal A coord | (0027,1046) | FL | 1 |
| Normal S coord | (0027,1047) | FL | 1 |
| Table start location | (0027,1050) | FL | 1 |
| Table end location | (0027,1051) | FL | 1 |

B.1.6 Private Creator Identification (GEMS_0039)

| Attribute Name | Tag | VR | VM |
|---------------------|-------------|----|----|
| SR Application Name | (0039,1095) | LO | 1 |

B.1.7 Private Creator Identification (GEMS_CT_FLRO_1)

| Attribute Name | Tag | VR | VM |
|------------------------|-------------|----|----|
| CT Int Fluoro | (0029,1001) | SS | 1 |
| Image Precise Location | (0029,1002) | DS | 1 |

B.1.8 Private Creator Identification (GEMS_PARM_01)

| Attribute Name | Tag | VR | VM |
|--------------------------------|-------------|----|----|
| Window value | (0043,1010) | US | 1 |
| X-ray chain | (0043,1012) | SS | 3 |
| Number of overranges | (0043,1016) | SS | 1 |
| Delta start time | (0043,101E) | DS | 1 |
| Max overranges in a view | (0043,101F) | SL | 1 |
| Corrected after glow terms | (0043,1021) | SS | 1 |
| Reference channels | (0043,1025) | SS | 6 |
| No views ref chans blocked | (0043,1026) | US | 4 |
| Scan pitch ratio | (0043,1027) | SH | 1 |
| Unique Image Id in pxl hdr | (0043,1028) | OB | 1 |
| Private Scan Options | (0043,102B) | SS | 4 |
| RA cord of target recon center | (0043,1031) | DS | 2 |
| Trigger on position | (0043,1040) | FL | 1 |
| Degree of rotation | (0043,1041) | FL | 1 |
| DAS trigger source | (0043,1042) | SL | 1 |
| DAS fpa gain | (0043,1043) | SL | 1 |
| DAS output source | (0043,1044) | SL | 1 |
| DAS ad input | (0043,1045) | SL | 1 |
| DAS cal mode | (0043,1046) | SL | 1 |
| Start scan to X-ray on delay | (0043,104D) | FL | 1 |
| Duration of X-ray on | (0043,104E) | FL | 1 |
| Recon filter | (0043,1064) | LO | 1 |

B.1.9 Private Creator Identification (GEMS_HELIOS_01)

Note: Dicom elements (0045, 1030-1034) and (0045, 1036-1039) and (0045, 103B) are present only if the appropriate cardiac option is installed on the scanner.

| Attribute Name | Tag | VR | VM |
|----------------------------------|--------------|----|----|
| Number of Macro Rows in Detector | (0045, 1001) | SS | 1 |
| Macro width at ISO Center | (0045, 1002) | FL | 1 |
| DAS type | (0045, 1003) | SS | 1 |
| DAS gain | (0045, 1004) | SS | 1 |
| Table Direction | (0045, 1006) | CS | 1 |
| Z smoothing Factor | (0045, 1007) | FL | 1 |

| Attribute Name | Tag | VR | VM |
|---|--------------|----|----|
| View Weighting Mode | (0045, 1008) | SS | 1 |
| Sigma Row number | (0045, 1009) | SS | 1 |
| Minimum DAS value | (0045, 100A) | FL | 1 |
| Maximum Offset Value | (0045, 100B) | FL | 1 |
| Number of Views shifted | (0045, 100C) | SS | 1 |
| Z tracking Flag | (0045, 100D) | SS | 1 |
| Mean Z error | (0045, 100E) | FL | 1 |
| Z tracking Error | (0045, 100F) | FL | 1 |
| Start View 2A | (0045, 1010) | SS | 1 |
| Number of Views 2A | (0045, 1011) | SS | 1 |
| Start View 1A | (0045, 1012) | SS | 1 |
| Sigma Mode | (0045, 1013) | SS | 1 |
| Number of Views 1A | (0045, 1014) | SS | 1 |
| Start View 2B | (0045, 1015) | SS | 1 |
| Number Views 2B | (0045, 1016) | SS | 1 |
| Start View 1B | (0045, 1017) | SS | 1 |
| Number of Views 1B | (0045, 1018) | SS | 1 |
| Itebone Flag | (0045, 1021) | SS | 1 |
| Peristaltic Flag | (0045, 1022) | SS | 1 |
| CardiacReconAlgorithm | (0045, 1030) | CS | 1 |
| AvgHeartRateForImage | (0045, 1031) | CS | 1 |
| Temporal Resolution | (0045, 1032) | FL | 1 |
| PctRpeakDelay | (0045, 1033) | CS | 1 |
| ActualPctRpeakDelay | (0045, 1034) | CS | 1 |
| EkgFullMaStartPhase | (0045, 1036) | CS | 1 |
| EkgFullMaEndPhase | (0045, 1037) | CS | 1 |
| EkgModulationMaxMa | (0045, 1038) | CS | 1 |
| EkgModulationMinMa | (0045, 1039) | CS | 1 |
| Noise Reduction Image Filter Description | (0045, 103B) | LO | 1 |
| RPeakTimeDelay | (0045, 103F) | IS | 1 |
| ActualRPeakTimeDelay | (0045, 1044) | IS | 1 |
| CardiacScanOptions | (0045, 1045) | ST | 1 |

B.1.10 Private Creator Identification (GEMS_CT_CARDIAC_001)

Note: Private Group 49 is present only if the appropriate cardiac option is installed on the scanner.

| Attribute Name | Tag | VR | VM |
|----------------------------|--------------|----|----|
| CT Cardiac Sequence | (0049, 1001) | SQ | 1 |
| HeartRateAtConfirm | (0049, 1002) | CS | 1 |
| AvgHeartRatePriorToConfirm | (0049, 1003) | FL | 1 |
| MinHeartRatePriorToConfirm | (0049, 1004) | CS | 1 |

| | | | |
|-----------------------------------|--------------|----|-------|
| MaxHeartRatePriorToConfirm | (0049, 1005) | CS | 1 |
| StdDevHeartRatePriorToConfirm | (0049, 1006) | FL | 1 |
| NumHeartRateSamplesPriorToConfirm | (0049, 1007) | US | 1 |
| AutoHeartRateDetectPredict | (0049, 1008) | CS | 1 |
| SystemOptimizedHeartRate | (0049, 1009) | CS | 1 |
| EkgMonitorType | (0049, 100A) | ST | 1 |
| NumReconSectors | (0049, 100B) | CS | 1 |
| RpeakTimeStamps | (0049, 100C) | FL | 1-256 |
| EkgGatingType | (0049, 1016) | SH | 1 |
| EkgWaveTimeOffFirstDataPoint | (0049, 101B) | FL | 1 |
| TemporalAlg | (0049, 1022) | CS | 1 |
| PhaseLocation | (0049, 1023) | CS | 1 |
| PreBlendedCycle1 | (0049, 1024) | OW | 1 |
| PreBlendedCycle2 | (0049, 1025) | OW | 1 |
| CompressionAlg | (0049, 1026) | CS | 1 |

B.1.11 Private Creator Identification (GEHC_CT_ADVAPP_001)

| Attribute Name | Tag | VR | VM |
|--------------------------------|--------------|----|----|
| ShuttleFlag | (0053, 1020) | IS | 1 |
| TableSpeedNotReachesTargetFlag | (0053, 1021) | IS | 1 |
| IterativeReconAnnotation | (0053, 1040) | SH | 1 |
| IterativeReconMode | (0053, 1041) | SH | 1 |
| IterativeReconConfiguration | (0053, 1042) | LO | 1 |
| IterativeReconLevel | (0053, 1043) | SH | 1 |
| reconFlipRotateAnno | (0053, 1060) | SH | 1 |
| HighResolutionFlag | (0053, 1061) | SH | 1 |
| RespiratoryFlag | (0053, 1062) | SH | 1 |
| Image Position Patient Setting | (0053, 1063) | CS | 1 |
| Shutter Flag | (0053, 1064) | IS | 1 |
| Shutter Mode Percent | (0053, 1065) | IS | 1 |
| Image Browser Annotation | (0053, 1066) | LO | 1 |
| Overlapped Recon Flag | (0053, 1067) | IS | 1 |
| Row Number Annotation Flag | (0053, 1068) | IS | 1 |
| ImageCheckAnnotation | (0053, 1069) | LO | 1 |
| ODMFlag | (0053, 106A) | IS | 1 |
| ODMReductionPercent | (0053, 106B) | IS | 1 |

APPENDIX C: DICOMDIR Directory Information

Enclosed here is a listing of only the optional (conditional) modules and optional attributes used by this implementation in the DICOMDIR definition. All standard attributes as defined in Part 3 Addendum (Basic Directory Information Object) are supported by this implementation but not listed here.

C.1 Basic Directory IOD Definition

| Module | Usage | Notes |
|-------------------------|-------|-------|
| Directory Information | U | Sent |
| File Set Identification | M | Sent |

C.2 File Set Identification Module

| Attribute Name | Tag | Type | Notes |
|----------------|-------------|------|--------------------|
| File Set ID | (0004,1130) | 2 | Set by application |

C.3 Directory Information Module

| Attribute Name | Tag | Type | Notes |
|---|-------------|------|--|
| Offset of the First Directory Record of the Root Directory Entity | (0004,1200) | 1 | Set by application |
| Offset of the Last Directory Record of the Root Directory Entity | (0004,1202) | 1 | Set by application |
| File-set Consistency Flag | (0004,1212) | 1 | 0000H: no known inconsistencies. |
| Directory Record Sequence | (0004,1220) | 2 | Supported. |
| >Offset of the Next Directory Record | (0004,1400) | 1 | Set by application |
| >Record In-use Flag | (0004,1410) | 1 | FFFFH: record is in use |
| >Offset of Referenced Lower-Level Directory Entity | (0004,1420) | 1 | Set by application |
| >Directory Record Type | (0004,1430) | 1 | "PATIENT", "STUDY", "SERIES", "IMAGE", "PRESENTATION" and "SR DOCUMENT" |
| >Referenced File ID | (0004,1500) | 1C | Generated only for Image, Presentation and SR Document Directory Records, starting with A/A/A/A/Z01. |

| | | | |
|---|-------------|----|---|
| >Referenced SOP Class UID in file | (0004,1510) | 1C | Generated only for Image, Presentation and SR Document Directory Records |
| >Referenced SOP Instance UID in File | (0004,1511) | 1C | Generated only for Image, Presentation and SR Document Directory Records. Set to SOP Instance UID (0008,0018) during save to media. |
| >Referenced Transfer Syntax UID in File | (0004,1512) | 1C | Generated only for Image, Presentation and SR Document Directory Records |
| >Record Selection Keys | | | See C.4 |

C.4 Definition of Specific Directory Records

STD-GEN-CD, STD-GEN-DVD-JPEG and STD-GEN-USB-JPEG Application Profiles will have PATIENT, STUDY, SERIES, IMAGE, PRESENTATION and SR DOCUMENT directory record types. Given below are the attributes supported under each of these directories.

Additional Keys column in each list specifies whether each key is an additional key for STD-GEN-CD, STD-GEN-DVD-JPEG and STD-GEN-USB-JPEG or not.

C.4.1 Patient Directory Record Definition

| Attribute Name | Tag | Type (for CD) | Type (for DVD / USB) | Notes |
|------------------------|-------------|---------------|----------------------|--|
| Specific Character Set | (0008,0005) | 1C | 1C | ISO_IR 100 |
| Patient's Name | (0010,0010) | 2 | 2 | If present in composite object instances it will be set to same value, otherwise set to NULL |
| Patient ID | (0010,0020) | 1 | 1 | If present in composite object instances it will be set to same value, otherwise method as stated in section C.4.1.1 is followed to set the value. |
| Patient Birth Date | (0010,0030) | E | 1C | If present in composite object instances it will be set to same value, otherwise not present |
| Patient Birth Time | (0010,0032) | E | E | If present in composite object instances it will be set to same value, otherwise not present |
| Patient Sex | (0010,0040) | E | 1C | If present in composite object |

| | | | | |
|--|--|--|--|---|
| | | | | instances it will be set to same value, otherwise not present |
|--|--|--|--|---|

NOTE: E represents Standard Extended Element

C.4.1.1 Methods to set Patient ID

```

dummyPatID = 0;
if (patientID is present in the image)
{
    put patientID value in DICOMDIR
}
else
{
    if (current image is of same study)
    {
        put "no_patID" + dummyPatID
    }
    else if (current image is not of same study)
    {
        put "no_patID" + (++dummyPatID)
    }
}
    
```

Later point of time, if we get the patient ID then the above dummy patient ID should be updated with the actual patient ID.

Scenario:

=====

For example if we are adding 8 images, and 4 images are of Series S1 and 4 images are of series S2 belonging to the same Study as S1. Series S1 images are not having any value for patient ID but series S2 images are having the value of patient ID. Now while DICOMDIR creation, initially we would put dummy patient ID value when iterating through series S1 but when we reach to the second series image then previously filled dummy patient ID should be filled with the actual patient ID found in series S2 images.

Another example: if several series belong to a same Study without Patient ID in any of the images, a single Patient ID (i.e. a single Directory Record) is assigned to this Study, and all Series are attached to the Study they belong to. Do not duplicate Study UIDs (i.e. do not generate two Directory Records with the same Study UID).

C.4.2 Study Directory Record Definition

| Attribute Name | Tag | Type (for CD) | Type (for DVD / USB) | Notes |
|----------------|-----|---------------|----------------------|-------|
|----------------|-----|---------------|----------------------|-------|

| | | | | |
|------------------------|-------------|----|----|---|
| Specific Character Set | (0008,0005) | 1C | 1C | ISO_IR 100 |
| Study Date | (0008,0020) | 1 | 1 | If present in composite object instances it will be set to same value, otherwise method as stated in sec C.4.2.1 is followed to set the value. |
| Study Time | (0008,0030) | 1 | 1 | If present in composite object instances it will be set to same value, otherwise method as stated in sec C.4.2.1 is followed to set the value. |
| Accession Number | (0008,0050) | 2 | 2 | If present in composite object instances it will be set to same value, otherwise set to NULL |
| Study Description | (0008,1030) | 2 | 2 | If present in composite object instances it will be set to same value, otherwise set to NULL |
| Study Instance UID | (0020,000D) | 1C | 1C | This is set to value that is present in the composite object instances, otherwise composite object instances are not Archived. |
| Study ID | (0020,0010) | 1 | 1 | If present in composite object instances it will be set to same value, otherwise method as stated in section C.4.2.2 is followed to set the value |

C.4.2.1 Method to set Study Date and Time

```

if (studyDateTime is present)
{
    put its value in DICOMDIR
}
else
{
    look for seriesDateTime
    if (seriesDateTime is present)
    {
        put seriesDateTime value in DICOMDIR
    }
    else
    {
        look for acquisitionDateTime (either ((0008,0022),(0008,0032)) or (0008,002A))
        if (acquisitionDateTime is present)
        {

```

```

        put acquisitionDateTime value in DICOMDIR
    }
    else
    {
        look for contentDateTime
        if(contentDateTime is present)
        {
            put contentDateTime value in DICOMDIR
        }
        else
        {
            look for instanceCreationDateTime
            if(instanceCreationDateTime is present)
            {
                put instanceCreationDateTime value in DICOMDIR
            }
            else
            {
                put a DummyDateTime
            }
        }
    }
}
}
}

```

Ideally, the oldest Date-Time found among all images belonging to the Study should be stored in DICOMDIR.

C.4.2.2 Method to set Study ID

```

if (studyID is present in the image)
{
    put studyID value in DICOMDIR
}
else
{
    put a dummy studyID value in DICOMDIR. please take care of the length (< 16)
}

```

Later point of time, if correct Study ID is found in any of the image present in the Study then dummy Study ID has to be replaced with correct one.

C.4.3 Series Directory Record Definition

| Attribute Name | Tag | Type (for CD) | Type (for DVD / USB) | Notes |
|----------------|-----|------------------|-------------------------|-------|
|----------------|-----|------------------|-------------------------|-------|

| | | | | |
|-----------------------------|-------------|----|----|--|
| Specific Character Set | (0008,0005) | 1C | 1C | ISO_IR 100 |
| Image Type | (0008,0008) | E | E | If present in composite object instances it will be set to same value, otherwise not sent |
| Modality | (0008,0060) | 1 | 1 | If present in composite object instance it will be set to same value, otherwise an error is returned and the object not put on media |
| Manufacturer | (0008,0070) | E | E | If present in composite object instances it will be set to same value, otherwise not sent |
| Institution Name | (0008,0080) | E | 1C | If present in composite object instances it will be set to same value, otherwise not sent |
| Institution Address | (0008,0081) | E | 1C | If present in composite object instances it will be set to same value, otherwise not sent |
| Series Description | (0008,103E) | E | 3 | If present in composite object instances it will be set to same value, otherwise not sent |
| Performing Physician's Name | (0008,1050) | E | 1C | If present in composite object instances it will be set to same value, otherwise not sent |
| Manufacturer's Model Name | (0008,1090) | E | E | If present in composite object instances it will be set to same value, otherwise not sent |
| Series Instance UID | (0020,000E) | 1 | 1 | This is set to value that is present in the composite object instance, otherwise check for presence of Referenced SOP Instance UID in File (0004,1511), if both not present, instance is not put on media. |
| Series Number | (0020,0011) | 1 | 1 | If present in composite object instance, it will be set to same value, otherwise method as stated in section C.4.3.1 is followed to set the value. |

NOTE: E represents Standard Extended Element.

C.4.3.1 Method to set Series Number

```

dummySeriesNum = 0;
if (seriesNum is present in image)
{
    put seriesNum value in DICOMDIR
}
else
{
    if (same series)
    {
        put dummySeriesNum value in DICOMDIR
    }
    else (different series)
    {
        put (++dummySeriesNum) value in DICOMDIR
    }
}
  
```

Later point of time, if correct series Num is found in any of the image present in the series then dummy series number has to be replaced with correct one.

C.4.4 Image Directory Record Definition

| Attribute Name | Tag | Type (for CD) | Type (for DVD / USB) | Notes |
|---------------------------|-------------|---------------|----------------------|--|
| Specific Character Set | (0008,0005) | 1C | 1C | ISO_IR 100 |
| Image Type | (0008,0008) | 1C | 1C | If present in composite object instances it will be set to same value, otherwise not sent |
| SOP Instance UID | (0008,0018) | E | E | Same as (0004,1511) |
| Acquisition Datetime | (0008,002A) | E | 1C | If present in composite object instances it will be set to same value, otherwise not sent. |
| Acquisition Time | (0008,0032) | E | E | If present in composite object instances it will be set to same value, otherwise not sent |
| Referenced Image Sequence | (0008,1140) | 1C | 1C | If present in composite object instances it will be set to same value, otherwise not sent |

| | | | | |
|--|-------------|----|----|--|
| >Reference SOP Class UID | (0008,1150) | 1C | 1C | Required if Referenced Image Sequence (0008,1140) is present |
| >Reference SOP Instance UID | (0008,1155) | 1C | 1C | Required if Referenced Image Sequence (0008,1140) is present |
| Slice Thickness | (0018,0050) | E | E | Included |
| Spacing Between Slices | (0018,0088) | E | E | Included |
| Data Collection Diameter | (0018,0090) | E | E | Included |
| Reconstruction Diameter | (0018,1100) | E | E | Included |
| Gantry/Detector Tilt | (0018,1120) | E | E | Included |
| Convolution Kernel | (0018,1210) | E | E | Included |
| Acquisition Time Synchronized | (0018,1800) | E | 1C | If present in composite object instances it will be set to same value, otherwise not sent. |
| Image Number | (0020,0013) | 1 | 1 | If present in composite object instances it will be set to same value. otherwise method as stated in section C.4.4.1 is followed to set the value. |
| Image Position (Patient) | (0020,0032) | E | 1C | If present in composite object instances it will be set to same value, otherwise not sent |
| Image Orientation (Patient) | (0020,0037) | E | 1C | If present in composite object instances it will be set to same value, otherwise not sent |
| Frame of Reference UID | (0020,0052) | E | 1C | If present in composite object instances it will be set to same value, otherwise not sent |
| Synchronization Frame of Reference UID | (0020,0200) | E | 1C | If present in composite object instances it will be set to same value, otherwise not sent |
| Slice Location | (0020,1041) | E | E | Included |
| Number of Frames | (0028,0008) | E | 1C | Not included |
| Rows | (0028,0010) | E | 1 | If present in composite object instances it will be set to |

| | | | | |
|-------------------------------|-------------|---|----|---|
| | | | | same value, otherwise an error is returned |
| Columns | (0028,0011) | E | 1 | If present in composite object instances it will be set to same value, otherwise an error is returned |
| Pixel Spacing | (0028,0030) | E | 1C | If present in composite object instances it will be set to same value, otherwise not sent |
| Bits Allocated | (0028,0100) | E | 1 | Not included |
| Bits Stored | (0028,0101) | E | 1 | Not included |
| High Bit | (0028,0102) | E | 1 | Not included |
| Lossy Image Compression Ratio | (0028,2112) | E | 1C | If present in composite object instances it will be set to same value, otherwise not sent |
| Calibration Image | (0050,0004) | E | 1C | If present in composite object instances it will be set to same value, otherwise not sent |

NOTE: E represents Standard Extended Element.

C.4.4.1 Method to set Image Number

```

dummyImageNum = 0;
if (imageNum is present in image)
{
    put imageNum value in DICOMDIR
}
else
{
    put ++ dummyImageNum in DICOMDIR
}
  
```

C.4.5 Presentation Directory Record Definition

| Attribute Name | Tag | Type (for CD) | Type (for DVD / USB) | Notes |
|------------------------|-------------|---------------|----------------------|------------|
| Specific Character Set | (0008,0005) | 1C | 1C | ISO_IR 100 |

| | | | | |
|-------------------------------|-------------|----|----|---|
| SOP Instance UID | (0008,0018) | E | E | Same as (0004,1511) |
| Referenced Series Sequence | (0008,1115) | 1C | 1C | Calculated and sent. |
| > Referenced Image Sequence | (0008,1140) | 1 | 1 | Always sent, references images selected. |
| >> Reference SOP Class UID | (0008,1150) | 1 | 1 | Always sent |
| >> Reference SOP Instance UID | (0008,1155) | 1 | 1 | Always sent |
| > Series Instance UID | (0020,000E) | 1 | 1 | Always sent, references series selected |
| Image Number | (0020,0013) | 1 | 1 | If present in composite object instances it will be set to same value. otherwise method as stated in section C.4.4.1 is followed to set the value. Set to 23 and sent. |
| Content Label | (0070,0080) | 1 | 1 | Exam Split : This will be set as "PGP" plus Requested Procedure Code Meaning or Requested Procedure Description converted to all capital letters and truncated to 16 characters. Save State : "GEGSPS_0" |
| Content Description | (0070,0081) | 2 | 2 | Exam Split : String input on Comments box in Exam Split screen Save State : "SE (Series Number) IM (First Image Number) TO IM (Last Image Number)" |
| Presentation Creation Date | (0070,0082) | 1 | 1 | Calculated and sent. |
| Presentation Creation Time | (0070,0083) | 1 | 1 | Calculated and sent. |
| Content Creator's Name | (0070,0084) | 2 | 2 | Same as Station Name(0008,1010) |

NOTE: E represents Standard Extended Element.

C.4.6 Structured Report Directory Record Definition

| Attribute Name | Tag | Type (for CD) | Type (for DVD / USB) | Notes |
|----------------------------|-------------|---------------|----------------------|---|
| Specific Character Set | (0008,0005) | 1C | 1C | ISO_IR 100 |
| SOP Instance UID | (0008,0018) | E | E | Same as (0004,1511) |
| Image Date | (0008,0023) | 1 | 1 | Generated for each image, always sent. |
| Image Time | (0008,0033) | 1 | 1 | Generated for each image, always sent. |
| Image Number | (0020,0013) | 1 | 1 | If present in composite object instances it will be set to same value. otherwise method as stated in section C.4.4.1 is followed to set the value. |
| Concept Name Code Sequence | (0040,A043) | 1 | 1 | A coded representation of the document title. |
| >Code Value | (0008,0100) | 1 | 1 | Always sent |
| >Coding Scheme Designator | (0008,0102) | 1 | 1 | Always sent |
| >Code Meaning | (0008,0104) | 1 | 1 | Always sent |
| Completion Flag | (0040,A491) | 1 | 1 | COMPLETE sent |
| Verification Flag | (0040,A493) | 1 | 1 | UNVERIFIED sent |
| Content Sequence | (0040,A730) | 1C | 1C | Contains the Target Content Items that modify the Concept Name Code Sequence of the root Content Item (Document Title). One or more Items shall be included in this Sequence. All, and only, Content Items with the HAS CONCEPT MOD relationship from the root Content Item shall be included in this Sequence. Required if the root Content Item is the Source Content Item of HAS CONCEPT MOD relationships. |
| >Relationship Type | (0040,A010) | 1 | 1 | Enumerated Value: HAS CONCEPT MOD |

NOTE: E represents Standard Extended Element.

APPENDIX D: Implementation UID for Product Versions

| Product Model | Software Revision | Implementation UID |
|--------------------------|-------------------|----------------------|
| BrightSpeed Elite | 17BW11.* | 1.2.840.113619.6.278 |
| BrightSpeed Elite Select | 17BW11.* | 1.2.840.113619.6.278 |
| Optima CT540 | 17BW24.* | 1.2.840.113619.6.278 |
| Optima CT520 Series | 17BW24.* | 1.2.840.113619.6.278 |

GE Healthcare
3000 N. Grandview Blvd., Waukesha, WI 53188 U.S.A.

www.gehealthcare.com



Imagination at work

