



Technical Publications

Direction DOC1570233

Revision 3

CT DICOM CONFORMANCE STATEMENT

Revolution™ Discovery™ CT

Discovery™ CT

Discovery™ CT750 HD

* Refer to section 1 for a list of products to which this Conformance Statement applies.



Page Left Intentionally Blank

LEGAL NOTES

TRADEMARKS

All products and their name brands are trademarks of their respective holders.

OMISSIONS & ERRORS

Customers, please contact your GE Sales or Service representatives.

GE personnel, please use the GE Healthcare PQR Process to report all omissions, errors, and defects in this publication.

Copyrights

All Material Copyright (c) 2014 by the General Electric Company, All rights reserved.

REVISION HISTORY

REV.	VER	DATE	REASON FOR CHANGE
1	1	30 Jun 2014	Initial Draft
2	1	19 Sep 2014	Update for SW 14MW24.7 release
3	1	8 Oct 2014	Update per global review comments

Page Left Intentionally Blank

CONFORMANCE STATEMENT OVERVIEW

This DICOM Conformance Statement captures the DICOM capabilities of the GEHC CT scanners identified below. This document applies to the following software release of the product:

Revolution™ Discovery™ CT	14MW24.7
Discovery™ CT	14MW24.7
Discovery™ CT750 HD	14MW24.7

Table 0.1 provides an overview of the network services supported by GEHC CT products identified above

Table 0.1 – NETWORK SERVICES

SOP Classes	User of Service (SCU)	Provider of Service (SCP)
Transfer		
CT Image Storage	Yes	Yes
MR Image Storage	Yes	Yes
Secondary Capture Image Storage	Yes	Yes
Grayscale Softcopy Presentation State Storage	Yes	No
Enhanced SR Storage	Yes	Yes
X-Ray Radiation Dose SR – CT Radiation Dose	Yes	Yes
RT Structure Set Storage	Yes	Yes
Positron Emission Tomography Image Storage	Yes	Yes
Query/Retrieve		
Study Root Query/Retrieve Information Model – FIND	Yes	Yes
Study Root Query/Retrieve Information Model – MOVE	Yes	Yes
Print Management		
Basic Grayscale Print Management Meta SOP Class	Yes	No
Basic Color Print Management Meta SOP Class	Yes	No
Printer SOP Class	Yes	No
Workflow Management		
Storage Commitment Push Model SOP Class	Yes	No
Modality Performed Procedure Step SOP Class	Yes	No
Basic Modality Worklist Information Model – FIND SOP Class	Yes	No

Table 0.2 provides an overview of the Media Storage Application Profiles supported by the CT products identified above.

Table 0.2 - MEDIA SERVICES

Media Storage Application Profile	Write Files (FSC or FSU)	Read Files (FSR)
Compact Disk – Recordable		
STD-GEN-CD	Yes / No	Yes
DVD		
STD-GEN-DVD-JPEG	Yes / N/A	No
USB		
STD-GEN-USB-JPEG	Yes / N/A	Yes

TABLE OF CONTENTS

1	INTRODUCTION	12
1.1	OVERVIEW	12
1.2	OVERALL CONFORMANCE STATEMENT DOCUMENTATION STRUCTURE	14
1.3	INTENDED AUDIENCE	15
1.4	SCOPE AND FIELD OF APPLICATION	15
1.5	IMPORTANT REMARKS	16
1.6	REFERENCES.....	17
1.7	DEFINITIONS.....	17
1.8	SYMBOLS AND ABBREVIATIONS	19
2	NETWORK CONFORMANCE STATEMENT	20
2.1	INTRODUCTION.....	20
2.2	IMPLEMENTATION MODEL.....	20
2.2.1	<i>Application Data Flow Diagram</i>	21
2.2.2	<i>Functional Definition of AE's</i>	24
2.2.3	<i>Sequencing of Real-World Activities</i>	26
2.3	AE SPECIFICATIONS	26
2.3.1	<i>DICOM Server AE Specification</i>	26
2.4	COMMUNICATION PROFILES	79
2.4.1	<i>Supported Communication Stacks (parts 8)</i>	79
2.4.2	<i>TCP/IP Stack</i>	79
2.4.3	<i>Others</i>	79
2.5	EXTENSIONS / SPECIALIZATIONS / PRIVATIZATIONS	79
2.5.1	<i>Standard Extended Elements</i>	79
2.5.2	<i>Private Data Elements</i>	79
2.6	CONFIGURATION.....	79
2.6.1	<i>AE Title/Presentation Address Mapping</i>	79
2.6.2	<i>Configurable Parameters</i>	79
2.7	SUPPORT OF EXTENDED CHARACTER SETS.....	82
2.8	CODES AND CONTROLLED TERMINOLOGY.....	83
2.8.1	<i>Mapped Coded Terminology</i>	83
2.9	SECURITY PROFILES	83
3	MEDIA STORAGE CONFORMANCE STATEMENT	83
3.1	INTRODUCTION.....	83
3.2	IMPLEMENTATION MODEL.....	84
3.2.1	<i>Application Data Flow Diagram</i>	84
3.2.2	<i>Functional Definitions of AE's</i>	86
3.2.3	<i>Sequencing of Real World Activities</i>	86
3.2.4	<i>File Meta Information for Implementation Class and Version</i>	86
3.3	AE SPECIFICATIONS	86
3.3.1	<i>DICOM CD-R/CD-RW/DVD-R/DVD-RW/USB Media Interchange AE Specification</i> .	87
3.4	AUGMENTED AND PRIVATE APPLICATION PROFILES	95
3.4.1	<i>Augmented Application Profiles</i>	95
3.4.2	<i>Private Application Profiles</i>	95
3.5	EXTENSIONS, SPECIALIZATIONS AND PRIVATIZATION OF SOP CLASSES AND TRANSFER SYNTAX.....	95
3.5.1	<i>Extensions, Specialization's and Privatizations of SOP Classes</i>	95
3.5.2	<i>Private Transfer Syntax Specification</i>	96
3.6	CONFIGURATION.....	96

3.7	SUPPORT OF EXTENDED CHARACTER SETS.....	96
3.8	IHE INTEGRATION	96
3.8.1	<i>IHE PDI</i>	96
4	PRINT MANAGEMENT IMPLEMENTATION	98
4.1	INTRODUCTION.....	98
4.2	BASIC FILM SESSION SOP CLASS	98
4.2.1	<i>Basic Film Session N-Create Attributes</i>	98
4.3	BASIC FILM BOX SOP CLASS.....	99
4.3.1	<i>Basic Film Box N-Create Attributes</i>	99
4.3.2	<i>Basic Film Box N-Action Attributes</i>	100
4.3.3	<i>Basic Film Box N-Delete</i>	101
4.4	BASIC GRAYSCALE IMAGE BOX SOP CLASS	101
4.5	BASIC COLOR IMAGE BOX SOP CLASS	102
4.6	PRINTER SOP CLASS	103
5	STORAGE COMMITMENT PUSH MODEL IMPLEMENTATION	105
5.1	STORAGE COMMITMENT PUSH MODEL INFORMATION OBJECT DEFINITION	105
5.1.1	<i>Storage Commitment Module for N-ACTION</i>	105
5.1.2	<i>Storage Commitment Module for N-EVENT-REPORT</i>	105
6	MODALITY WORKLIST QUERY IMPLEMENTATION	107
6.1	MODALITY WORKLIST INFORMATION MODEL DEFINITION	107
6.1.1	<i>Introduction</i>	107
6.1.2	<i>Modality Worklist Information Model Description</i>	107
6.1.3	<i>Modality Worklist Information Model Entity-Relationship Model</i>	107
6.1.4	<i>Modality Worklist Mapping of DICOM Entities</i>	109
6.1.5	<i>Modality Worklist Information Model Module</i>	109
6.1.6	<i>Information Model Keys</i>	110
6.2	PRIVATE DATA DICTIONARY.....	118
6.3	C-FIND REQUEST MESSAGE	119
6.4	USE OF SPECIFIC DICOM DATA	121
6.5	SETTING USER PREFERENCES	123
6.5.1	<i>Setting "Use MWL Study UID " Option</i>	123
6.5.2	<i>Setting Custom Query Option</i>	123
7	MODALITY PERFORMED PROCEDURE STEP IMPLEMENTATION	125
7.1	INTRODUCTION.....	125
7.2	N-CREATE & N-SET REQUEST MESSAGE.....	125
7.3	MODALITY PERFORMED PROCEDURE STEP MODULE DEFINITIONS	127
7.4	USE OF SPECIFIC DICOM DATA	130
7.4.1	<i>Patient Level</i>	130
7.4.2	<i>Study Level</i>	130
7.4.3	<i>Series Level</i>	131
8	GRAYSCALE SOFTCOPY PRESENTATION STATE IMPLEMENTATION	132
8.1	INTRODUCTION.....	132
8.2	CT MAPPING OF DICOM ENTITIES.....	132
8.3	IOD MODULE TABLE.....	132
8.4	INFORMATION MODULE DEFINITIONS.....	133
8.4.1	<i>Patient Entity Module</i>	133
8.4.2	<i>Study Entity Module</i>	133
8.4.3	<i>Series Entity Module</i>	134
8.4.4	<i>Equipment Module</i>	136
8.4.5	<i>Presentation State Entity Module</i>	137

8.5	IMAGE HEADER CHANGES SUPPORTING GSPS	139
8.5.1	<i>Request Attributes Sequence</i>	139
9	STRUCTURED REPORT INFORMATION OBJECT IMPLEMENTATION.....	140
9.1	IOD MODULE TABLE.....	140
9.2	SR DOCUMENT SERIES MODULE	140
9.3	ENHANCED EQUIPMENT MODEL IMPLEMENTATION	140
9.4	SR DOCUMENT GENERAL MODULE	141
9.5	SR DOCUMENT CONTENT MODULE.....	142
9.5.1	<i>TID 10011 – CT Radiation Dose</i>	143
9.5.2	<i>TID 10012 – CT Accumulated Dose Data</i>	144
9.5.3	<i>TID 10013 – CT Irradiation Event Data</i>	145
9.5.4	<i>TID 10014 - Scanning Length</i>	147
9.5.5	<i>TID 10015 – CT Dose Check Details</i>	148
9.5.6	<i>TID 1002 – Observer Context</i>	149
9.5.7	<i>TID 1004 – Device Observer Identifying Attributes</i>	150
9.5.8	<i>TID 1020 – Person Participant</i>	150
9.6	CONFIGURATION.....	151
10	SECURITY CONFORMANCE STATEMENT	152
10.1	DE-IDENTIFICATION	152
APPENDIX A:	CT IMAGE AND SECONDARY CAPTURE	155
A.1	CT IMAGE IOD.....	155
A.1.1	<i>CT Image IOD Modules</i>	155
A.2	SC IMAGE IOD.....	156
A.2.1	<i>SC Image IOD Modules</i>	156
A.2.2	<i>CT Dose Report SC Image Details</i>	157
A.3	COMMON MODULES.....	159
A.3.1	<i>Patient Module</i>	159
A.3.2	<i>General Study Module</i>	159
A.3.3	<i>Patient Study Module</i>	160
A.3.4	<i>General Series Module</i>	160
A.3.5	<i>General Equipment Module</i>	162
A.3.6	<i>General Image Module</i>	162
A.3.7	<i>VOI LUT Module</i>	164
A.3.8	<i>SOP Common Module</i>	164
A.4	CT IMAGE MODULES.....	164
A.4.1	<i>Image Plane Module</i>	164
A.4.2	<i>Image Pixel Module</i>	165
A.4.3	<i>Contrast Bolus Module</i>	165
A.4.4	<i>CT Image Module</i>	165
A.4.5	<i>Frame of Reference Module</i>	169
A.4.6	<i>Other Attributes</i>	169
A.5	SC IMAGE MODULES.....	170
A.5.1	<i>SC Equipment Module</i>	170
A.5.2	<i>Image Pixel Module</i>	170
A.5.3	<i>Modality LUT Module</i>	170
APPENDIX B:	PRIVATE DATA ELEMENTS	171
B.1	CT IMAGE IOD PRIVATE DATA ELEMENTS DEFINITION	171
B.1.1	<i>Private Creator Identification (GEMS_IDEN_01)</i>	171
B.1.2	<i>Private Creator Identification (GEMS_ACQU_01)</i>	171
B.1.3	<i>Private Creator Identification (GEMS_RELA_01)</i>	172
B.1.4	<i>Private Creator Identification (GEMS_STDY_01)</i>	172
B.1.5	<i>Private Creator Identification (GEMS_IMAG_01)</i>	172

B.1.6	<i>Private Creator Identification (GEMS_0039)</i>	172
B.1.7	<i>Private Creator Identification (GEMS_CT_FLRO_1)</i>	172
B.1.8	<i>Private Creator Identification (GEMS_PARM_01)</i>	173
B.1.9	<i>Private Creator Identification (GEMS_HELIOS_01)</i>	173
B.1.10	<i>Private Creator Identification (GEMS_CT_CARDIAC_001)</i>	174
B.1.11	<i>Private Creator Identification (GEHC_CT_ADVAPP_001)</i>	175
APPENDIX C:	DICOMDIR DIRECTORY INFORMATION	177
C.1	BASIC DIRECTORY IOD DEFINITION	177
C.2	FILE SET IDENTIFICATION MODULE	177
C.3	DIRECTORY INFORMATION MODULE	177
C.4	DEFINITION OF SPECIFIC DIRECTORY RECORDS	178
C.4.1	<i>Patient Directory Record Definition</i>	178
C.4.2	<i>Study Directory Record Definition</i>	179
C.4.3	<i>Series Directory Record Definition</i>	181
C.4.4	<i>Image Directory Record Definition</i>	183
C.4.5	<i>Presentation Directory Record Definition</i>	185
C.4.6	<i>Structured Report Directory Record Definition</i>	186
APPENDIX D:	IMPLEMENTATION UID FOR PRODUCT VERSIONS	188

1 Introduction

Note: Throughout this entire document the term “GEHC CT” refers to the following products:

- Revolution™ Discovery CT
- Discovery™ CT
- Discovery™ CT750 HD

This document applies to the following software releases for Revolution/Discovery Product:

- | | |
|---------------------------|----------|
| Revolution™ Discovery™ CT | 14MW24.7 |
| Discovery™ CT | 14MW24.7 |
| Discovery™ CT750 HD | 14MW24.7 |

Note: The GEHC CT product lines present an Image Works desktop, which contains advanced applications offered on the Advantage Workstation. The DICOM Conformance Statements related to these applications can be found at the following website:

<http://www.ge.com/DICOM>

Advanced Application	DICOM Conformance Statement Reference on website
GSI Viewer	GSI Viewer 2.1 DOC0636569 Rev 3
Cardiac (Card IQ Xpress Reveal, CardEP)	Volume Viewer and its Applications (Release 10.x) 5404107-100 Rev. 2
CT Perfusion 4D - Neuro and Multi-Organ	CT Perfusion V4.0 2329613-100 Rev 0
Reformat	Volume Viewer and its Applications (Release 10.x) 5404107-100 Rev. 2
Volume Viewer	Volume Viewer and its Applications (Release 10.x) 5404107-100 Rev. 2
CT_Colono_Pro3D_EC	Volume Viewer and its Applications (Release 10.x) 5404107-100 Rev. 2
AVA_Xpress	Volume Viewer and its Applications (Release 10.x) 5404107-100 Rev. 2

1.1 Overview

This DICOM Conformance Statement is divided into Sections as described below:

Section 1 (Introduction), which describes the overall structure, intent, and references for this Conformance Statement.

Section 2 (Network Conformance Statement), which specifies the GEHC CT compliance to the DICOM requirements for the implementation of Networking features.

Section 3 (Media Storage Conformance Statement), which specifies the GEHC CT compliance to the DICOM requirements for the implementation of Media Storage features.

Section 4 (Print Management Implementation), which specifies the GEHC CT compliance to DICOM requirements for the implementation of the Print management service.

Section 5, (Storage Commitment Push Model Implementation), which specifies the GEHC CT compliance to DICOM requirements for the implementation of the Storage Commitment service, to store the images using remote DICOM entity, which is Storage Commitment SCP.

Section 6, (Modality Worklist Query Implementation), which specifies the GEHC CT compliance to DICOM requirements for the implementation of the Modality Worklist service. ModalityWorklist is providing the DICOM C-FIND service as a service class user (SCU).

Section 7, (Modality Performed Procedure Step Implementation), which specifies the GEHC CT compliance to DICOM requirements for the implementation of the Modality Performed Procedure Step service. The PPS option allows a Modality Performed Procedure Step to be communicated to the Hospital/Radiology information system. The PPS feature is providing the DICOM Modality Performed Procedure Step service as a service class user (SCU).

Section 8, (Grayscale Softcopy Presentation State Implementation), which specifies the GEHC CT compliance to DICOM requirements for the implementation of the Grayscale Softcopy Presentation State IOD. The Virtual Exam Split Option for GEHC CT provides the DICOM Modality GSPS service as a service class user (SCU).

Section 9, (Structured Report Information Object Implementation), which specifies the GEHC CT compliance to DICOM requirements for the implementation of the CT X-ray Radiation Dose / Enhanced Structured Report.

Section 10, (Security Conformance Statement), which specifies the de-identification for CT images provided by GEHC CT system.

Appendix A, which specifies the CT IOD and Secondary Capture information object.

Appendix B, which specifies the Private data element definition for CT IOD.

Appendix C, which specifies the DICOMDIR directory information.

Appendix D, which specifies Implementation UIDs for different CT product versions.

1.2 Overall Conformance Statement Documentation Structure

The Documentation Structure of the GEHC DICOM Conformance Statements is shown in the illustration below.

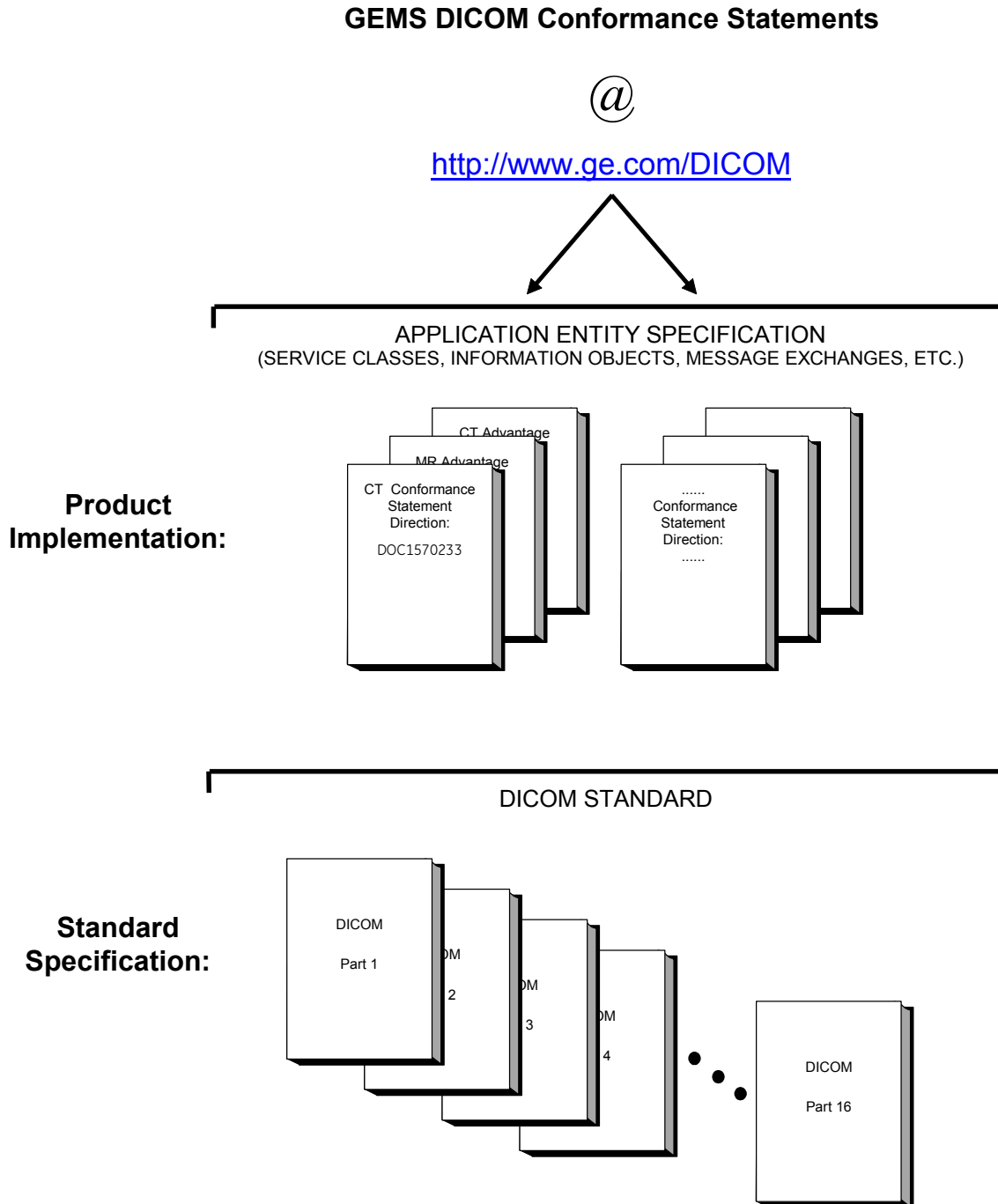

This document specifies the DICOM implementation. It is entitled:

DICOM Conformance Statement (Revolution Discovery CT/Discovery CT/Discovery CT750 HD)

Conformance Statement for DICOM

Direction DOC1570233

This DICOM Conformance Statement documents the DICOM Conformance Statement and Technical Specification required to interoperate with the GEHC network interface.

The GEHC Conformance Statement, contained in this document, also specifies the Lower Layer communications, which it supports (e.g., TCP/IP). However, the Technical Specifications are defined in the DICOM Part 8 standard.

For more information regarding DICOM, copies of the Standard may be obtained on the Internet at <http://medical.nema.org>. Comments on the Standard may be addressed to:

DICOM Secretariat

NEMA

1300 N. 17th Street, Suite 1752

Rosslyn, VA 22209

USA

Phone : +1.703.841.320

1.3 Intended Audience

The reader of this document is concerned with software design and/or system integration issues. It is assumed that the reader of this document is familiar with the DICOM Standard and with the terminology and concepts, that are used in that Standard.

1.4 Scope and Field of Application

It is the intent of this document to provide an unambiguous specification for GEHC implementations. This specification, called a Conformance Statement, includes a DICOM Conformance Statement and is necessary to ensure proper processing and interpretation of GEHC medical data exchanged using DICOM. The GEHC Conformance Statements are available to the public.

The reader of this DICOM Conformance Statement should be aware that different GEHC devices are capable of using different Information Object Definitions. For example, a GEHC CT Scanner may send images using the CT Information Object, MR Information Object, Secondary Capture Object, etc.

Included in this DICOM Conformance Statement are the Module Definitions used by this GEHC implementation. If the user encounters unspecified private data elements while parsing a GEHC Data

Set, the user is well advised to ignore those data elements (per the DICOM standard). Unspecified private data element information is subject to change without notice. If, however, the device is acting as a "full fidelity storage device", it should retain and re-transmit all of the private data elements that are sent by GEHC devices.

1.5 Important Remarks

The use of these Conformance Statements, in conjunction with the DICOM Standards, is intended to facilitate communication with GE imaging equipment. However, **by itself, it is not sufficient to insure that inter-operation will be successful.** The **user (or user's agent)** needs to proceed with caution and address at least four issues:

- **Integration**

The integration of any device into an overall system of interconnected devices goes beyond the scope of standards (DICOM), and of this introduction and associated Conformance Statements when interoperability with non-GE equipment is desired. The responsibility to analyze the applications requirements and to design a solution that integrates GE imaging equipment with non-GE systems is the **user's** responsibility and should not be underestimated. The **user** is strongly advised to ensure that such integration analysis is correctly performed.

- **Validation**

Testing the complete range of possible interactions between any GE device and non-GE devices, before the connection is declared operational, should not be overlooked. Therefore, the user should ensure that any non-GE provider accepts full responsibility for all validation required for their connection with GE devices. This includes the accuracy of the image data once it has crossed the interface between the GE imaging equipment and the non-GE device and the stability of the image data for the intended applications.

Such a validation is required before any clinical use (diagnosis and/or treatment) is performed. It applies when images acquired on GE imaging equipment are processed/displayed on a non-GE device, as well as when images acquired on non-GE equipment is processed/displayed on a GE console or workstation.

- **Future Evolution**

GE understands that the DICOM Standard will evolve to meet the user's growing requirements. GE is actively involved in the development of the DICOM Standard. DICOM will incorporate new features and technologies and GE may follow the evolution of the Standard. Evolution of the Standard may require changes to devices that have implemented DICOM. In addition, GE reserves the right to discontinue or make changes to the support of communications features (on its products) reflected on by these DICOM Conformance Statements. The user should ensure that any non-GE provider, which connects with GE devices, also plans future evolution of the DICOM standard. Failure to do so will likely result in the loss of function and/or connectivity as the DICOM Standard changes and GE products are enhanced to support these changes.

- **Interaction**

It is the sole responsibility of the non-GE provider to ensure that communications with the interfaced equipment does not cause degradation of GE imaging equipment performance and/or function.

1.6 References

NEMA PS3 Digital Imaging and Communications in Medicine (DICOM) Standard, available free at <http://medical.nema.org/>

1.7 Definitions

Informal definitions are provided for the following terms used in this Conformance Statement. The DICOM Standard is the authoritative source for formal definitions of these terms.

Abstract Syntax – the information agreed to be exchanged between applications, generally equivalent to a Service/Object Pair (SOP) Class. Examples : Verification SOP Class, Modality Worklist Information Model Find SOP Class, Computed Radiography Image Storage SOP Class.

Application Entity (AE) – an end point of a DICOM information exchange, including the DICOM network or media interface software; i.e., the software that sends or receives DICOM information objects or messages. A single device may have multiple Application Entities.

Application Entity Title – the externally known name of an *Application Entity*, used to identify a DICOM application to other DICOM applications on the network.

Application Context – the specification of the type of communication used between *Application Entities*. Example: DICOM network protocol.

Association – a network communication channel set up between *Application Entities*.

Attribute – a unit of information in an object definition; a data element identified by a *tag*. The information may be a complex data structure (Sequence), itself composed of lower level data elements. Examples: Patient ID (0010,0020), Accession Number (0008,0050), Photometric Interpretation (0028,0004), Procedure Code Sequence (0008,1032).

Information Object Definition (IOD) – the specified set of *Attributes* that comprise a type of data object; does not represent a specific instance of the data object, but rather a class of similar data objects that have the same properties. The *Attributes* may be specified as Mandatory (Type 1), Required but possibly unknown (Type 2), or Optional (Type 3), and there may be conditions associated with the use of an Attribute (Types 1C and 2C). Examples: MR Image IOD, CT Image IOD.

Joint Photographic Experts Group (JPEG) – a set of standardized image compression techniques, available for use by DICOM applications.

Media Application Profile – the specification of DICOM information objects and encoding exchanged on removable media (e.g., CDs)

Module – a set of *Attributes* within an *Information Object Definition* that are logically related to each other. Example: Patient Module includes Patient Name, Patient ID, Patient Birth Date, and Patient Sex.

Negotiation – first phase of *Association* establishment that allows *Application Entities* to agree on the types of data to be exchanged and how that data will be encoded.

Presentation Context – the set of DICOM network services used over an *Association*, as negotiated between *Application Entities*; includes *Abstract Syntaxes* and *Transfer Syntaxes*.

Protocol Data Unit (PDU) – a packet (piece) of a DICOM message sent across the network. Devices must specify the maximum size packet they can receive for DICOM messages.

Security Profile – a set of mechanisms, such as encryption, user authentication, or digital signatures, used by an *Application Entity* to ensure confidentiality, integrity, and/or availability of exchanged DICOM data

Service Class Provider (SCP) – role of an *Application Entity* that provides a DICOM network service; typically, a server that performs operations requested by another *Application Entity* (*Service Class User*). Examples: Picture Archiving and Communication System (image storage SCP, and image query/retrieve SCP), Radiology Information System (modality worklist SCP).

Service Class User (SCU) – role of an *Application Entity* that uses a DICOM network service; typically, a client. Examples: imaging modality (image storage SCU, and modality worklist SCU), imaging workstation (image query/retrieve SCU)

Service/Object Pair (SOP) Class – the specification of the network or media transfer (service) of a particular type of data (object); the fundamental unit of DICOM interoperability specification. Examples: Ultrasound Image Storage Service, Basic Grayscale Print Management.

Service/Object Pair (SOP) Instance – an information object; a specific occurrence of information exchanged in a *SOP Class*. Examples: a specific x-ray image.

Tag – a 32-bit identifier for a data element, represented as a pair of four digit hexadecimal numbers, the “group” and the “element”. If the “group” number is odd, the tag is for a private (manufacturer-specific) data element. Examples: (0010,0020) [Patient ID], (07FE,0010) [Pixel Data], (0019,0210) [private data element]

Transfer Syntax – the encoding used for exchange of DICOM information objects and messages. Examples: *JPEG* compressed (images), little endian explicit value representation.

Unique Identifier (UID) – a globally unique “dotted decimal” string that identifies a specific object or a class of objects; an ISO-8824 Object Identifier. Examples: Study Instance UID, SOP Class UID, SOP Instance UID.

Value Representation (VR) – the format type of an individual DICOM data element, such as text, an integer, a person’s name, or a code. DICOM information objects can be transmitted with either explicit identification of the type of each data element (Explicit VR), or without explicit identification

(Implicit VR); with Implicit VR, the receiving application must use a DICOM data dictionary to look up the format of each data

1.8 Symbols and Abbreviations

AE	Application Entity
CD-R	Compact Disk Recordable
CT	Computed Tomography
DICOM	Digital Imaging and Communications in Medicine
FSC	File-Set Creator
FSU	File-Set Updater
FSR	File-Set Reader
GSPS	Grayscale Softcopy Presentation State
HIS	Hospital Information System
IHE	Integrating the Healthcare Enterprise
IOD	Information Object Definition
JPEG	Joint Photographic Experts Group
MPPS	Modality Performed Procedure Step
MSPS	Modality Scheduled Procedure Step
MTU	Maximum Transmission Unit (IP)
MWL	Modality Worklist
NTP	Network Time Protocol
O	Optional (Key Attribute)
PACS	Picture Archiving and Communication System
PET	Positron Emission Tomography
R	Required (Key Attribute)
RIS	Radiology Information System
SC	Secondary Capture
SCP	Service Class Provider
SCU	Service Class User
SOP	Service-Object Pair
SR	Structured Reporting
TCP/IP	Transmission Control Protocol/Internet Protocol
U	Unique (Key Attribute)
VR	Value Representation

2 Network Conformance Statement

2.1 Introduction

This Conformance Statement (CS) specifies the GEHC CT compliance to DICOM. It details the DICOM Service Classes and roles that are supported by this product.

The GEHC CT product uses DICOM services to support the following functionalities:

- Import images for possible further analysis and/or processing
- Export images to other DICOM-compliant machines
- Confirm that a DICOM image has been permanently stored (archived) by a device
- Query for and display DICOM modality worklist information from a remote hospital or radiology department information systems
- Communicate Modality Performed Procedure Step to the Hospital/Radiology information systems
- Print images on DICOM Compliant Printers

2.2 Implementation Model

All DICOM functionality on the GEHC CT product is handled by the DICOM Server Application Entity (AE). The DICOM Server AE is commanded to perform DICOM services through the buttons and menu selections on the main user interface panel. The DICOM Server AE is also listening to a pre-defined port for incoming connections.

2.2.1 Application Data Flow Diagram

ILLUSTRATION 2-0
IMPLEMENTATION MODEL DATA FLOW DIAGRAM

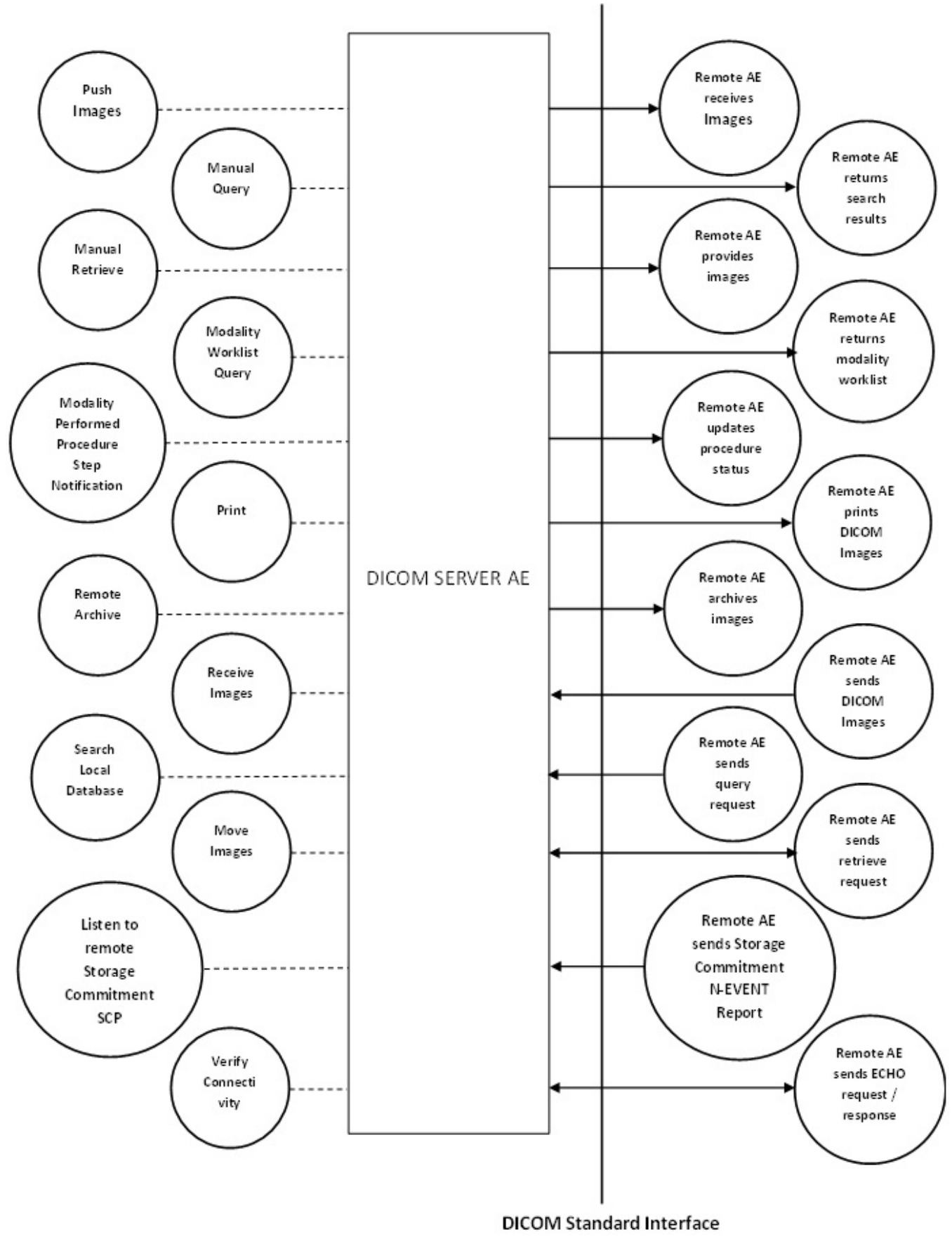

There are several Real-World Activities that will cause the DICOM Server Application Entity (DICOM Server AE) to initiate a DICOM association to a remote DICOM Application Entity. Illustration 2.0 above shows basic Real-World Activities.

The following paragraphs describe the Real-World Activities of Illustration 2.0:

- ***Push Images***

This Real-World Activity consists of an operator selecting one or more study, series or image in the local database manager and choosing either “Push Examination”, “Push Series” or “Push Image” from the “Network” pull-down menu on the local database manager to send the image(s) to a selected destination.

- ***Manual Query***

The operator queries one or a set of remote DICOM databases to obtain a list of data at Study/Series/Image level by clicking on the icon that represents the wanted remote DICOM AE.

- ***Manual Retrieve***

This Real-World activity will be available once the *Manual Query* activity is performed. The operator can now select one or more studies (series or images) and ask the DICOM Server AE to retrieve the selected image(s) from the Remote DICOM AE by clicking on the “Local DB” button at the bottom of the local database browser.

- ***Verify Connectivity (DICOM Ping)***

This Real-World activity consists of an operator selecting a Remote DICOM AE from the “Network Configuration” window and clicking on “Ping” on the right side-bar. This is to check the status of the selected remote DICOM AE.

- ***Remote Archive***

This Real-World activity consists of an operator choosing a remote DICOM AE that supports Storage Commitment as provider from the archive panel at the bottom of the local database browser. The operator chooses the exam or series in the local database browser and clicks on the archival destination from the archive list at the bottom of the local database browser.

The Commitment request for the transferred image instances is sent after the complete image transfer. The Commitment response can come on same association or on a different association. Refer to Section 5: **Storage Commitment Push Model Implementation** for details on the Storage Commitment implementation.

- ***Modality Worklist Query***

The operator or the system initiates a modality worklist query to the modality worklist SCP with a given set of query parameters. The modality worklist SCP returns responses matching the query parameters. Worklist items from the returned worklist query responses are presented to the user. The user then chooses the desired worklist item and begins the image acquisition process.

- ***Modality Performed Procedure Step Notification***

When the user begins the image acquisition process and generates the first image, the DICOM SERVER AE sends N-CREATE message to the configured MPPS SCP to indicate that the image

acquisition process has been started for the requested procedure.

The operator can close the acquisition session either by completing the acquisition process or discontinuing the ongoing scan. On closing the acquisition session, the DICOM SERVER AE sends N-SET message to the configured MPPS SCP to indicate the acquisition state of the requested procedure, with appropriate MPPS status (COMPLETED/DISCONTINUED).

- **Print**

The Film Composer allows the operator to select printers and it also allows the user to drag and drop the images (from viewer application) into the film. When user presses the "Print" Button, the DICOM SERVER AE tries to establish the association with requested printer and sends the images for printing.

- **Receive Images**

When remote DICOM hosts send DICOM images to DICOM SERVER AE, images are installed in the local database. The browser displays the content of the local database.

- **Image Installation**

The DICOM Server AE will perform this Real-World activity after the remote AE sends an image to the GEHC CT product.

- **Receive Verification request**

No operator action is required to respond to a verification message. The Real-World Activity associated with the verification request is to send a C-ECHO response message with a status of "success" to the requesting AE.

- **Search Local Database**

For this operation, a remote DICOM AE asks to obtain the list of data at Study/Series/Image level. Once a Query request is received, the DICOM Server AE will search the local database for all entries that match the keys requested by the Remote DICOM AE and send back the list of matches.

- **Move Images**

For this operation, a remote DICOM AE asks to send data at Study/Series/Image level from the local AE to another DICOM Remote AE. The Remote DICOM AE shall be declared locally on the system. The declaration of remote DICOM AE is done through a configuration tool.

- **Listen to remote Storage Commitment SCP**

The DICOM SERVER AE is indefinitely listening for association requests. No operator action is required to receive a Storage Commitment notification (N-EVENT-REPORT).

2.2.2 Functional Definition of AE's

DICOM Server Application Entity initiates the following operations:

- Initiate an association to a Remote AE for the purpose of sending images to the Remote AE.

Remote AE accepts the presentation context applicable to the image(s) being sent, the DICOM Server AE will send the image(s) to the receiving Remote AE by invoking the C-STORE-RQ operation for each image on the same association.

- Initiate an association to a Remote AE for the purpose of committing images previously sent successfully to the Remote AE for the purpose of the remote AE to commit to the storage of those images. If the Remote AE accepts the presentation context, a storage commitment will be established with the Remote AE with the DICOM Server AE sending the N-ACTION Request. The Remote AE completes the commitment by sending the N-EVENT REPORT. The DICOM Server AE updates the archive flag in the image browser for successful instances.
- Initiate an association with a Remote AE to query for images on the remote host. A Study-Root Study-Level C-FIND-RQ request will be sent to the Remote AE once an association has been established. Once all the responses have been received, the operator needs to select an exam in the local database browser. On selection of the exam the DICOM Server AE will issue a Series-Level C-FIND-RQ request to get the series for a study in the list. Similarly the Image-Level C-FIND-RQ will be issued for the series selected from the series list.
- Send a C-MOVE-RQ request to a Remote AE for retrieve of images after successful establishment. The DICOM Server AE's Storage SCP will receive the images over a separate association.
- Initiate an association with a Remote AE to verify its status with a C-ECHO-RQ. The Remote AE will report its status in a C-ECHO-RSP
- Initiate an association with a Remote AE to query for and display DICOM modality worklist information. Once the remote AE accepts the presentation context, CT system will issue a modality worklist query request using the C-FIND service
- Initiate an association with a Remote AE to create and update DICOM Modality Performed Procedure Step SOP instance in the remote AE. Once the remote AE accepts the presentation context, SOP instance is created using N-CREATE service and updated using N-SET service.
- Initiates as association with a remote printer for printing the images. If the Remote AE accepts the presentation context applicable to the print job, CT system will send the print job to the receiving remote AE.

The DICOM Server AE waits for association requests from Remote AEs that wish to perform the following operations:

- **Verification:** If a C-ECHO-RQ message is received, the DICOM Server AE will send back a C-ECHO-RSP message with a status of "success".
- **Image Storage:** If a C-STORE-RQ message is received, the DICOM Server AE will receive the image and try to update the local database. If the image is stored successfully on storage media and the database updated a status of "success" will be returned in a C-STORE-RSP message.
- **Query:** If a C-FIND-RQ message is received the DICOM Server AE will search the database for the requested attributes and send back a C-FIND-RSP message containing a match and a status of

“pending”. After all matching records have been sent, a status of “success” will be returned in a C-FIND-RSP message. The Remote AE can terminate the query by sending a C-CANCEL-FIND-RQ message.

- **Retrieve:** If a C-MOVE-RQ message is received the DICOM Server AE will look up its list of configured Remote AEs for the Destination AE. If the Destination AE is configured, the DICOM Server AE will open a new association to the Destination AE and use C-STORE-RQ to send the image(s). The DICOM Server AE will send a C-MOVE-RSP message with a status of “pending” after every five images are sent. When all images are sent or if DICOM Server AE receives a C-CANCEL-MOVE-RQ a final C-STORE-RSP will be sent back with an appropriate status.
- **Storage Commitment Response:** If a N-EVENT-REPORT request is received from the Remote Storage Commitment SCP the DICOM Server AE will update the Archive flag information for successful instances.

2.2.3 Sequencing of Real-World Activities

Real-World Activity *Query Remote* must be performed before *Choose Pull Option* can be performed.

2.3 AE Specifications

2.3.1 DICOM Server AE Specification

This Application Entity provides Standard Conformance to the following DICOM SOP Classes as an SCU:

SOP Class Name (SCU)	SOP Class UID
Verification (Echo)	1.2.840.10008.1.1
CT Image Information Storage	1.2.840.10008.5.1.4.1.1.2
MR Image Information Storage	1.2.840.10008.5.1.4.1.1.4
PET Image Information Storage	1.2.840.10008.5.1.4.1.1.128
RT Structure Set Storage	1.2.840.10008.5.1.4.1.1.481.3
Secondary Capture Image Storage	1.2.840.10008.5.1.4.1.1.7
Grayscale Softcopy Presentation State Storage	1.2.840.10008.5.1.4.1.1.11.1
X-Ray Radiation Dose SR Image Storage	1.2.840.10008.5.1.4.1.1.88.67
Enhanced SR Storage	1.2.840.10008.5.1.4.1.1.88.22
Study Root Query/Retrieve – FIND	1.2.840.10008.5.1.4.1.2.2.1
Study Root Query/Retrieve – MOVE	1.2.840.10008.5.1.4.1.2.2.2
Storage Commitment Push Model	1.2.840.10008.1.20.1
Basic Grayscale Print Management Meta SOP class	1.2.840.10008.5.1.1.9
Basic color print management meta SOP class	1.2.840.10008.5.1.1.18
Printer SOP Class	1.2.840.10008.5.1.1.16
Storage Commitment Push Model SOP	1.2.840.10008.1.20.1

Class	
Modality Performed Procedure Step SOP Class	1.2.840.10008.3.1.2.3.3
Basic Modality Worklist Information Model – FIND SOP Class	1.2.840.10008.5.1.4.31

Note: As to GSPS as an SCU, refer to Section 8: **Grayscale Softcopy Presentation State Implementation** for further details.

This Application Entity provides Standard Conformance to the following DICOM SOP classes as an SCP:

SOP Class Name (SCP)	SOP Class UID
Verification (Echo)	1.2.840.10008.1.1
CT Image Information Storage	1.2.840.10008.5.1.4.1.1.2
MR Image Information Storage	1.2.840.10008.5.1.4.1.1.4
PET Image Information Storage	1.2.840.10008.5.1.4.1.1.128
X-Ray Radiation Dose SR Image Storage	1.2.840.10008.5.1.4.1.1.88.67
RT Structure Set Storage	1.2.840.10008.5.1.4.1.1.481.3
Secondary Capture Image Storage	1.2.840.10008.5.1.4.1.1.7
Enhanced SR	1.2.840.10008.5.1.4.1.1.88.22
Study Root Query/Retrieve – FIND	1.2.840.10008.5.1.4.1.2.2.1
Study Root Query/Retrieve – MOVE	1.2.840.10008.5.1.4.1.2.2.2

2.3.1.1 Association Establishment Policy

2.3.1.1.1 General

The DICOM Application Context Name (ACN), which is always proposed, is:

Application Context Name	1.2.840.10008.3.1.1.1
---------------------------------	------------------------------

The Maximum Length PDU negotiation is included in all association establishment requests. The maximum length PDU for association initiated by the DICOM Server AE is:

Maximum Length PDU	64 Kbytes
---------------------------	------------------

SOP class Extended Negotiation is not supported.

The maximum number of Presentation Context Items that is supported is 60. Note that the same Abstract Syntax may be offered multiple times with different Transfer Syntax.

The user information items sent by this product are:

- Maximum PDU Length
- Implementation UID

The table in Appendix D identifies the Implementation UID for this product version.

2.3.1.1.2 Number of Associations

The DICOM Server AE (SCU) will initiate only one DICOM association at a time for each of the following services:

- Push image to a remote host
- Query/Retrieve
- Storage Commitment
- Modality Worklist
- PPS
- Print service

The DICOM Server AE (SCP) can have a maximum of four DICOM associations open simultaneously to Receive and Store image store, N-EVENT-REPORT of Storage Commitment or Respond to an Echo.

2.3.1.1.3 Asynchronous Nature

Asynchronous mode is not supported. All operations will be performed synchronously.

2.3.1.1.4 Implementation Identifying Information

The Implementation UID allows unique identification of a set of products that share the same implementation.

The table in Appendix D identifies the Implementation UID for this product version.

2.3.1.2 Association Initiation by Real-World Activity

2.3.1.2.1 Real World Activity: Push Option

2.3.1.2.1.1 Associated Real-World Activity

The operator must first select the exam/series/image on the local database browser and click on the Remote DICOM AE in the network panel at the bottom of the local database browser to which the operator desires to send the exam/series/image to.

Note: If multiple study, series, or images are chosen to be pushed, one association will be established for each of the studies, series, or images.

2.3.1.2.1.2 Proposed Presentation Contexts

The following table shows the proposed presentation contexts for the DICOM Server AE after Real-World Activity "Push Images" Operation has been performed.

Presentation Context Table – Proposal

Abstract Syntax		Transfer Syntax		Role	Extended Negotiation
Name	UID	Name List	UID List		
CT Image Storage	1.2.840.10008.5.1.4.1.1.2	Implicit VR Little Endian Explicit VR Little Endian Explicit VR Big Endian	1.2.840.10008.1.2 1.2.840.10008.1.2.1 1.2.840.10008.1.2.2	SCU	None
MR Image Storage	1.2.840.10008.5.1.4.1.1.4	Implicit VR Little Endian Explicit VR Little Endian Explicit VR Big Endian	1.2.840.10008.1.2 1.2.840.10008.1.2.1 1.2.840.10008.1.2.2	SCU	None
PET Image Storage	1.2.840.10008.5.1.4.1.1.128	Implicit VR Little Endian Explicit VR Little Endian Explicit VR Big Endian	1.2.840.10008.1.2 1.2.840.10008.1.2.1 1.2.840.10008.1.2.2	SCU	None
RT Structure Set Storage	1.2.840.10008.5.1.4.1.1.48 1.3	Implicit VR Little Endian Explicit VR Little Endian Explicit VR Big Endian	1.2.840.10008.1.2 1.2.840.10008.1.2.1 1.2.840.10008.1.2.2	SCU	None
Secondary Capture Image Storage	1.2.840.10008.5.1.4.1.1.17	Implicit VR Little Endian Explicit VR Little Endian Explicit VR Big Endian	1.2.840.10008.1.2 1.2.840.10008.1.2.1 1.2.840.10008.1.2.2	SCU	None
Grayscale Softcopy Presentation State Storage	1.2.840.10008.5.1.4.1.1.11 1	Implicit VR Little Endian Explicit VR Little Endian Explicit VR Big Endian	1.2.840.10008.1.2 1.2.840.10008.1.2.1 1.2.840.10008.1.2.2	SCU	None
Enhanced SR	1.2.840.10008.5.1.4.1.1.88.22	Implicit VR Little Endian Explicit VR Little Endian Explicit VR Big Endian	1.2.840.10008.1.2 1.2.840.10008.1.2.1 1.2.840.10008.1.2.2	SCU	None
X-Ray Radiation Dose SR	1.2.840.10008.5.1.4.1.1.88.67	Implicit VR Little Endian Explicit VR Little Endian Explicit VR Big Endian	1.2.840.10008.1.2 1.2.840.10008.1.2.1 1.2.840.10008.1.2.2	SCU	None

2.3.1.2.1.2.1 SOP Specific Conformance Statement for All Storage SOP Classes

This implementation can perform multiple C-STORE operations over a single association.

Upon receiving a C-STORE confirmation containing a successful status, this implementation will perform the next C-STORE operation. The association will be maintained if possible.

Upon receiving a C-STORE confirmation containing a Refused status, this implementation will terminate the association.

Upon receiving a C-STORE confirmation containing any status that is not Success or Warning, this implementation will consider the current request to be a failure and will terminate the association except if the C-STORE is invoked from a C-MOVE SCP. In this case it will continue to attempt to send the remaining images in the request on the same association.

Following are the status codes that are more specifically processed when receiving messages from Storage SCP equipment:

Service Status	Status Code	Further Meaning	Application Behavior When Receiving Status Code
Failure	A700-A7FF	Refused: Out of resources	Error displayed in the Network status and browser job manager queue.
	A900-A9FF	Error: Data Set does not match SOP Class	Error displayed in the Network status and browser job manager queue.
	C000-CFFF	Error: Cannot Understand	Error displayed in the Network status and browser job manager queue.
	0122	SOP Class Not Supported	Error displayed in the Network status and browser job manager queue.
Warning	B000	Coercion of Data Elements	Log-files updated
	B006	Elements Discarded	Log-files updated
	B007	Data Set does not match SOP Class	Log-files updated
Success	0000		Success status displayed in the Network status and browser job manager queue.
*	*	Any other status code	Treated as Failure

Each C-STORE operation supports an “Association Timer”. This timer starts when the association request is sent or received and stops when the association is established. The time-out is configurable in network-cfg.xml file as **StoreAssociationTimeout**. Default is 60 seconds.

Each C-STORE operation also supports an “Operation Inactivity Timer”. This time-out starts once the first C-STORE request has been issued (on association) or received and is reset each time a C-STORE response has been received or when subsequent C-STORES are sent. This time-out is configurable in networkcfg.xml file as **StoreResponseTimeout**. Default is 5 minutes.

If any of the two timers mentioned above expires, the connection is aborted and the operation is considered as failed.

Note: The time-outs are configurable.

When DICOM Server AE initiates an association to issue a C-STORE, the image will be transmitted by the DICOM Server AE with the same elements as was originally received or created locally (for the standard elements only).

2.3.1.2.1.2.2 SOP Specific Conformance Statement for Grayscale Softcopy Presentation State Storage SOP Class

To create Grayscale Softcopy Presentation State, there are 2 sequences in GEHC CT, Exam Split and Save State

2.3.1.2.1.2.2.1 Exam Split

The Exam Split feature supports two configuration modes of operation. If the other hospital systems support the IHE Radiology Presentation of Performed Procedures (PGP) Profile, the Exam Split feature should be configured as Virtual Exam Split. If the other hospital systems do not support the PGP profile, the Exam Split feature can be configured as Hard Exam Split. Both modes provide the user with the same user interface. The Hard Exam Split mode will create new image series with the images, which should be associated with a selected requested procedure.

This section of the DICOM Conformance Statement specifies the compliance to DICOM conformance requirements for the Grayscale Presentation State (GSPS), used in the Virtual Exam Split mode on this GEHC product. The Virtual Exam Split feature provides the DICOM Modality GSPS service as a service class user (SCU).

The Virtual Exam Split feature works in conjunction with the DICOM Modality Worklist feature and the Modality Performed Procedure Step feature to support the IHE PGP profile as an acquisition modality.

2.3.1.2.1.2.2.1.1 Implementation Model

Virtual Exam Split will create Grayscale Presentation State (GSPS) and Performed Presentation State as defined for the Modality actor in the IHE Radiology Presentation of Grouped Procedures (PGP) Profile.

2.3.1.2.1.2.2.1.2 Application Data Flow Diagram

The basic Application models for the feature are shown in the following illustration:

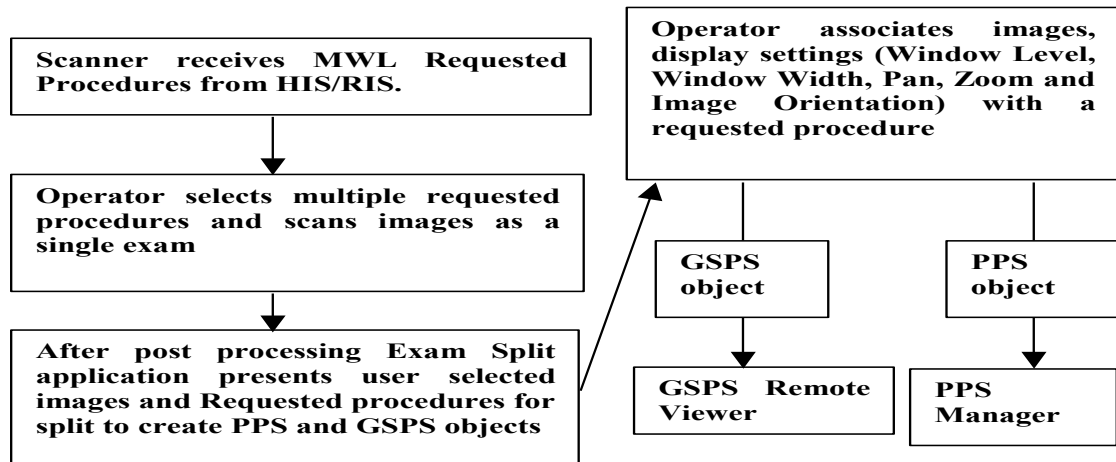

2.3.1.2.1.2.2.1.3 GSPS Acquisition System with MWL data

The system has a Modality Worklist Server AE installed. Worklist information is obtained from HIS/RIS system through the use of Basic Worklist Management Service. Use of the information retrieved in the creation of Image SOP instance is described in the Modality Worklist Conformance statement. Use of the information retrieved in MPPS SOP instances is described later in this document.

- After Post processing Exam Split application presents associated requested Procedure(s) along with selected acquired Images.
- Exam Split application includes the necessary information related to Requested Procedure, scheduled Procedure Steps and the Performed Procedure Step of the images acquired during acquisition.
- After User modifications on Image(s), user has to click on Send button to create Grayscale Presentation State and Performed Procedure Step objects to transmit to remote host. If there is any Image Orientation, user will be notified about the orientation before sending to Remote Host.
- Exam Split will provide Host Selection user interface to select remote host to transmit of Grayscale Presentation State object. Performed Procedure Step object will be sent to default Performed Procedure Step host.
- After successful transmission of Grayscale Presentation State and Performed Procedure Step objects to remote host, user will be notified with success.

2.3.1.2.1.2.2.2 Save State

2.3.1.2.1.2.2.2.1 Implementation Model

Save State will create Grayscale Presentation State (GSPS) including user annotation.

2.3.1.2.1.2.2.2.2 Application Data Flow Diagram

The basic Application models for the feature are shown in the following illustration:

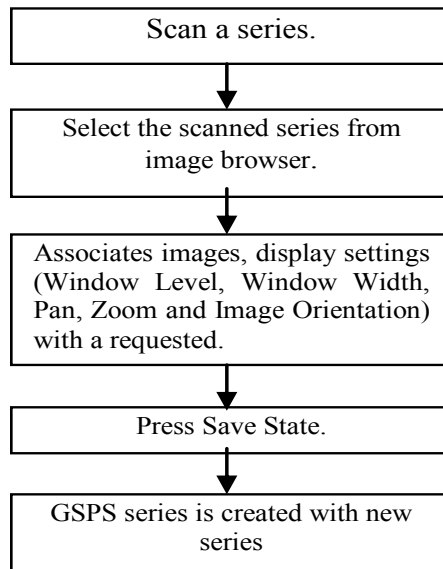

2.3.1.2.1.2.2.3 GSPS Acquisition System with MWL data

- Operator takes some scans. After the scan finished, images shall be selected from image browser and select Viewer.
- Operator adds annotation or ROI on images, change WW or WL, zoom or roam images.
- After changing settings, operator shall select "Save State" on Viewer menu. Then, GSPS object shall be created with a new series number.

2.3.1.2.2 Real World Activity: Manual Query

2.3.1.2.2.1 Associated Real-World Activity

The operator must select the Remote DICOM AE from the "Source" pull-down on the local database browser and select the hostname of the source from where the images are to be retrieved.

Provided that the operator had set "Custom search" to "Off" when setting the Remote host parameters, the "Query" operation will cause the DICOM Server AE to initiate an association (with zero length Patient name, Patient id, Study date, Accession number, and Study id) to the selected Remote AE when the "Hostname" entry is selected from the "Source" pull-down menu.

Otherwise, if the operator had set "Custom search" to "On" when setting the Remote host parameters, the "Query" operation will cause a *Customize search parameters* menu to appear. The operator can enter values for Patient name, Patient id, Study date, Accession number, and Study id. Not entering a value means match on any value for that field. Patient name will match on any patient name that contains what the operator entered. Patient id, Study id, and Accession number will match on what the operator enters.

For Study date, the operator selects a range type from the "Exam Date" pull down menu, where the choices are "Equals", "Before", "Between", or "After". Once a range type is selected, the correct number of fields appears and the operator enters dates into those fields. Once the desired parameters are entered the operator chooses "OK" and that will cause the DICOM Server AE to initiate an association to the selected Remote AE.

Once a list of Study/Series/Image is retrieved, the operator can invoke the “Pull” operation by clicking on the “Local DB” button at the bottom of the local database browser.

2.3.1.2.2.2 Proposed Presentation Contexts

When the Real-World activity “Manual Query” is initiated all presentation contexts shown in the following table are proposed during association establishment, but only the Query/Retrieve-FIND related contexts are applicable to this activity.

Presentation Context Table – Proposal					
Abstract Syntax		Transfer Syntax		Role	Extended Negotiation
Name	UID	Name List	UID List		
Study Root Query/Retrieve FIND	1.2.840.10008.5.1.4.1.2.2.1	Implicit VR Little Endian	1.2.840.10008.1.2	SCU	None
		Explicit VR Little Endian	1.2.840.10008.1.2.1		
		Explicit VR Big Endian	1.2.840.10008.1.2.2		
Study Root Query/Retrieve MOVE	1.2.840.10008.5.1.4.1.2.2.2	Implicit VR Little Endian	1.2.840.10008.1.2	SCU	None
		Explicit VR Little Endian	1.2.840.10008.1.2.1		
		Explicit VR Big Endian	1.2.840.10008.1.2.2		

When the Real-World activity “Manual Query” is initiated all presentation contexts shown in the table above are proposed during association establishment, but only the Query/Retrieve-FIND related contexts are applicable to this activity.

2.3.1.2.2.2.1 SOP Specific Conformance Statement for C-FIND SCU

After the Query operation is initiated, the DICOM Server AE will perform a study-root C-FIND-RQ request at each of the three levels (Study, Series, and Image) in succession.

The Initial Study-Level request will ask for all studies in the Remote database that match the user specified Patient name, Patient Id, Study ID, Accession number, and Study Date. Zero length data in any of those fields means match on any value. Zero length data is the default value if the user does not specify a value.

The user specified Patient name will come surrounded by single asterisks (asterisk is a wild card that matches any number of characters).

Caret (“^”) character cannot be used as a separator of Last name and First name.

The Study date is a range of dates where a *date* is exactly 8 characters long and the format of the range is:

- "" is any date,
- "yyyymmdd-" is any date on or after that year/month/day,
- "-yyyymmdd" is any date on or before that year/month/day,
- "yyyymmdd-yyyymmdd" is any date on or between those dates,

- "yyyymmdd" is only on that date.

The C-FIND SCU will not perform any extended negotiation and so will only perform hierarchical query. Relational Queries are not supported.

Each C-FIND SCU operation supports an "Association Timer" and "Operation Inactivity Timer" using **QueryAssociationTimeout** and **QueryResponseTimeout**, in network-cfg.xml configuration file. Default values are 30 seconds, 5 minutes respectively.

The user can cancel the current C-FIND request by changing the source listing to Local DB or any other remote host. If a query operation is in progress, the DICOM SERVER AE will issue a C-FIND-CANCEL message to the remote AE to discontinue the ongoing C-FIND operation.

If a "Cancel" or "Refused" status is returned from the Remote AE the association is closed and the operation terminated.

The user can cancel the C-FIND request by moving to another network node or clicking on the local database.

The DICOM Server AE will parse each matching C-FIND-RSP reply and ignore the entries that do not contain a valid DICOM data stream. No VR validation is performed which means that syntax errors will be ignored. Tables 2.3.1.2.2.2.1-2 - 2.3.1.2.2.2.1-4 shows the various fields that are requested at the Study, Series, and Image levels of the C-FIND request.

Query results are filtered based on the Modality field. Only CT/MR Screen Save images are supported.

During the C-FIND, the following status values are supported:

- 0xFF00: Study/Series/Image items contained in identifier is collected for later display or further processing and wait for the next response from the remote host.
- 0xFF01: Study/Series/Image items contained in identifier is collected for later display or further processing and wait for the next response from the remote host.

The status codes that are more specifically processed when receiving messages from Query SCP equipment is described in Table 2.3.1.2.2.2.1-1.

Table 2.3.1.2.2.1-1 C-FIND Response Status Values

Service Status	Status Code	Further Meaning	Application Behavior When Receiving Status Code
Failure	A700	Refused: Out of resources	Browser displays appropriate error to user
	A900	Error: Identifier does not match SOP Class	Browser displays appropriate error to user
	C000-CFFF	Error: Unable to process	Browser displays appropriate error to user
Cancel	FE00	Matching terminated due to cancel	Processed and gracefully exits C-FIND request processing
Success	0000	Matching is complete - No final identifier is supplied	Processed and gracefully exits C-FIND request processing
Pending	FF00	Matches are continuing - Current Match is supplied and any Optional Keys were supported in the same manner as Required Keys.	Processed and the data is displayed in the Browser
	FF01	Matches are continuing - Warning that one or more Optional Keys were not supported for existence for this Identifier	Processed and the data is displayed in the Browser
*	*	Any other status code.	Treated as Failure

The DICOM Server AE will parse each matching C-FIND-RSP reply and ignore the entries it fails to parse. Tables 2.3.1.2.2.2.1-2 - 2.3.1.2.2.2.1-4 shows the various fields that are requested at the Study, Series, and Image levels of the C-FIND request.

Query results are filtered based on the Modality field. Only CT/MR Screen Save images are supported.

Table 2.3.1.2.2.2.1-2: Requested Study Level Keys

Description	Type	Tag	Value
Study date	R	0008,0020	Zero length for any Study date, or "yyyymmdd-yyyymmdd" matches inclusive range of 'from-to' Study dates. 'From' or 'To' date can be zero length meaning that side of the range is any date.
Study time	R	0008,0030	Zero length

Description	Type	Tag	Value
Accession number	R	0008,0050	Zero length for any Accession number, or Accession number matches this value
Patient's name	R	0010,0010	Zero length for any Patient name, or Patient's name matches this value
Patient ID	R	0010,0020	Zero length for any Patient id, or Patient id matches this value
Study id	R	0020,0010	Zero length for any Study id, or Study id matches this value
Study Instance UID	U	0020,000D	Zero length for Study level query. Study Instance UID of study for which matches are requested at a lower level
Study description	O	0008,1030	Zero length
Private Creator Identification	P	0009,00xx	GEMS_IDEN_01
Suite Id	P	0009,xx02	Zero Length

Table 2.3.1.2.2.1-3: Requested Series Level Keys

Description	Type	Tag	Value
Modality	R	0008,0060	Zero length
Series number	R	0020,0011	Zero length
Series Instance UID	U	0020,000E	Zero length for Series level query. Series instance UID of series for which matches are requested at a lower level
Series description	O	0008,103E	Zero length
Manufacturer	O	0008,0070	Zero length
Images in series	O	0020,1002	Zero length

Table 2.3.1.2.2.1-4: Requested Image Level Keys

Description	Type	Tag	Value
Image number	R	0020,0013	Zero length
Image Instance UID	U	0008,0018	Zero length
Image type	O	0008,0008	Zero length
Rows	O	0028,0010	Zero length
Columns	O	0028,0011	Zero length

Description	Type	Tag	Value
Image position	O	0020,0032	Zero length
Image orientation	O	0020,0037	Zero length
Slice thickness	O	0018,0050	Zero length
Slice spacing	O	0018,0088	Zero length
Gantry tilt	O	0018,1120	Zero length
Convolution kernel	O	0018,1210	Zero length
Reconstruction diameter	O	0018,1100	Zero length
Data collection diameter	O	0018,0090	Zero length
Flip angle	O	0018,1314	Zero length
Echo number	O	0018,0086	Zero length
Echo time	O	0018,0081	Zero length
Inversion time	O	0018,0082	Zero length
Repetition time	O	0018,0080	Zero length
Private Creator Identification	P	0019,00xx	GEMS_ACQU_01
Dfov Rect	P	0019,xx1E	Zero Length
Midscan Time	P	0019,xx24	Zero Length
Azimuth	P	0019,xx26	Zero Length
Number of Echo	P	0019,xx7E	Zero Length
Private Creator Identification	P	0021,00xx	GEMS_RELAX_01
Scout Anref	P	0021,xx4A	Zero Length
Private Creator Identification	P	0027,00xx	GEMS_IMAG_01
Location RAS	P	0027,xx40	Zero Length
Location	P	0027,xx41	Zero Length
Center R Coordinate	P	0027,xx42	Zero Length
Center A Coordinate	P	0027,xx43	Zero Length
Table Start Location	P	0027,xx50	Zero Length
Table End Location	P	0027,xx51	Zero Length
RAS Letter for Side of Image	P	0027,xx52	Zero Length
RAS Letter for Anterior/Posterior	P	0027,xx53	Zero Length
RAS Letter for Scout Start Location	P	0027,xx54	Zero Length
RAS Letter for Scout End Location	P	0027,xx55	Zero Length
Image Dimension X	P	0027,xx60	Zero Length
Image Dimension Y	P	0027,xx61	Zero Length

Note1: Refer to section 2.3.1.2.2.1 for Custom Search/Query option.

Note2: Type P refers to a private DICOM element.

2.3.1.2.3 Real World Activity: Manual Retrieve

2.3.1.2.3.1 Associated Real-World Activity

The operator must select the Remote DICOM AE from the "Source" pull-down on the local database

browser and select the hostname of the source from where the images are to be retrieved. Once a list of Study/Series/Image is retrieved, the operator can invoke the “Retrieve” operation by clicking on the “Local DB” button at the bottom of the local database browser.

2.3.1.2.3.2 Proposed Presentation Contexts

When the Real-World activity “Manual Retrieve” is initiated all presentation contexts shown in the following table are proposed during association establishment, but only the Query/Retrieve-MOVE related contexts are applicable to this activity.

Presentation Context Table – Proposal					
Abstract Syntax		Transfer Syntax		Role	Extended Negotiation
Name	UID	Name List	UID List		
Study Root Query/Retrieve MOVE	1.2.840.10008.5.1.4.1.2.2.2	Implicit VR Little Endian	1.2.840.10008.1.2	SCU	None
Study Root Query/Retrieve FIND	1.2.840.10008.5.1.4.1.2.2.1	Implicit VR Little Endian	1.2.840.10008.1.2	SCU	None

2.3.1.2.3.2.1 SOP Specific Conformance Statement for C-MOVE SCU

When the operator starts a *Move* operation at any level (Study, Series, Image) the DICOM Server AE will initiate a C-MOVE-RQ request with UIDs at the appropriate level (Study, Series, Image) to the Remote AE with the DICOM Server AE as the Destination AE. The Storage SCP (“Receive Images”) will handle the incoming images as described in section 2.3.1.3.1.

C-MOVE supports list of Studies (through list of Study UIDs), list of Series (through list of Series UIDs) and list of Images (through list of Instances UIDs).

Each C-MOVE SCU operation supports an “Association Timer” and “Operation Inactivity Timer” with time out values of 30 seconds and 15 seconds respectively.

If the C-MOVE SCU receives a status different from success (0x0000) or pending (0xFF00) during the association, the DICOM SERVER AE will release the association. This information will be logged in the system log files and the network queue will be updated accordingly.

During Manual Retrieve, the DICOM SERVER AE is able to generate a C-MOVE-CANCEL if the operator Pauses or Deletes the retrieve job.

When receiving a Cancel request response (0xFE00), the DICOM SERVER AE will release the association. This information will be logged in the system log files and the network queue will be updated accordingly.

Following are the status codes that are more specifically processed when receiving messages from Retrieve SCP equipment:

Service Status	Status Code	Further Meaning	Application Behavior When Receiving Status Code
Failure	A701	Refused: Out of resources - Unable to calculate number of matches	System will display the message in job manager user interface and retry the operation after configured time is elapsed.
	A702	Refused: Out of resources - Unable to perform sub-operations	System will log the message and retry the operation after configured time is elapsed.
	A801	Refused: Move Destination Unknown	System will display the message in job manager user interface.
	A900	Error: Identifier does not match SOP Class	System will display the message in job manager user interface.
	C000-CFFF	Error: Unable to process	System will display the message in job manager user interface.
Cancel	FE00	Sub-operations terminated due to a Cancel indication	Operation will be terminated and the system will display the message in job manager user interface.
Warning	B000	Sub-operations Complete - One or more Failures.	System will log the information.
Success	0000	Sub-operations Complete - No Failure.	Processed and gracefully exits C-MOVE request processing
Pending	FF00	Sub-operations are continuing -	System processes the information and displays the progress in the job manager UI
*	*	Any other status code.	Treated as Failure

The DICOM Server AE will send a C-CANCEL-MOVE-RQ to the Remote AE if the operator “Pauses” or “Clears” the job from the local database manager Network queue

2.3.1.2.4 Real-World Activity: Verify (DICOM Ping)

2.3.1.2.4.1 Associated Real-World Activity

The operator shall select a Remote DICOM AE from the “Network Configuration” window and click on “Ping” on the right side-bar. The DICOM server will initiate an association with the remote DICOM AE

in order to verify communication at the application level. The success or failure of the verification process is displayed to the user.

If the C-ECHO response is received with a success, the DICOM Server will post a pop-up to the operator indicating that the remote device is alive

2.3.1.2.4.2 Proposed Presentation Context Table

Refer to the following table for the Proposed Presentation Contexts for DICOM Server AE and Real-World activity Verification

Presentation Context Table – Proposal					
Abstract Syntax		Transfer Syntax		Role	Extended Negotiation
Name	UID	Name List	UID List		
Verification	1.2.840.10008.1.1	Implicit VR Little Endian	1.2.840.10008.1.2	SCU	None

2.3.1.2.4.2.1 SOP Specific DICOM Conformance C_ECHO SCU

The GEHC CT DICOM Server AE provides standard conformance to the DICOM Verification Service Class.

Each ECHO operation supports “Association Timer” with **EchoAssociationTimeout**, in network-cfg.xml configuration file. Default values are 20 seconds.

Upon receiving a C-ECHO-RSP, containing a successful status, a message will be posted to the operator indicating success

2.3.1.2.5 Real-World Activity: Remote Archive

2.3.1.2.5.1 Associated Real-World Activity – “Choose Archive Save Option”

The operator must first set remote hosts from Network Configuration from “Tools” pull-down menu. If the remote node is already present, select one remote host, click “Edit” on the right side-bar and make a check on “Archive Node” check box. If the remote host is not present, add the remote host with check on “Archive Node” check box.

Note: The remote node should be a Storage Commitment SCP. STC AE Title can be different from STORE AE title.

The user selects the exam/series to be committed and click on the archival destination from the archive list at the bottom of the local database browser. All the images currently in the selected exam/series will be sent to the selected remote archive node (which is also the Storage commitment

SCP) using DICOM C-STORE operations. Just after all the images are transferred the commitment request will be sent on a separate association.

2.3.1.2.5.2 Associated Real-World Activity – “Auto Archive exam/series”

The Auto archive API’s are used to archive the exams/series onto local archive media or the remote archive node (which shall be a Storage Commitment SCP) without manual interface. If the default device selected for Auto Archive is a remote Storage Commitment SCP then all the images currently in the specified exam/series will be sent to the selected Storage commitment SCP using C-STORE operations. Just after successful transfer of all the images the Storage Commitment request will be sent.

2.3.1.2.5.3 Proposed Presentation Context

The Proposed Presentation Context table for the DICOM Storage Commitment SCU is as shown in following Table.

Presentation Context Table					
Abstract Syntax		Transfer Syntax		Role	Extended
Name	UID	Name	UID		Negotiation
Storage Commitment Push Model SOP Class	1.2.840.10008.1.2.0.1	Implicit VR Little Endian	1.2.840.10008.1.2	SCU	None
		Explicit VR Little Endian	1.2.840.10008.1.2.1		
		Explicit VR Big Endian	1.2.840.10008.1.2.2		

2.3.1.2.5.3.1 SOP Specific DICOM Conformance Statement for the Storage Commitment Push Model SOP Class SCU (N-ACTION)

The Storage Commitment SCU can send the commitment request for following SOP classes.

NAME	UID
CT Image Storage SOP Class	1.2.840.10008.5.1.4.1.1.2
MR Image storage SOP Class	1.2.840.10008.5.1.4.1.1.4
PET Image Information Storage	1.2.840.10008.5.1.4.1.1.128
RT Structure Set Storage	1.2.840.10008.5.1.4.1.1.481.3
Secondary Capture Storage SOP Class	1.2.840.10008.5.1.4.1.1.7
Grayscale Softcopy Presentation State Storage SOP Class	1.2.840.10008.5.1.4.1.1.11.1
Enhanced SR	1.2.840.10008.5.1.4.1.1.88.22
X-Ray Radiation Dose SR	1.2.840.10008.5.1.4.1.1.88.67

The images in the selected exam/series are sent to the remote commitment provider entity using DICOM C-STORE operations. If there are any failures in the image transfers the Storage commitment request will not be sent. The corresponding job will be marked as failed and user will be notified of the status of job.

If all the images are successfully transferred then the commitment request will be sent on a different association with the list of SOP instances.

If the N-Action request fails, the job will be marked as failed otherwise following sequence of actions will take place.

The SCU waits for N_ACTION response from the provider on the same association for a configurable amount of time. Default time-out is 600 seconds. If it does not receive N_ACTION response during this time it closes the association and marks the job as failed.

If the received N-ACTION Response from the Storage Commitment Provider has a success status, the DICOM SERVER AE waits 10 seconds for an N-EVENT-REPORT on the same association. This time-out is not configurable. If the N-EVENT-REPORT request is not received in this time, it closes the association and changes the Job state to "Waiting" indicating the job is waiting for the response from commitment provider.

The DICOM SERVER AE can receive N-EVENT-REPORT from the Storage Commitment Provider at any time (See section 2.3.1.3.5 - Real-World Activity: Listen to remote Storage Commitment SCP").

A New transaction UID will be created for each retry by user. The old transaction uid is not applicable for these requests.

2.3.1.2.5.3.2 Storage Commitment Push Model SOP Class Request processing

The following DIMSE service Elements are supported for the Storage Commitment request processing.

N-ACTION – Requests the remote Storage Commitment SCP to commit to storing the image instances.

The following attributes are sent as part of the DATA Set for the N-ACTION request.

Attribute	Tag	Value
Transaction UID	(0008,1195)	Transaction UID
Referenced SOP Sequence	(0008,1199)	
SOP Class UID	(0008,1150)	
SOP Instance UID	(0008,1155)	

- Referenced Study Component sequence attribute is not sent.
- Storage Media File-Set ID and Storage Media File-Set UID attributes are not supported.

2.3.1.2.5.3.3 Storage Commitment Push Model SOP Class Response processing

The following DIMSE Service Elements are supported for the Storage Commitment response processing.

N-EVENT-REPORT – The Response sent by the remote Storage Commitment SCP.

Once the N-EVENT REPORT is received, the following actions will be taken depending on the status of the response

2.3.1.2.5.3.3.1 Commit response with SUCCESS status

The Archive flag information in the browser for all the successful instances will be updated. The status will be changed to “Y”.

The job queue entry will be removed

Note: The following attributes are expected as part of DATA Set for N-EVENT-REPORT from SCP

Attribute	Tag	Value
Transaction UID	(0008,1195)	Value received from SCP
Referenced SOP Sequence	(0008,1199)	Value received from SCP
SOP Class UID	(0008,1150)	Value received from SCP
SOP Instance UID	(0008,1155)	Value received from SCP

N-EVENT-REPORT-RSP will be sent on the same association itself. No DATA Set will be sent along with the response.

2.3.1.2.5.3.3.2 Commit response with FAILURE status

The following attributes are expected as part of DATA Set for N-EVENT-REPORT from SCP:

Attribute	Tag	Value
Transaction UID	(0008,1195)	Value received from SCP
Failed SOP Sequence	(0008,1198)	Value received from SCP
SOP Class UID	(0008,1150)	Value received from SCP
SOP Instance UID	(0008,1155)	Value received from SCP
Failure Reason	(0008,1197)	Value received from SCP

In case of complete/partial failure the user will be notified about the status and the job entry will be paused. There is no attempt made to retry automatically the failed SOP instances. However the user can manually retry the failed jobs. Such requests will be treated as new requests. This will go through the whole sequence of operations once again.

The failure reason is ignored.

Failed SOP instances will have their archive flag information unaltered.

Note: The archive status flag in the browser is a shared flag with local archive. When the status is "Y", it means that the images are archived but doesn't specify whether on local archive device or remote archive device. It is left to the user's discretion whether the local SOP instances (with their archive flag set to "Y") are to be deleted.

N-EVENT-RESPONSE will be sent on the same association itself. No DATA Set will be sent along with the response.

Note: (0008, 1199) Reference SOP Sequence is not handled.

Refer **Section.5 Storage Commitment Push Model Implementation.**

2.3.1.2.6 Real-World Activity: Modality Worklist Query

2.3.1.2.6.1 Associated Real-World Activity

The operator of the system initiates a query for a modality worklist by either opening the Schedule screen or by opening the Schedule screen and pressing the Update button. The choice of which of these two behaviors occurs is user configurable. The Worklist Server will then initiate an association with the remote AE in order to query for the worklist

A user can configure a number of parameters that directly control the worklist query request. The user can request worklist items that are intended for the scanner the user is working at, all items that apply to the modality of the scanner the user is working at or all worklist items available. These selections and their effects on worklist query parameters are given below:

This System:

- Modality, (0008,0060) - set to CT
- Scheduled Station AE Title, (0040,0001) - set to local AE title

All CT Systems:

- Modality, (0008,0060) - set to CT
- Scheduled Station AE Title, (0040,0001) - zero-length (universal matching)

All Systems

- Modality, (0008,0060) - zero-length (universal matching)
- Scheduled Station AE Title, (0040,0001) - zero-length (universal matching)

The scheduled dates of procedures of interest can be specified for query by selecting a specific date range. The date ranges available are Today, Days Before Today, Days After Today and AllDates. These selections and their effects on worklist query parameters are given below:

Today:

Scheduled Procedure Step Start Date (0040,0002) - set to YYYYMMDD, where this date is the current date.

Days Before Today and Days After Today: Scheduled Procedure Step Start Date (0040,0002) - set to YYYYMMDD-YYYYMMDD, where this date range represents the specified number of days before today and/or after today. Note that number of days both before and after can be specified in the same query and that each always includes today.

All Dates: Scheduled Procedure Step Start Date (0040,0002) - zero-length (universal matching)

The system also supports a Custom Query option where the user can filter based on Patient Name, Patient ID, Accession Number or Requested Procedure Step ID using a User Interface.

Refer sec 6.5.2 Setting Custom Query Option

2.3.1.2.6.2 Proposed Presentation Context

Below table shows the proposed presentation contexts for the DICOM SERVER AE after real-world activity "Modality Worklist Query" has been initiated:

Presentation Context Table – Proposed by DICOM SERVER AE for Activity Modality Worklist Query					
Abstract Syntax		Transfer Syntax		Role	Extended Negotiation
Name	UID	Name List	UID List		
Modality Worklist Information Model – FIND	1.2.840.10008.5.1.4.31	Implicit VR Little Endian	1.2.840.10008.1.2	SCU	None
		Explicit VR Little Endian	1.2.840.10008.1.2.1		
		Explicit VR Big Endian	1.2.840.10008.1.2.2		

2.3.1.2.6.2.1 SOP Specific DICOM Conformance Statement for the Modality Worklist Information Model FIND SOP Class

If the remote AE does not support the proposed Presentation Context, an appropriate error is logged and the operator is notified.

This implementation can receive multiple C-FIND results over a single association. Only one association is opened at a time.

Each C-FIND response received from the remote AE is parsed to verify the length/type of the items in the response. Upon detecting any error in the response data, the response is discarded and the next response (if any) is considered.

Each C-FIND SCU operation supports an "Association Timer" and "Operation Inactivity Timer" using QueryAssociationTimeout and QueryResponseTimeout configuration parameters. Default values are 30 seconds, 5 minutes respectively.

All errors and failures detected by the DICOM SERVER AE are logged to the service log files.

In case of ERROR, persisted worklist item(s) got from previous request to the configured SCP would be shown.

User can cancel the ongoing worklist query by clicking on the Cancel button in the UI. Upon cancel, the DICOM SERVER AE will send C-FIND-CANCEL request to the Modality Worklist SCP.

Following are the status codes that are more specifically processed when receiving messages from a **Modality Worklist** SCP equipment :

Service Status	Status Code	Further Meaning	Application Behavior When Receiving Status Code
Failure	A700	Refused: Out of resources	Logs the error and displays all the persisted worklists
	A900	Error: Identifier does not match SOP Class	Logs the error and displays all the persisted worklists
	C001	Error: Unable to process	Logs the error and displays all the persisted worklists
Cancel	FE00	Matching terminated due to cancel	Closes the association
Success	0000	Matching is complete - No final identifier is supplied	Displays all the worklists items obtained from the SCP
Pending	FF00	Matches are continuing - Current Match is supplied and any Optional Keys were supported in the same manner as Required Keys.	Continue to wait for worklists items from SCP
*	FF01	Matches are continuing - Warning that one or more Optional Keys were not supported for existence for this Identifier	Continue to wait for worklists items from SCP
	*	Any other status code.	Worklist query operation is considered as failure and the error message is displayed to the user. Persisted worklist item(s) got from previous request to the SCP will be shown

2.3.1.2.6.2.2 Record Acceptance Policy

The GEHC CT implementation adheres to strict value checking of incoming query responses from the remote AE. Each response received is examined to verify that all Type 1 attributes are present with non-zero length, that all Type 2 attributes are present (possibly with zero length) and that the data for all attributes is consistent with respect to the attributes' value representation (VR).

Any inconsistencies in the response data, with respect to the categories described above, are considered errors. Upon detecting any such errors in the response data, the Worklist Server AE will issue a C-FIND-CANCEL and, upon receipt of a C-FIND-RSP (or if an applicable timer expires), will abort the association. All previously received worklist items are retained. Note that the absence of requested Type 3 attributes is not considered an error.

Fields considered Type 1 by the Worklist Server include:

- (0010,0010), Patient Name
- (0010,0020), Patient ID
- (0020,000D), Study Instance UID
- (0040,0001), Scheduled Station AE Title
- (0040,0002), Scheduled Procedure Step Start Date ¹
- (0040,0003), Scheduled Procedure Step Start Time ¹
- (0040,0009), Scheduled Procedure Step ID
- (0040,1001), Requested Procedure ID

¹ Start Date must be of the form YYYYMMDD, exactly eight numeric characters, and Start Time must be of the form HHMMSS, exactly six numeric characters.

Fields considered Type 2 by Worklist Server include:

- (0008,0050), Accession Number
- (0008,0060), Modality
- (0008,0090), Referring Physician Name
- (0010,0030), Patient Date of Birth
- (0010,0040), Patient Sex
- (0010,1030), Patient Weight in kg
- (0010,2000), Medical Alerts
- (0010,2110), Contrast Allergies
- (0010,21C0), Pregnancy Status
- (0032,1032), Requesting Physician
- (0032,1070), Requested Contrast Agent
- (0038,0010), Admission ID
- (0038,0050), Special Needs
- (0038,0300), Current Patient Location
- (0038,0500), Patient State
- (0040,0006), Performing Physician
- (0040,0010), Scheduled Station Name
- (0040,0011), Scheduled Procedure Step Location
- (0040,0012), Pre-order Medication
- (0040,1003), Requested Procedure Priority
- (0040,1004), Patient Transport Arrangements
- (0040,3001), Confidentiality Constraint

Refer **Section.6 Modality Worklist Query Implementation.**

2.3.1.2.7 Real-World Activity: Modality Performed Procedure Step Notification

The PPS Server AE is implemented as an application process on the scanner host computer. It runs as a daemon serving requests from other applications to send the PPS information to the remote AE and return the results to the requesting application.

The PPS Server AE initiates the following functions.

- **Start PPS:** Initiates a DICOM association in order to create a DICOM Modality Performed Procedure Step SOP instance in the remote AE. If the remote AE accepts a presentation context applicable to Modality performed Procedure Step, the PPS Server AE will issue a request to create the SOP instance in the remote AE via the N-CREATE service.
- **Complete PPS:** Initiates a DICOM association in order to update a DICOM Modality Performed Step instance that is already created with the remote AE. If the remote AE accepts a presentation context applicable to Modality performed Procedure Step, the PPS Server AE will issue a request to update the SOP instance in the remote AE via the N-SET service. The PPS Status is set to 'COMPLETED'.
- **Discontinue PPS:** Initiates a DICOM association in order to update a DICOM Modality Performed Step instance that is already created with the remote AE. If the remote AE accepts a presentation context applicable to Modality performed Procedure Step, the PPS Server AE will issue a request to update the SOP instance in the remote AE via the N-SET service. The PPS Status is set to 'DISCONTINUED'

2.3.1.2.7.1 Associated Real-World Activity

The real-world activities are described in the following sections. Each of the real world activity results in either creating a new Performed Procedure Step SOP instance at the remote SCP or updating an already created Performed Procedure Step SOP instance as per the DICOM standard.

2.3.1.2.7.1.1 Sequencing of Real-World Activities

2.3.1.2.7.1.1.1 PPS from Acquisition System with MWL data

The system has a Modality Worklist Server AE installed. Worklist information is obtained from HIS/RIS system through the use of Basic Worklist Management Service. Use of the information retrieved in the creation of Image SOP instance is described in the Modality Worklist Conformance statement. Use of the information retrieved in MPPS SOP instances is described later in this document.

- The system initiates a 'Start PPS' after the first image is acquired into the database. The system retrieves necessary information related to the Scheduled Procedure Step from Modality Worklist Server. PPS Server AE initiates a MPPS (Modality Performed Procedure Step) N-CREATE request to the remote AE (MPPS SCP), in-order to create a MPPS SOP instance at the remote AE.
- The MPPS SCP returns response indicating the success/failure of the request execution. The PPS state information is updated in the system based on the response data, and is presented to the user. **The DICOM association is closed.**

- System includes the necessary information related to Scheduled Procedure Steps and the Performed procedure Step in the image instances created.
- At the end of image acquisition, system initiates a 'Complete PPS' or 'Discontinue PPS' based on the choice selected by the user using the user interface provided. The user is also given a choice 'Defer PPS' which is described below. PPS Server AE initiates a MPPS N-SET request to the remote AE, in-order to update the MPPS SOP instance that is already created. **The N-SET is sent over a new DICOM association**
- At the end of image acquisition, if the user has chosen 'Defer PPS', the user is provided with an interface to 'Complete PPS' or 'Discontinue PPS' at any later time. The user might wish to alter the image set generated through acquisition, before invoking these operations. Note that the user explicitly uses the user interface provided to invoke this operation, as in the case of PPS generated for post-processing, which is described in the following section. **PPS messages N-CREATE (if applicable) and N-SET will be sent over the same DICOM association**
- The remote AE returns response indicating the success/failure of the request execution. The PPS state information is updated in the system based on the response data, and is presented to the user.

2.3.1.2.7.1.1.2 PPS from acquisition system without MWL data

The system either does not have a Modality Worklist Server AE installed or a Modality Worklist Server AE installed but no Worklist information is obtained from HIS/RIS system for the current procedure that is being performed. The information required for performing the procedure is supplied through the user interface of the system. The use of this information in MPPS SOP instances is described later in this document.

- The system initiates a 'Start PPS' after the first image is acquired into the database. PPS Server AE initiates a MPPS (Modality Performed Procedure Step) N-CREATE request to the remote AE (MPPS SCP), in-order to create a MPPS SOP instance at the remote AE.
- The MPPS SCP returns response indicating the success/failure of the request execution. The PPS state information is updated in the system based on the response data, and is presented to the user. **The DICOM association is closed.**
- System includes the necessary information related to Scheduled Procedure Steps and the Performed procedure Step in the image instances created.
- At the end of image acquisition, system initiates a 'Complete PPS' or 'Discontinue PPS' based on the choice selected by the user using the user interface provided. The user is also given a choice 'Defer PPS' which is described below. PPS Server AE initiates a MPPS N-SET request to the remote AE, in-order to update the MPPS SOP instance that is already created.
- At the end of image acquisition, if the user has chosen 'Defer PPS', the user is provided with an interface to 'Complete PPS' or 'Discontinue PPS' at any later time. The user might wish to alter the image set generated through acquisition, before invoking these operations. Note

that the user explicitly uses the user interface provided to invoke this operation, as in the case of PPS generated for post-processing, which is described in the following section.

- The remote AE returns response indicating the success/failure of the request execution. The PPS state information is updated in the system based on the response data, and is presented to the user.

2.3.1.2.7.1.1.3 PPS from post-processing system

- The user initiates post-processing on the images generated through acquisition.
- The system creates a Modality Performed Procedure Step instance locally in the system. If the source image instance has the Scheduled Procedure Step information, it is copied into the image instances created. Also the system includes the necessary information related to the Modality Performed Procedure Step into the image instance.
- At the end of (one or more) post-processing, the user initiates 'Complete PPS' or 'Discontinue PPS' through the user interface provided. PPS Server AE initiates a MPPS (Modality Performed Procedure Step) N-CREATE request to the remote AE (MPPS SCP), in-order to create a MPPS SOP instance at the remote AE (which is actually a replica of the locally created MPPS SOP instance).
- The remote AE returns response indicating the success/failure of the request execution. If the response indicates success, PPS Server AE initiates a MPPS N-SET request to the remote AE, in-order to update the MPPS SOP instance that is already created, with the additional information.
- The remote AE returns response indicating the success/failure of the request execution. The PPS state information is updated in the system based on the response data, and is presented to the user.

2.3.1.2.7.2 Proposed Presentation Context

Presentation Context Table – Proposed by DICOM SERVER AE for Activity <i>Modality Performed Procedure Step Notification</i>					
Abstract Syntax		Transfer Syntax		Role	Extended
Name	UID	Name List	UID List		Negotiation
Modality Performed Procedure Step	1.2.840.10008.3.1.2.3.3	Implicit VR Little Endian Explicit VR Little Endian Explicit VR Big Endian	1.2.840.10008.1.2 1.2.840.10008.1.2.1 1.2.840.10008.1.2.2	SCU	None

2.3.1.2.7.2.1 SOP Specific DICOM Conformance Statement for MPPS SOP class

Only one association is opened at a time. The association is open until the response message is returned from the SCP or a network error occurs. No other configurable timers are available.

If the remote AE does not support the proposed Presentation context, an appropriate error message is logged.

Following are the status codes that are more specifically processed when receiving an N-CREATE and N-SET response from an **MPPS SCP** equipment:

Service Status	Status Code	Further Meaning	Application Behavior When Receiving Status Code
Success	0000	Success	System updates the state and indicates the same on the user interface
Failure	0105	No such attribute	Error message is logged into system log-file and indicates the status on the user interface
	0106	Invalid attribute value	Error message is logged into system log-file and indicates the status on the user interface
	0110	Processing failure	Error message is logged into system log-file and indicates the status on the user interface. Retries the operation after the configured time is elapsed
	0112	No such SOP Instance	Error message is logged into system log-file and indicates the status on the user interface
	0115	Invalid argument value	Error message is logged into system log-file and indicates the status on the user interface
	0117	Invalid SOP Instance	Error message is logged into system log-file and indicates the status on the user interface
	0118	No such SOP Class	Error message is logged into system log-file and indicates the status on the user interface
	0119	Class-instance conflict	Error message is logged into system log-file and indicates the status on the user interface
	0120	Missing attribute	Error message is logged into system log-file and indicates the status on the user interface
	0144	No such argument	Error message is logged into system log-file and indicates the status on the user interface
	0210	Duplicate invocation	Error message is logged into system log-file and indicates the status on the user interface
	0211	Unrecognized operation	Error message is logged into system log-file and indicates the status on the user interface
	0212	Mistyped argument	Error message is logged into system log-file and indicates the status on the user interface
	0213	Resource limitation	Error message is logged into system log-file and indicates the status on the user interface. Retries the operation after the configured time is elapsed
	C002	Operation failed	Error message is logged into system log-file and indicates the status on the user interface. Retries the operation after the configured time is elapsed
*	*	Any other status code.	The operation is deemed 'Failed'. Detailed message is logged into system log-file and indicates the status on the user interface.

			Retries the operation after the configured time is elapsed
--	--	--	--

Refer **Section.7 Modality Performed Procedure Step Implementation.**

2.3.1.2.8 Real-World Activity: Print

2.3.1.2.8.1 Associated Real-World Activity

The Film Composer allows the user to select printers and it also allows the user to drag and drop the images (from the viewer application) into the film. It also allows the user to manipulate some print parameters like film format and number of copies to print. When the user presses the "Print" Button, the Film composer communicates this request to Print SCU, which then tries to establish the association with the requested printer and transmits the images for printing.

2.3.1.2.8.1.1 Sequencing of Real-World Activities

- The DICOM printer is installed through a camera installation process. The DICOM printer is selected from the Film Composer Interface for Manual Filming. Autofilming is enabled using the camera setup via the camera installation process.
- Images may be acquired for printing in the following manner:
 - Images to be printed may be manually dropped from Viewing applications into the manual film composer slots.
 - Images to be printed may be automatically dropped from Viewing applications into the manual film composer slots.
 - Images to be printed may be manually dropped from Viewing applications into the auto film composer slots.
 - Image series to be printed may be automatically dropped from the Print Series application into the manual film composer slots.
 - Images to be printed may be automatically dropped from the Scanning Application into the auto film composer slots.
- Based upon the filming mode (and the attributes) used to acquire images into the film composer, films will be automatically printed when the film session is full, or the user must press the Print Button to print the images.
- The Print SCU will start the Print Session. The Print Session involves establishing association with the printer followed by the next sequence of activities:
 - The Print SCU gets the Print SCP status using **N-GET** service. If the Printer returns FAILURE status the print session will be terminated and the requester will be notified of the printer status.

- The film session is created using **N-CREATE** service. In case of error, the print session will be terminated. The attribute values for the Film session will be specified with the film session request.
- The film box is created using **N-CREATE** service. The print session will be terminated if the printer fails to create the film box. The film box attribute values will be sent in the film box create request
- The image attributes for the images to be printed in this session will be set using the **N-SET** service. If the printer fails to accommodate the images in the image set, the print session will be terminated. The film will be printed using the **N-ACTION** service. Only film box printing is supported. In case of error, the print session will be terminated.
- The Film Box instance will be deleted using the **N-DELETE** service.
- The SCU does not wait for **N-EVENT-REPORT** from the Printer after deleting the film box instance. The **N-EVENT-REPORT** received when the association was still active is handled, but the data received will be ignored.
- Finally the association will be terminated and if all the above operations are successful the requester will be notified of the successful print session. This status just indicates that the images to be printed have been successfully sent to the printer.

2.3.1.2.8.2 Proposed Presentation Context

The Proposed Presentation Context Table for the Print SCU is as shown in following Table.

Table 2.3.1.2.8.2-1 Presentation Context– Proposed by DICOM SERVER AE for Activity Print

Presentation Context Table – Proposed					
Abstract Syntax		Transfer Syntax		Role	Extended Negotiation
Name	SOP CLASS UID	Name	UID		
Basic Grayscale Print Management Meta SOP Class	1.2.840.10008.5.1.1.9	Implicit VR Little Endian	1.2.840.10008.1.2	SCU	None
		Explicit VR Little Endian	1.2.840.10008.1.2.1		
		Explicit VR Big Endian	1.2.840.10008.1.2.2		

Basic Color Print Management Meta SOP Class	1.2.840.10008.5.1.1.18	Implicit VR Little Endian	1.2.840.10008.1.2	SCU	None
		Explicit VR Little Endian	1.2.840.10008.1.2.1		
		Explicit VR Big Endian	1.2.840.10008.1.2.2		
Printer SOP Class	1.2.840.10008.5.1.1.16	Implicit VR Little Endian	1.2.840.10008.1.2	SCU	None
		Explicit VR Little Endian	1.2.840.10008.1.2.1		
		Explicit VR Big Endian	1.2.840.10008.1.2.2		

Note:

Support of the Basic Grayscale Print Management Meta SOP Class as an SCU mandates support for the Basic Film Session, Basic Film Box, Basic Grayscale Image Box, and Printer SOP Classes as an SCU.

Support of the Basic Color Print Management Meta SOP Class as an SCU mandates support for the Basic Film Session, Basic Film Box, Basic Color Image Box, and Printer SOP Classes as an SCU.

2.3.1.2.8.2.1 SOP Specific DICOM Conformance Statement for Basic Grayscale and Color Print Management SOP Classes

The DICOM SERVER AE uses the following DIMSE services of the supported SOP Classes for Activity Print:

Table 2.3.1.2.8.2.1-1 DIMSE Services used by DICOM SERVER AE for Activity Print

SOP Class	SOP Class UID	DIMSE Service Element	SCU Usage
Basic Film Session	1.2.840.10008.5.1.1.1	N-CREATE	Used (Mandatory)
		N-SET	Not Used
		N-DELETE	Not Used
		N-ACTION	Not Used
Basic Film Box	1.2.840.10008.5.1.1.2	N-CREATE	Used (Mandatory)
		N-ACTION	Used (Mandatory)
		N-DELETE	Used
		N-SET	Not Used
Basic Grayscale Image Box	1.2.840.10008.5.1.1.4	N-SET	Used (Mandatory)

Basic Color Image Box	1.2.840.10008.5.1.1.4.1	N-SET	Used (Mandatory)
Printer	1.2.840.10008.5.1.1.16	N-EVENT-REPORT	Used (Mandatory)
		N-GET	Used

2.3.1.2.8.2.1.1 Basic Film Session SOP Class

The DICOM SERVER AE supports the following DIMSE Service Elements for the Basic Film Session SOP Class.

- N-CREATE - Requests the Print SCP to create an instance of Basic Film Session.

Only one association is opened at a time. The association is open until the response message is returned from the SCP or a network error occurs. No other configurable timers are available.

Following are the status codes that are more specifically processed when receiving messages from a Print SCP equipment for the Basic Film Session SOP Class N-CREATE:

Table 2.3.1.2.8.2.1.1-1 Status Codes Received by DICOM SERVER AE for Basic Film Session SOP Class N-CREATE

Service Status	Status Codes	Further Meaning	Application Behavior When receiving Status Codes
Failure	0119	Class-instance conflict	Pauses print job and displays print failure message on film composer UI. Error details along with the status code is logged.
	0210	Duplicate invocation	Pauses print job and displays print failure message on film composer UI. Error details along with the status code is logged.
	0111	Duplicate SOP Instance	Pauses print job and displays print failure message on film composer UI. Error details along with the status code is logged.
	0106	Invalid attribute value	Pauses print job and displays print failure message on film composer UI. Error details along with the status code is logged.
	0117	Invalid SOP instance	Pauses print job and displays print failure message on film composer UI. Error details along with the status code is logged.
	0120	Missing attribute	Pauses print job and displays print failure message on film composer UI. Error details along with the status code is logged.
	0121	Missing attribute value	Pauses print job and displays print failure message on film composer UI. Error details along with the status code is logged.
	0212	Mistyped argument	Pauses print job and displays print failure message on film composer UI. Error details along with the status code is logged.

	0105	No such attributes	Pauses print job and displays print failure message on film composer UI. Error details along with the status code is logged.
	0118	No such SOP Class	Pauses print job and displays print failure message on film composer UI. Error details along with the status code is logged.
	0112	No such SOP Instance	Pauses print job and displays print failure message on film composer UI. Error details along with the status code is logged.
	0110	Processing failure	Pauses print job and displays print failure message on film composer UI. Error details along with the status code is logged.
	0213	Resource limitation	Pauses print job and displays print failure message on film composer UI. Resource limitation error details is logged.
	0211	Unrecognized operation	Pauses print job and displays print failure message on film composer UI. Error details along with the status code is logged.
Warning	B600	Memory allocation not supported	Pauses print job and displays print failure message on film composer UI. Error details along with the status code is logged.
Success	0000	Film session successfully created	Logs film session instance UID and proceeds for creating film box.
*	*	Any other status code.	Pauses print job and displays print failure message on film composer UI. Error details along with the status code is logged.

If a Failure/Warning status is returned by the Print SCP during the N-CREATE operation of the Film Session, the association will be terminated.

2.3.1.2.8.2.1.2 Basic Film Box SOP Class

The DICOM SERVER AE supports the following DIMSE Service Elements for the Basic Film Box SOP Class:

- N-CREATE - Requests the Print SCP to create an instance of Film Box.
- N-ACTION - Requests the Print SCP to print the Film Box onto Printer.
- N-DELETE - Requests the Print SCP to delete the Film Box Instance.

Only one association is opened at a time. The association is open until the response message is returned from the SCP or a network error occurs. No other configurable timers are available.

Following are the status codes that are more specifically processed when receiving messages from a **Print** SCP equipment for the Basic Film Box SOP Class N-CREATE:

Table 2.3.1.2.8.2.1.2-1 Status Codes Received by DICOM SERVER AE for Basic Film Box SOP Class N-CREATE

Service	Status	Further Meaning	Application Behavior When receiving
---------	--------	-----------------	-------------------------------------

Status	Codes		Status Codes
Failure	C616	There is an existing Film Box that has not been printed and N-ACTION at the Film Session level is not supported. A new Film Box will not be created when a previous Film Box has not been printed.	Pauses print job and displays print failure message on film composer UI. Error details along with the status code is logged.
	0119	Class-instance conflict	Pauses print job and displays print failure message on film composer UI. Error details along with the status code is logged.
	0210	Duplicate invocation	Pauses print job and displays print failure message on film composer UI. Error details along with the status code is logged.
	0111	Duplicate SOP Instance	Pauses print job and displays print failure message on film composer UI. Error details along with the status code is logged.
	0106	Invalid attribute value	Pauses print job and displays print failure message on film composer UI. Error details along with the status code is logged.
	0117	Invalid SOP instance	Pauses print job and displays print failure message on film composer UI. Error details along with the status code is logged.
	0120	Missing attribute	Pauses print job and displays print failure message on film composer UI. Error details along with the status code is logged.
	0121	Missing attribute value	Pauses print job and displays print failure message on film composer UI. Error details along with the status code is logged.
	0212	Mistyped argument	Pauses print job and displays print failure message on film composer UI. Error details along with the status code is logged.
	0105	No such attributes	Pauses print job and displays print failure message on film composer UI. Error details along with the status code is logged.
	0118	No such SOP Class	Pauses print job and displays print failure message on film composer UI. Error details along with the status code is logged.
	0112	No such SOP Instance	Pauses print job and displays print failure message on film composer UI. Error details along with the status code is logged.
	0110	Processing failure	Pauses print job and displays print failure message on film composer UI. Error details along with the status code is logged.
	0213	Resource limitation	Pauses print job and displays print failure message on film composer UI. Resource limitation error details is logged.
0211	Unrecognized operation	Pauses print job and displays print failure message on film composer UI. Error details along with the status code is logged.	
Warning	B605	Requested Min Density or Max Density outside of printer's	Pauses print job and displays print failure message on film composer UI. Error details

		operating range. The printer will use its respective minimum or maximum density value instead.	along with the status code is logged.
Success	0000	Film box successfully created	Proceed for setting image box.
*	*	Any other status code.	Pauses print job and displays print failure message on the film composer UI. Error details along with the status code is logged.

If a Failure or Warning status is returned during the N-CREATE operation of the Film Box, the association will be terminated.

Following are the status codes that are more specifically processed when receiving messages from a **Print SCP** equipment for the Basic Film Box SOP Class N-ACTION:

Table 2.3.1.2.8.2.1.2-2 Status Codes Received by DICOM SERVER AE for Basic Film Box SOP Class N-ACTION

Service Status	Status Codes	Further Meaning	Application Behavior When receiving Status Codes
Failure	C602	Unable to create Print Job SOP Instance; print queue is full	Logs "unable to create print job" error. Pauses print job and displays print failure message on the film composer UI.
	C603	Image size is larger than image box size (by using the specified magnification value)	Pauses print job and displays print failure message on the film composer UI. Error details along with the status code is logged.
	C604	Image position collision : multiple images assigned to single image position	Pauses print job and displays print failure message on the film composer UI. Error details along with the status code is logged.
	C613	Combined Print Image size is larger than the Image Box size	Pauses print job and displays print failure message on the film composer UI. Error details along with the status code is logged.
	0119	Class-instance conflict	Pauses print job and displays print failure message on the film composer UI. Error details along with the status code is logged.
	0210	Duplicate invocation	Pauses print job and displays print failure message on the film composer UI. Error details along with the status code is logged.
	0115	Invalid argument value	Pauses print job and displays print failure message on the film composer UI. Error details along with the status code is logged.
	0117	Invalid SOP Instance	Pauses print job and displays print failure message on the film composer UI. Error details along with the status code is logged.
	0212	Mistyped argument	Pauses print job and displays print failure message on the film composer UI. Error details along with the status code is logged.
	0123	No such action	Pauses print job and displays print failure message on the film composer UI. Error details along with the status code is logged.

	0114	No such argument	Pauses print job and displays print failure message on the film composer UI. Error details along with the status code is logged.
	0118	No such SOP Class	Pauses print job and displays print failure message on the film composer UI. Error details along with the status code is logged.
	0112	No such SOP Instance	Pauses print job and displays print failure message on the film composer UI. Error details along with the status code is logged.
	0110	Processing failure	Pauses print job and displays print failure message on the film composer UI. Error details along with the status code is logged.
	0213	Resource limitation	Pauses print job and displays print failure message on the film composer UI. Error details along with the status code is logged.
	0211	Unrecognized operation	Pauses print job and displays print failure message on the film composer UI. Error details along with the status code is logged.
Warning	B603	Film Box SOP Instance hierarchy does not contain Image Box SOP Instances (empty page)	Pauses print job and displays print failure message on the film composer UI. Error details along with the status code is logged.
	B604	Image size is larger than image box size, the image has been demagnified.	Pauses print job and displays print failure message on the film composer UI. Error details along with the status code is logged.
	B609	Image size is larger than the Image Box size. The Image has been cropped to fit.	Pauses print job and displays print failure message on the film composer UI. Error details along with the status code is logged.
	B60A	Image size or Combined Print Image size is larger than the Image Box size. Image or Combined Print Image has been decimated to fit.	Pauses print job and displays print failure message on the film composer UI. Error details along with the status code is logged.
Success	0000	Film accepted for printing; if supported, the Print Job SOP Instance is created	Proceed in parsing N-Action response.
*	*	Any other status code.	Pauses print job and displays print failure message on the film composer UI. Error details along with the status code is logged.

If a Failure or Warning status is returned during the N-ACTION operation of the Film Box, the association will be terminated.

Following are the status codes that are more specifically processed when receiving messages from a **Print SCP** equipment for the Basic Film Box SOP Class N-DELETE:

Table 2.3.1.2.8.2.1.2-3 Status Codes Received by DICOM SERVER AE for Basic Film Box SOP Class N-DELETE

Service Status	Status Codes	Further Meaning	Application Behavior When receiving Status Codes
Failure	0119	Class-instance conflict	Pauses print job and displays print failure message on the film composer UI. Error

			details along with the status code is logged.
	0210	Duplicate invocation	Pauses print job and displays print failure message on the film composer UI. Error details along with the status code is logged.
	0117	Invalid SOP instance	Pauses print job and displays print failure message on the film composer UI. Error details along with the status code is logged.
	0212	Mistyped argument	Pauses print job and displays print failure message on the film composer UI. Error details along with the status code is logged.
	0118	No such SOP Class	Pauses print job and displays print failure message on the film composer UI. Error details along with the status code is logged.
	0112	No such SOP Instance	Pauses print job and displays print failure message on the film composer UI. Error details along with the status code is logged.
	0110	Processing failure	Pauses print job and displays print failure message on the film composer UI. Error details along with the status code is logged.
	0213	Resource limitation	Pauses print job and displays print failure message on the film composer UI. Error details along with the status code is logged.
	0211	Unrecognized operation	Pauses print job and displays print failure message on the film composer UI. Error details along with the status code is logged.
Success	0000	Film box successfully deleted	Logs the success message.
*	*	Any other status code.	Pauses print job and displays print failure message on the film composer UI. Error details along with the status code is logged.

If a Failure or Warning status is returned during the N-DELETE operation of the Film Box, the association will be terminated.

2.3.1.2.8.2.1.3 Basic Grayscale and Color Image Box SOP Classes

The DICOM SERVER AE supports the following DIMSE Service Elements for Basic Grayscale and Color Image Box SOP Classes :

- N-SET - Requests the Printer to set the image box attributes.

Only one association is opened at a time. The association is open until the response message is returned from the SCP or a network error occurs. No other configurable timers are available.

Following are the status codes that are more specifically processed when receiving messages from a **Print** SCP equipment for the Basic Grayscale and Color Image Box SOP Classes N-SET:

Table 2.3.1.2.8.2.1.3-1 Status Codes Received by DICOM SERVER AE for Basic Grayscale and Color Image Box SOP Classes N-SET

Service Status	Status Codes	Further Meaning	Application Behavior When receiving Status Codes
Failure	C603	Image size is larger than image box size	Pauses print job and displays print failure message on the film composer UI. Error details along with the status code is logged.
	C605	Insufficient memory in printer to store the image	Log printer memory full error. Pauses print job and displays print failure message on the film composer UI.
	C613	Combined Print Image size is larger than the Image Box size	Pauses print job and displays print failure message on the film composer UI. Error details along with the status code is logged.
	0119	Class-instance conflict	Pauses print job and displays print failure message on the film composer UI. Error details along with the status code is logged.
	0210	Duplicate invocation	Pauses print job and displays print failure message on the film composer UI. Error details along with the status code is logged.
	0106	Invalid attribute value	Pauses print job and displays print failure message on the film composer UI. Error details along with the status code is logged.
	0212	Mistyped argument	Pauses print job and displays print failure message on the film composer UI. Error details along with the status code is logged.
	0117	Invalid SOP instance	Pauses print job and displays print failure message on the film composer UI. Error details along with the status code is logged.
	0121	Missing attribute value	Pauses print job and displays print failure message on the film composer UI. Error details along with the status code is logged.
	0105	No such attributes	Pauses print job and displays print failure message on the film composer UI. Error details along with the status code is logged.

	0118	No such SOP Class	Pauses print job and displays print failure message on the film composer UI. Error details along with the status code is logged.
	0112	No such SOP Instance	Pauses print job and displays print failure message on the film composer UI. Error details along with the status code is logged.
	0110	Processing failure	Pauses print job and displays print failure message on the film composer UI. Error details along with the status code is logged.
	0213	Resource limitation	Pauses print job and displays print failure message on the film composer UI. Error details along with the status code is logged.
	0211	Unrecognized operation	Pauses print job and displays print failure message on the film composer UI. Error details along with the status code is logged.
Warning	B604	Image size larger than image box size, the image has been demagnified.	Pauses print job and displays print failure message on the film composer UI. Error details along with the status code is logged.
	B605	Requested Min Density or Max Density outside of printer's operating range. The printer will use its respective minimum or maximum density value instead.	Pauses print job and displays print failure message on the film composer UI. Error details along with the status code is logged.
	B609	Image size is larger than the Image Box size. The Image has been cropped to fit.	Pauses print job and displays print failure message on the film composer UI. Error details along with the status code is logged.
	B60A	Image size or Combined Print Image size is larger than the Image Box size. The Image or Combined Print Image has been decimated to fit.	Pauses print job and displays print failure message on the film composer UI. Error details along with the status code is logged.
Success	0000	Image successfully stored in Image Box	Continues setting image box if more images are there, else sends N-Action request.
*	*	Any other status code.	Pauses print job and displays print failure message on the film composer UI. Error details along with the status code is logged.

If a Failure/Warning status is returned during the N-SET operation of the Image Box, the association will be terminated.

2.3.1.2.8.2.1.4 Printer SOP Class

The N-GET DIMSE service is supported for the Printer SOP Class. If an N-EVENT-REPORT DIMSE service is received when the association is active, the DICOM SERVER AE handles the relevant states, but the data received is ignored.

Following are the status codes the Application may send back in the **N-Event-Report** response command to the **Printer SOP Class** SCP Equipment that sent the N-Event-Report request:

Table 2.3.1.2.8.2.1.4-1 Status Codes Returned by DICOM SERVER AE for Printer SOP Class N-Event-Report

Service Status	Status Code	Further Meaning	Status Code Explanation	Related Fields Sent Back to the SCU
Success	0000		N-EVENT-REPORT received successfully	None

The DICOM SERVER AE issues the N-GET service to retrieve the printer status. The statuses are processed as follows:

- If Printer status (2110,0010) is NORMAL, the film is printed.
- If Printer status (2110,0010) is FAILURE the print job is terminated. The Printer Status Info (2110,0020) attribute is not processed.
- If Printer status (2110,0010) is WARNING one of two things will happen:
 - If the Printer Status Info (2110,0020) is "RECEIVER FULL" or "SUPPLY EMPTY", or "FILM JAM" the status is displayed to the user and the print job is aborted.
 - For all other Printer Status Info (2110,0020) values, the status is ignored and the print job continues.

Only one association is opened at a time. The association is open until the response message is returned from the SCP or a network error occurs. No other configurable timers are available.

For the attribute list requested by this product and for the behavior of this product on each returned value, refer to Section 4.6 **Printer SOP Class**.

Following are the status codes that are more specifically processed when receiving messages from a **Print** SCP equipment for the Printer SOP Class N-GET:

2.3.1.2.8.2.1.4-2 Status Codes Received by DICOM SERVER AE for Printer SOP Class N-GET

Service Status	Status Codes	Further Meaning	Application Behavior When receiving Status Codes
Failure	0107	Attribute list error	Pauses print job and displays print failure

			message on the film composer UI. Error details along with the status code is logged.
	0119	Class-instance conflict	Pauses print job and displays print failure message on the film composer UI. Error details along with the status code is logged.
	0210	Duplicate invocation	Pauses print job and displays print failure message on the film composer UI. Error details along with the status code is logged.
	0117	Invalid SOP instance	Pauses print job and displays print failure message on the film composer UI. Error details along with the status code is logged.
	0212	Mistyped argument	Pauses print job and displays print failure message on the film composer UI. Error details along with the status code is logged.
	0118	No such SOP Class	Pauses print job and displays print failure message on the film composer UI. Error details along with the status code is logged.
	0112	No such SOP Instance	Pauses print job and displays print failure message on the film composer UI. Error details along with the status code is logged.
	0110	Processing failure	Pauses print job and displays print failure message on the film composer UI. Error details along with the status code is logged.
	0213	Resource limitation	Pauses print job and displays print failure message on the film composer UI. Error details along with the status code is logged.
	0211	Unrecognized operation	Pauses print job and displays print failure message on the film composer UI. Error details along with the status code is logged.
Success	0000	Success	Proceed with parsing dataset returned from N-Get response and perform appropriate operations. Refer section 4.2.5
*	*	Any other status code.	Pauses print job and displays print failure message on the film composer UI. Error details along with the status code is logged.

Refer **Section.4 Print Management Implementation.**

2.3.1.3 Association Acceptance Policy

The DICOM Server AE places limitations on who may connect to it.

If the Remote AE needs to “Push Images” or “Query/Retrieve Images”, to the local system then it has to be configured in the Local system to do the same.

When the DICOM Server AE accepts an association for image storage, it will receive any images transmitted on that association and store the images on disk.

It will also respond to queries from Remote AEs by sending matching entries. Any Remote AE can request and receive a list of images on the local database. The Remote AE must be configured in the local database manager’s list of Remote AE for it to be able to retrieve images from DICOM Server AE.

Any remote AE can open an association to the DICOM Server AE for the purpose of verification.

It will also listen for and receive Storage Commitment notification (N-EVENT-REPORT) from a Remote Storage commitment SCP.

2.3.1.3.1 Real-World Activity: Receive Images

This AE is indefinitely listening for associations. No operator action is required to receive an image.

2.3.1.3.1.1 Associated Real-World Activity

The Real-World Activity associated with the Receive Image(s) operation is the storage of the image on the disk drive of the GEHC CT.

2.3.1.3.1.2 Presentation Context Table

Table 2.3.1.3.1.2-1: Accepted Presentation Contexts for DICOM Server AE and Real-World Activity Receive Image(s)

Presentation Context Table – Accepted					
Abstract Syntax		Transfer Syntax		Role	Extended Negotiation
Name	UID	Name List	UID List		
CT Image Storage	1.2.840.10008.5.1.4.1.1.2	Implicit VR Little Endian Explicit VR Little Endian Explicit VR Big Endian	1.2.840.10008.1.2 1.2.840.10008.1.2.1 1.2.840.10008.1.2.2	SCP	None
MR Image Storage	1.2.840.10008.5.1.4.1.1.4	Implicit VR Little Endian Explicit VR Little Endian Explicit VR Big Endian	1.2.840.10008.1.2 1.2.840.10008.1.2.1 1.2.840.10008.1.2.2	SCP	None

			2.2		
PET Image Storage	1.2.840.10008.5.1.4.1.1.128	Implicit VR Little Endian Explicit VR Little Endian Explicit VR Big Endian	1.2.840.10008.1.2 1.2.840.10008.1.2.1 1.2.840.10008.1.2.2	SCP	None
RT Structure Set Storage	1.2.840.10008.5.1.4.1.1.481.3	Implicit VR Little Endian Explicit VR Little Endian Explicit VR Big Endian	1.2.840.10008.1.2 1.2.840.10008.1.2.1 1.2.840.10008.1.2.2	SCP	None
Secondary Capture Image Storage	1.2.840.10008.5.1.4.1.1.7	Implicit VR Little Endian Explicit VR Little Endian Explicit VR Big Endian	1.2.840.10008.1.2 1.2.840.10008.1.2.1 1.2.840.10008.1.2.2	SCP	None
Enhanced SR	1.2.840.10008.5.1.4.1.1.88.22	Implicit VR Little Endian Explicit VR Little Endian Explicit VR Big Endian	1.2.840.10008.1.2 1.2.840.10008.1.2.1 1.2.840.10008.1.2.2	SCP	None
X-Ray Radiation Dose SR	1.2.840.10008.5.1.4.1.1.88.67	Implicit VR Little Endian Explicit VR Little Endian Explicit VR Big Endian	1.2.840.10008.1.2 1.2.840.10008.1.2.1 1.2.840.10008.1.2.2	SCP	None

Note: The SCP does not have a default acceptance policy if more than one acceptable transfer syntaxes are proposed by the SCU. It is the responsibility of the SCU to make a selection from more than one transfer syntaxes accepted. If multiple transfer syntaxes are proposed in the same presentation context, the SCP will accept the first one

2.3.1.3.1.2.1 SOP Specific Conformance to C_STORE SCP

The DICOM Server AE conforms to the SOP's of the Storage Service Class at Level 2 (FULL), and stores all standard and private data elements of received SOP Instances. It does not coerce any data elements during Storage. The DICOM SERVER AE provides Level 1 Digital Signature support.

Each C-STORE SCP operation supports an "Association Timer" and "Operation Inactivity Timer" with time out values of 30 seconds, 15 seconds respectively and is configurable.

- Association Timer – duration for SCP to respond to an association request.

- Operation Inactivity Timer – duration between two commands after the association.

Successfully received SOP Instances may be accessed via the user interface and by DICOM network query retrieve. SOP Instances are stored until manually deleted by the user

Image Reception

If the DICOM Server AE returns one of the following status codes, then the C-STORE operation was unsuccessful and no image will be installed. A message will appear in the system log informing the user of the failure.

Service Status	Status Code	Further Meaning	Status Code Explanation	Related Fields Sent Back to the SCU
Failure	A700	Refused: Out of resources	Not enough disk space to store DICOM image.	(0000,0902)
	A710	Refused: Out of Resources	Remote AE is not given permission to store on this AE	(0000,0902)
	A711	Refused: Out of resources	Unable to connect to local database for storage. (such as maximum connection limit reached)	(0000,0902)
	A900	Error: Data Set does not match SOP Class	Storage of the DICOM object in local database failed due to corrupt/invalid data set.	(0000,0902)
	C000	Error: Cannot understand	Storage of the DICOM object in local database failed.	(0000,0902)

In the event of a successful C-STORE operation (Status Code 0000), the image has successfully been written to disk. The image will then be accessed in the same manner as any other image by the applications on the GEHC CT system.

Images may be deleted when instructed to do so by the user. Thus the duration of the storage of the image is determined by the users of the GEHC CT system.

Image Installation

If the image installation is unsuccessful, a message will appear in the Message Log informing the user of the failure and the image will be removed.

If the image installation process finds that an element is not encoded according to the DICOM standard, it will fail to install the image and the file will be removed.

Image Installation of non-GE Created MR or CT Images

Images received from non-GE products are installed as the appropriate image object. Their private data elements will be maintained if the negotiated transfer syntax is Explicit Little or Big Endian. Also if any critical fields (mandatory) are missing, then the image will not be installed.

This AE is indefinitely listening for associations. No operator action is required to respond to a *verification* message.

2.3.1.3.1.3 Presentation Context Acceptance Criterion

The DICOM SERVER AE evaluates each Presentation Context independently, and accepts any Presentation Context that matches an Abstract Syntax for any Real-World Activity.

2.3.1.3.1.4 Transfer Syntax Selection Policies

Within each Presentation Context, the DICOM SERVER AE will select Transfer Syntaxes according to the following priority (highest priority first):

1. Explicit VR Little Endian
2. Implicit VR Little Endian
3. Explicit VR Big Endian

2.3.1.3.2 Real-World Activity: Verification Request from Remote AE

2.3.1.3.2.1 Associated Real-World Activity

This AE is indefinitely listening for associations. No operator action is required to respond to a verification message. The Real-World Activity associated with the verification request is to send a C-ECHO response message with a status of “success” to the requesting AE.

2.3.1.3.2.2 Presentation Context Table

Table 2.3.1.3.2.2-1: Acceptable Presentation Contexts for DICOM Server AE and Real-World Activity Verification Request

Presentation Context Table					
Abstract Syntax		Transfer Syntax		Role	Extended Negotiation
Name	UID	Name List	UID List		
Verification	1.2.840.10008.1.1	Implicit VR Little Endian	1.2.840.10008.1.2	SCP	None
		Explicit VR Little Endian	1.2.840.10008.1.2.1		
		Explicit VR Big Endian	1.2.840.10008.1.2.2		

2.3.1.3.2.2.1 SOP Specific Conformance to C_ECHO SCP

The DICOM Server AE provides standard conformance to the DICOM Verification Service Class.

Each ECHO operation supports an “Association Timer” and “Operation Inactivity Timer” with time out values of 30 seconds and 15 seconds respectively.

2.3.1.3.2.3 Presentation Context Acceptance Criterion

The DICOM SERVER AE evaluates each Presentation Context independently, and accepts any Presentation Context that matches an Abstract Syntax for any Real-World Activity.

2.3.1.3.2.4 Transfer Syntax Selection Policies

Within each Presentation Context, the DICOM SERVER AE will select Transfer Syntaxes according to the following priority (highest priority first):

1. Explicit VR Little Endian
2. Implicit VR Little Endian
3. Explicit VR Big Endian

2.3.1.3.3 Real-World Activity: Search Local Database (Query Request from Remote AE)

This AE is indefinitely listening for associations. No operator action is required to respond to a *query* request.

2.3.1.3.3.1 Associated Real-World Activity

The Real-World Activity associated with “*Search Local Database*” is to search the local database for entries that match the request and send a C-FIND response message with a status of “pending” for each matching entry and send a C-FIND response message with a status of “success” after the last “pending” response.

If the C-FIND SCP receives a C-FIND-CANCEL request, it sends a C-FIND response message with a status of “cancel (FE00H)”.

2.3.1.3.3.2 Presentation Context Table

Table 2.3.1.3.3.2-1: Acceptable Presentation Contexts for DICOM Server AE and Real-World Activity Query Request

Presentation Context Table					
Abstract Syntax		Transfer Syntax		Role	Extended Negotiation
Name	UID	Name List	UID List		
Study Root Query/Retrieve FIND	1.2.840.10008.5.1.4.1.2.1	Implicit VR Little Endian	1.2.840.10008.1.2	SCP	None
		Explicit VR Little Endian	1.2.840.10008.1.2.1		
		Explicit VR Big Endian	1.2.840.10008.1.2.2		

2.3.1.3.3.2.1 SOP Specific Conformance to C-FIND SCP

Each C-FIND SCP operation supports an “Association Timer” and “Operation Inactivity Timer” with time out values of 30 seconds and 15 seconds respectively.

All Required (R) and Unique (U) study, series, and image level keys for the Study-Root Query/Retrieve information model are supported. Some optional (O) keys are also supported as described in the following tables.

Table 2.3.1.3.3.2.1-1 Supported study level keys

Description	Type	Tag	Usage
Study date	R	0008,0020	Matched
Study time	R	0008,0030	Matched
Accession number	R	0008,0050	Matched
Patient’s name	R	0010,0010	Matched
Patient id	R	0010,0020	Matched
Study id	R	0020,0010	Matched
Study Instance UID	U	0020,000D	Matched
Study description	O	0008,1030	Returned
Suite Id	P	0009,0002	Returned

Table 2.3.1.3.3.2.1-2 Supported series level keys

Description	Type	Tag	Usage
Modality	R	0008,0060	Matched
Series number	R	0020,0011	Matched
Series Instance UID	U	0020,000E	Matched
Series description	O	0008,103E	Returned
Manufacturer	O	0008,0070	Returned
Images in series	O	0020,1002	Returned

Table 2.3.1.3.3.2.1-3 Supported image level keys

Description	Type	Tag	Usage
Image number	R	0020,0013	Matched
Image Instance UID	U	0008,0018	Matched
Image type	O	0008,0008	Returned
Rows	O	0028,0010	Returned
Columns	O	0028,0011	Returned
Image position	O	0020,0032	Returned
Image orientation	O	0020,0037	Returned
Slice thickness	O	0018,0050	Returned
Slice spacing	O	0018,0088	Returned
Gantry tilt	O	0018,1120	Returned
Convolution kernel	O	0018,1210	Returned

Description	Type	Tag	Usage
Reconstruction diameter	O	0018,1100	Returned
Data collection diameter	O	0018,0090	Returned
Flip angle	O	0018,1314	Returned
Echo number	O	0018,0086	Returned
Echo time	O	0018,0081	Returned
Inversion time	O	0018,0082	Returned
Repetition time	O	0018,0080	Returned
Trigger time	O	0018,1060	Returned
Dfov Rect	P	0019,001E	Returned
Midscan Time	P	0019,0024	Returned
Azimuth	P	0019,0026	Returned
Number of Echo	P	0019,007E	Returned
Scout Anref	P	0021,004A	Returned
Location RAS	P	0027,0040	Returned
Location	P	0027,0041	Returned
Center R Coordinate	P	0027,0042	Returned
Center A Coordinate	P	0027,0043	Returned
Table Start Location	P	0027,0050	Returned
Table End Location	P	0027,0051	Returned
RAS Letter for Side of Image	P	0027,0052	Returned
RAS Letter for Anterior/Posterior	P	0027,0053	Returned
RAS Letter for Scout Start Location	P	0027,0054	Returned
RAS Letter for Scout End Location	P	0027,0055	Returned
Image Dimension X	P	0027,0060	Returned
Image Dimension Y	P	0027,0061	Returned

Note: In the above tables the type field has the following meaning:
R = Required **U** = Unique **O** = Optional **P** = Private

Only keys with Usage type *Matched* will be matched against values in the database.

Values in keys of type Returned will be ignored and will be filled in with data from the database.

If an optional key is requested that does not appear in any of the tables above, that key will be ignored and no corresponding element will be returned.

If the database does not have a value corresponding to any requested optional key a zero-length element will be returned.

Sequence matching is not supported.

Range matching is supported for attributes of type date and time.

Only hierarchical query is supported.

Special character ? can be used to match any single character and special character * can be used to match any character or set of characters for (0008, 0050) Accession Number, (0010, 0010) Patient's Name, (0010, 0020) Patient ID and (0020, 0010) Study ID.

Except sequence matching all other matching are supported. (i.e. wildcard ("*", "?") and range ("-") matching is supported as defined in DICOM PS3.4 Section C.2 *Query/Retrieve Information Model Definition*.)

Following are the status codes the Application may send back to the SCU Equipment while performing the requested **Query**:

Service Status	Status Code	Further Meaning	Status Code Explanation	Related Fields Sent Back to the SCU
Failure	A900	Error: Invalid dataset	This status code is sent for the following reasons 1. When does not have required information, like query retrieve level	(0000,0902)
	C001	Error: Unable to process	This status code is sent for the following reasons 1. When remote AE is not given permission to store on this AE. 2. Not able to connect to local database, because of max connection limit reached. 3. Database query fails.	(0000,0902)
Cancel	FE00	Matching terminated due to cancel	This status code will be returned when DICOM SERVER AE receives C-FIND-CANCEL from remote AE	None
Success	0000	Matching is complete - No final identifier is supplied	Matching complete	None
Pending	FF00	Matches are continuing - Current Match is supplied and any Optional Keys were supported in the same manner as Required Keys.	For pending messages	Identifier

2.3.1.3.3.3 Presentation Context Acceptance Criterion

The DICOM SERVER AE evaluates each Presentation Context independently, and accepts any Presentation Context that matches an Abstract Syntax for any Real-World Activity.

2.3.1.3.3.4 Transfer Syntax Selection Policies

Within each Presentation Context, the DICOM SERVER AE will select Transfer Syntaxes according to the following priority (highest priority first):

1. Explicit VR Little Endian
2. Implicit VR Little Endian
3. Explicit VR Big Endian

2.3.1.3.4 Real-World Activity: Move Images (Retrieve Request from Remote AE)

This AE is indefinitely listening for associations. No operator action is required to respond to a *retrieve* request.

2.3.1.3.4.1 Associated Real-World Activity

The Real-World Activity associated with “*Move Images*” is to send all images corresponding to the C-MOVE request to the destination AE through a separate association.

If the C-MOVE SCP receives a C-MOVE-CANCEL request, it discontinues the move operation and closes the separate association.

2.3.1.3.4.2 Presentation Context Table

Table 2.3.1.3.4.2-1: Acceptable Presentation Contexts for DICOM Server AE and Real-World Activity “Move Images”

Presentation Context Table					
Abstract Syntax		Transfer Syntax		Role	Extended Negotiation
Name	UID	Name List	UID List		
Study Root Query/Retrieve MOVE	1.2.840.10008.5.1.4.1.2.2	Implicit VR Little Endian Explicit VR Little Endian Explicit VR Big Endian	1.2.840.10008.1.2 1.2.840.10008.1.2.1 1.2.840.10008.1.2.2	SCP	None

2.3.1.3.4.2.1 SOP Specific Conformance to C-MOVE SCP

The DICOM Server AE provides standard conformance to the baseline Study-root C-MOVE Service Class SCP.

Each C-MOVE SCP operation supports an “Association Timer” and “Operation Inactivity Timer” with time out values of 30 seconds and 15 seconds and 60 minutes respectively. All images requested in a C-MOVE-RQ will be sent over a single association.

A C-MOVE-RSP with a “pending” status will be returned to the requester every five images.

C-MOVE supports list of Studies (through list of Study UIDs), list of Series (through list of Series UIDs) and list of Images (through list of Instances UIDs).

To send C-MOVE to a 3rd party system is supported if 3rd party destination AE details are configured in the system.

The C-MOVE SCP will invoke C-STORE requests for the following SOP classes:

SOP Class Name	SOP Class UID
CT Image Information Storage	1.2.840.10008.5.1.4.1.1.2
MR Image Information Storage	1.2.840.10008.5.1.4.1.1.4
PET Image Information Storage	1.2.840.10008.5.1.4.1.1.128
RT Structure Set Storage	1.2.840.10008.5.1.4.1.1.481.3
Secondary Capture image storage	1.2.840.10008.5.1.4.1.1.7
Grayscale Softcopy Presentation State Storage	1.2.840.10008.5.1.4.1.1.11.1
Enhanced SR	1.2.840.10008.5.1.4.1.1.88.22
X-Ray Radiation Dose SR	1.2.840.10008.5.1.4.1.1.88.67

Following are the status codes the Application may send back to the SCU Equipment while performing the requested Retrieve:

Service Status	Status Code	Further Meaning	Status Code Explanation	Related Fields Sent Back to the SCU
Failure	A701	Refused: Out of resources - Unable to calculate number of matches	This status code is sent when local database query fails	(0000,0902)
	A702	Refused: Out of resources - Unable to perform sub-operations	This status code is sent to Retrieve SCU when the association is rejected by the C-STORE SCP	(0000,0902)
	A801	Error: Move Destination Unknown	This status code is sent when the destination AE named in the C-MOVE request is unknown to DICOM SERVER AE.	(0000,0902)
	A900	Error: Invalid dataset	This status code is sent for the following reasons 1.When the retrieve request does not contain required information, like query retrieve level	(0000,0902)

	C001	Error: Unable to process	This status code is sent for the following reasons 1. When Remote AE does not have permissions to use DICOM SERVER AEs retrieve service 2. Not able to connect to local database, because of max connection limit reached. 3. Database query fails.	(0000,0902)
Cancel	FE00	Sub-operations terminated due to a Cancel indication	This status code is sent when DICOM SERVER AE receives C-MOVE-CANCEL request from the Remote AE.	(0000,1021) (0000,1022) (0000,1023) (0000,0902))
Success	0000	Sub-operations Complete - No Failure.	All the composite SOP instances have been successfully sent to the C-MOVE destination	(0000,1021) (0000,1022) (0000,1023)
Pending	FF00	Sub-operations are continuing -	For pending sub operation to remote AE	(0000,1020) (0000,1021) (0000,1022) (0000,1023)

2.3.1.3.4.3 Presentation Context Acceptance Criteria

The DICOM SERVER AE evaluates each Presentation Context independently, and accepts any Presentation Context that matches an Abstract Syntax for any Real-World Activity.

2.3.1.3.4.4 Transfer Syntax Selection Policy

Within each Presentation Context, the DICOM SERVER AE will select Transfer Syntaxes according to the following priority (highest priority first):

1. Explicit VR Little Endian
2. Implicit VR Little Endian
3. Explicit VR Big Endian

2.3.1.3.5 Real-World Activity: Listen to remote Storage Commitment SCP

The DICOM SERVER AE is indefinitely listening for associations. No operator action is required to receive a Storage Commitment notification (N-EVENT-REPORT).

2.3.1.3.5.1 Associated Real-World Activity

The Real-World Activity associated consists into:

- Flag the exams/series that have been committed (transfer of ownership) in the database
- Display the error when some images of a patient existing in the database have not been committed

2.3.1.3.5.2 Presentation Context Table

Presentation Context Table – Accepted by DICOM SERVER AE for Activity Storage commit notification from Remote AE					
Abstract Syntax		Transfer Syntax		Role	Extended Negotiation
Name	UID	Name List	UID List		
Storage Commitment Push Model	1.2.840.10008.1.20.1	Implicit VR Little Endian Explicit VR Little Endian Explicit VR Big Endian	1.2.840.10008.1.2 1.2.840.10008.1.2.1 1.2.840.10008.1.2.2	SCU	None

2.3.1.3.5.2.1 SOP Specific DICOM Conformance Statement for the Storage Commitment Push Model SOP Class (N-EVENT-REPORT)

The DICOM SERVER AE monitors an “Operation Inactivity” timer. The connection with the SCU will be terminated if it is inactive for the configured time-out interval. Default time-out is 15 seconds and is configurable.

Once the N_EVENT_REPORT response is received from the SCP, the following actions will be taken depending on the status of response.

2.3.1.3.5.2.1.1 Commitment response with SUCCESS status

The “Archived” flag information in the browser for all the successfully archived exam/series will be updated. The archive status column in the browser will be changed to display “Archived” icon to indicate that the exam/series has been archived successfully. The job queue entry will be removed. N_EVENT_REPORT response will be sent on the same association as N_EVENT_REPORT request. No data set will be sent along with the response.

Following are the status codes the Application may send back to the SCP Equipment after receiving the N-EVENT-REPORT:

Service Status	Status Codes	Further Meaning	Status Code sending explanation	Related Fields sent back to the SCU
Error	0110	Processing Failure	Indicates that an internal error occurred while processing.	None
Success	0000	Success	The storage commitment result received successfully.	None

2.3.1.3.5.2.1.2 Commitment response with FAILURE status

In the event of complete/partial failure the user will be notified about the status and the job entry will be paused. There is no attempt made to automatically retry the failed SOP instances. However the user can manually retry the failed jobs. Such requests will be treated as new requests. This will go through the complete sequence of operations once again.

The failure reason is ignored. Failed SOP instances will have their “Archived” flag information unaltered. Failed SOP instances are logged.

Note: The archived status flag in the browser is a shared flag with local archive. When the status is “Archived”, it means that the images are archived but doesn’t specify whether on local archive device or remote archive device. It is left to the user’s discretion whether the local SOP instances are to be deleted.

N_EVENT_REPORT response will be sent on the same association as N_EVENT_REPORT request. No data set will be sent along with the response.

Please see [section 5.1.2.1](#) for the complete list of N_EVENT_REPORT failure statuses processed by the system.

Following are the status codes the Application may send back to the SCP Equipment after receiving the N-EVENT-REPORT:

Service Status	Status Codes	Further Meaning	Status Code sending explanation	Related Fields sent back to the SCU
Error	0110	Processing Failure	Indicates that an internal error occurred while processing.	None
Success	0000	Success	The storage commitment result received successfully.	None

2.3.1.3.5.3 Presentation Context Acceptance Criterion

The DICOM SERVER AE evaluates each Presentation Context independently, and accepts any Presentation Context that matches an Abstract Syntax for any Real-World Activity.

2.3.1.3.5.4 Transfer Syntax Selection Policies

Within each Presentation Context, the DICOM SERVER AE will select Transfer Syntaxes according to the following priority (highest priority first):

1. Explicit VR Little Endian
2. Implicit VR Little Endian
3. Explicit VR Big Endian

2.4 Communication Profiles

2.4.1 Supported Communication Stacks (parts 8)

DICOM Upper Layer (Part 8) is supported using TCP/IP.

2.4.2 TCP/IP Stack

The TCP/IP stack is inherited from a UNIX Operating System.

2.4.2.1 Physical Media Support

Ethernet v2.0, IEEE 802.3

2.4.3 Others

- DHCP is not supported.
- IPv6 is not supported.

2.5 Extensions / Specializations / Privatizations

2.5.1 Standard Extended Elements

Refer to Appendix A: *CT Image and Secondary Capture* for supported Standard Extended Elements.

2.5.2 Private Data Elements

Refer to Appendix B: *Private Data Elements* for a complete listing of private data elements used with this implementation

2.6 Configuration

2.6.1 AE Title/Presentation Address Mapping

The GEHC CT system allows the user to “add”, “Remove”, or “Update the mapping of remote AE Titles to IP Addresses and Ports. These options can be selected from “Network Configuration” dialog box displayed by choosing “Network Configuration” from the “Tools” pull-down menu from the local database browser.

2.6.2 Configurable Parameters

The following fields are configurable for this AE (local):

- Local AE Title
- Local IP Address
- Local Listening Port Number
- Local IP Netmask

Note: The local port on which the GEHC CT system receives DICOM incoming TCP connections is port **4006**.

The following fields are configurable for every Remote DICOM AE:

- Remote AE Title
- Remote IP Address
- Listening TCP/IP Port Number
- Max PDU length

The following fields are configurable:

- Association Establishment Timer time-out
- Store, Find, Move Timers time-out
- Inactivity, Echo Timers time-out
- Maximum PDU length

Note: Timeouts are set in network-cfg.xml and mergecom.pro files

Note: All configurations should be performed by a GE Field Service Engineer.

2.6.2.1 Print Configuration

The following fields are configurable for DICOM Print. The valid ranges are as described in Section 6.2

Attribute Name	DICOM Tag
Medium Type	(2000, 0030)
Film Destination	(2000, 0040)
Magnification Type	(2010, 0060)
Min Density	(2010, 0120)
Max Density	(2010, 0130)
Empty Image Density	(2010, 0110)
Border Density	(2010, 0100)
Configuration Information	(2010, 0150)
Smoothing Type	(2010, 0080)

The following network timers are supported and are configurable. When these timers expire the association is terminated. The default values are defined in dprint.cfg as below

Timeout Description	Default Value	Configuration Parameter Name
Association Time out	120 seconds	bi_assoc_tio
Session Time out	1200 seconds	bi_session_tio

Echo Time out	200 seconds	bi_echo_tio
N-SET Time out	300 seconds	bi_nset_tio
N-ACTION Time out	300 seconds	bi_naction_tio
N-CREATE Time out	300 seconds	bi_ncreate_tio
N-DELETE Time out	300 seconds	bi_ndelete_tio
N-GET Time out	100 seconds	bi_nget_tio

2.6.2.2 PPS Configuration

The parameters Remote MPPS AE IP Address, Remote AE(HIS/RIS) IP Port and Remote MPPS AE Title define where the MPPS requests will be directed.

The default value of Local AE Title is host name of the scanner appended with string “_PPS”. If the length exceeds 16 characters the AE Title is truncated to a length of 16.)

Configurable DICOM Data:

The following DICOM sequences are currently defaulted to be automatically sent in the PPS N-CREATE and PPS N-SET however PPS can be configured to not send them:

- (0008, 1032) Procedure Code Sequence – sent in the PPS N-CREATE. If not sent, the PPS N-CREATE will contain an empty Procedure Code Sequence.
- (0040, 0260) Performed Protocol Code Sequence – sent in the PPS N_SET. If not sent, the PPS N-SET will not contain a Performed Protocol Code Sequence.

The configuration is performed by GEHC Field Service Engineers changing parameters in configuration file *Dicom.cfg*

2.6.2.3 Modality Worklist Query Configuration

HIS/RIS is configured as a remote AE. These parameters define where worklist queries will be directed. Configuration of these parameters is performed by GEHC Field Service engineers using the ModalityWorklist installation facilities.

The following parameters are configurable for the DICOM Worklist Server AE:

- Local (Worklist Server) AE Title (automatically set to host name of scanner)
- Local IP address
- Local IP netmask
- Local IP gateway

The following parameters are configurable by changing their values in the configuration file **/usr/g/config/WLdcm.cfg**. Note that these parameters typically need not be changed. Furthermore, no support is provided for retaining changed settings: the values will require changing again after a system software upgrade.

- Implementation UID
- PDU size
- Association time-out period
- Session time-out period
- C-FIND time-out period

2.6.2.4 GSPS Configuration

The Exam Split feature is an option with two modes described in Section 8.2.

Exam Split allows for the configuration of the following parameters that pertain to the remote AE.

- | | |
|-----------------------------|---|
| • Remote GSPS AE IP Address | IP Address used to contact the remote GSPS AE |
| • Remote GSPS IP Port: | IP Port used to contact the remote GSPS AE |
| • Remote GSPS AE Title | Application Entity Title used to contact the remote GSPS AE |
| • Remote HES AE IP Address | IP Address used to contact the remote HES AE |
| • Remote HES IP Port: | IP Port used to contact the remote HES AE |
| • Remote HES AE Title | Application Entity Title used to contact the remote HES AE |

The following are configurable for the GSPS.

- Remote Host IP address
- Remote Host port
- Remote AE Title
- Changesplit_mode <HES/VES>

2.7 Support of Extended Character Sets

In addition to the DICOM default character set, GEHC CT supports the ISO IR 100 Latin alphabet #1 supplementary set for the purpose of interchange.

As a Storage SCP, the product will accept SOP Instances with any value of Specific Character Set (0008,0005).

As a Query SCU, it will similarly accept response items with any value of Specific Character Set. However, it will display in the user interface only characters specified as within ISO_IR 6 (ASCII) or the configured extended character set.

The product user interface will allow the user to enter characters from the console keyboard that is within ASCII or the configured extended character set. If any such extended characters are included

in SOP Instances or in query identifier matching fields, the product will appropriately specify the extended character set in Specific Character Set (0008,0005).

The generated MPPS messages will also specify the character set in (0008,0005) if the referenced images contain extended characters.

As a Modality Worklist SCU, it only uses ISO_IR 100 Specific Character Set in the worklist query requests.

2.8 Codes and Controlled Terminology

The product uses coded terminology as defined below.

2.8.1 Mapped Coded Terminology

The product maps, without change, coded terminology values supplied in Modality Worklist Scheduled Procedure Steps into Image SOP Instance and Modality Performed Procedure Step attributes, as described in Sections 6 and 7.

2.9 Security Profiles

The product does not conform to any defined DICOM Security Profiles.

It is assumed that the product is used within a secured environment. It is assumed that a secured environment includes at a minimum:

1. Firewall or router protections to ensure that only approved external hosts have network access to the product.
2. Firewall or router protections to ensure that the product only has network access to approved external hosts and services.
3. Any communications with external hosts and services outside the locally secured environment use appropriate secure network channels (such as a Virtual Private Network (VPN))

3 Media Storage Conformance Statement

3.1 Introduction

This conformance statement specifies the GEHC CT conformance to the DICOM Media Interchange. It details the DICOM Media Storage Application Profiles and roles that are supported by this product.

GEHC CT system provides capabilities to DICOM interchange on CD-R (Compact Disc - Recordable), CD-RW (Compact Disc - ReWritable), DVD-R (Digital Video Disc - Recordable), DVD-RW (Digital Video Disc - ReWritable) and USB (Universal Serial Bus) memory.

GEHC CT system works with most of the IOD's like Computed Tomography (CT), Magnetic Resonance (MR), Computed Radiography (CR), Positron Emission Tomography (PET), Digital X-Ray images, Structured Reporting (SR), X-Ray Dose SR, Grayscale Softcopy Presentation State (GSPS) and RT Structure Set.

3.2 Implementation Model

The DICOM Media Interchange Application Entity (AE) handles all DICOM media storage functionality on the GEHC CT system.

The DICOM Media Interchange AE is commanded to perform DICOM services through the buttons and menu selections on the user interface. It also uses the appropriate recorders to provide the service Interchange Media profiles.

3.2.1 Application Data Flow Diagram

The Basic and Specific Application models for the CD-R/CD-RW/DVD-R/DVD-RW/USB devices are shown in the following Illustration.

The DICOM Media Interchange Application Entity (AE) handles the DICOM CREATE (CD/DVD/USB) / RESTORE CD (USB) / QUERY CD (USB) functionality for the CD/DVD/USB media. The DICOM Media Interchange Application Entity (AE) is commanded by the user to perform DICOM services operating on the DICOM media through the use of buttons and menu selections on the graphical user interface of the platform.

The user requests the creation of a DICOM File Set and the writing of this DICOM File Set on blank Interchange Media by selecting images in the local Browser and selecting the Interchange Media as being the selected device. Then, the iso9660 image of the CD/DVD to burn will be generated. Once the generation has been done, it burns the complete set of data on the selected Interchange Media. For USB Storage media with VFAT filesystem, DICOM File Set is copied to blank Interchange media.

The Media Interchange Application Model for the GEHC CT system is shown in Illustration 3-1:.

Illustration 3-1: Specific AE Application Model

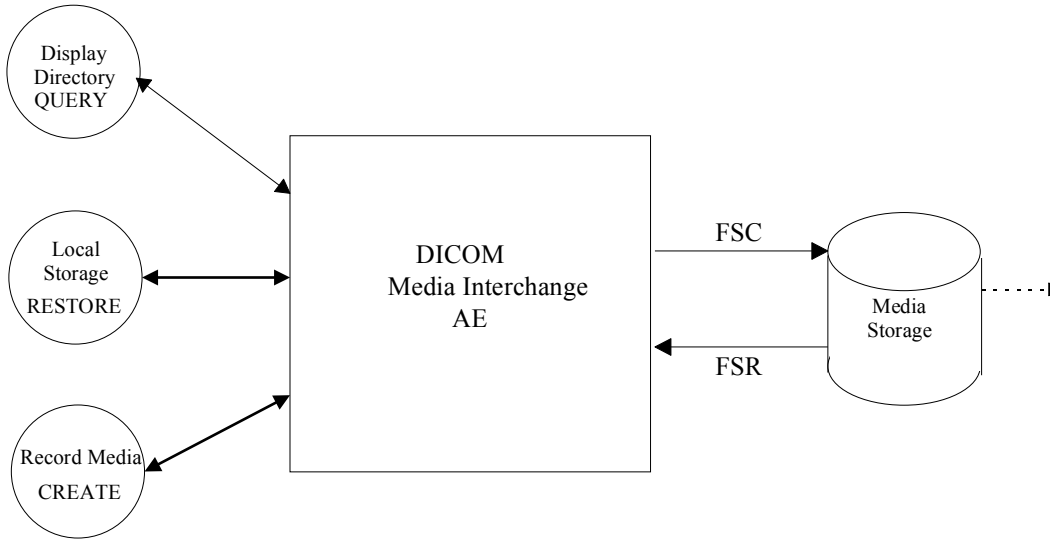

The DICOM Media Interchange AE has a local storage that may contain various SOP instances. These may have been obtained by original creation, network (DICOM or proprietary) or by removable media using other application entities. These instances are external to this conformance claim and the origin of SOP instances is outside the scope of this claim.

The DICOM Media Interchange AE initializes Media by acting as an FSC to create a new DICOM File-set on a 700MB CD/4.7GB DVD/USB Storage(no size limit) blank Interchange Media. . It initializes the DICOM File-set and writes all the specified SOP instances onto the Interchange Media at once. The SOP instances written will be limited to instances that match the criteria of one of the Application Profiles that is supported. Updating the media is not supported.

The DICOM Media Interchange AE acts as an FSR when requested to browse the Interchange Media such that user can select the SOP instances that he wants the DICOM Media Interchange AE to copy on the local database by selecting appropriate Study/Series/Image instances.

The supported file system during creation and restore are listed below:

TABLE 3.2.1-1

File System	Supported during Media Create (FSC)	Supported during Media Restore (FSR)
ISO 9660	YES	YES
UDF	NO	YES
VFAT	YES	YES

The supported media during creation and restore are listed below:

TABLE 3.2.1-2

Media	Supported during Media Create (FSC)	File System supported (FSC)	Supported during Media Restore (FSR)	File System supported (FSR)
CD -R	YES	ISO 9660	YES	ISO 9660
CD -RW	YES	ISO 9660	YES	ISO 9660
DVD -R	YES	ISO 9660	YES	ISO 9660 & UDF
DVD -RW	YES	ISO 9660	YES	ISO 9660 & UDF
USB Storage (VFAT file system)	YES	VFAT	YES	VFAT

3.2.2 Functional Definitions of AE's

The CD-R/ CD-RW/DVD-R/DVD-RW/USB DICOM Media Interchange Application Entity support the following functions:

- Generate and write a DICOM File Set (FSC) in a one shot activity. (CREATE).
- Read a DICOM File Set (FSR) on an Interchange Media (QUERY).
- It can copy SOP instances from the media onto local storage. (RESTORE).

3.2.3 Sequencing of Real World Activities

The display function (QUERY) can only be performed on a piece of media that already had a DICOM File-set created. With no SOP instances having been added, the directory will be displayed empty.

The write function (CREATE) can only be performed on a blank (unused) Interchange Media. Updates to an already recorded Interchange Medium are not supported.

There are no other sequencing requirements.

3.2.4 File Meta Information for Implementation Class and Version

The File Meta-Information for this implementation is:

- File Meta-Information Version.....1
- Implementation Version Name.....Software Revision (See Appendix D)

The table in Appendix D identifies the Implementation UID for this product version.

3.3 AE Specifications

3.3.1 DICOM CD-R/CD-RW/DVD-R/DVD-RW/USB Media Interchange AE Specification

The DICOM CD-R/CD-RW/DVD-R/DVD-RW/USB Media Interchange AE provides standard conformance to DICOM Media Storage Service Class. The Application Profiles and roles are listed in Table 3.3.1-1.

Table 3.3.1-1: Supported Application Profiles and Roles

Application Profiles Supported	Real World Activity	Role	SC Option
STD-GEN-CD	CREATE CD	FSC	Interchange
STD-GEN-CD	QUERY CD	FSR	Interchange
STD-GEN-CD	RESTORE CD	FSR	Interchange
STD-GEN-DVD-JPEG	CREATE DVD	FSC	Interchange
STD-GEN-USB-JPEG	CREATE USB	FSC	Interchange
STD-GEN-USB-JPEG	QUERY USB	FSR	Interchange
STD-GEN-USB-JPEG	RESTORE USB	FSR	Interchange

Note: JPEG compressed images are supported for USB restore only.

3.3.1.1 File Meta Information for the CD-R/CD-RW/DVD-R/DVD-RW/USB DICOM Media Interchange Application Entity

Following are the values set in the File Meta Information for this AE. Please refer to Appendix D: **Implementation UID for Product Versions** for details on specific GEHC CT system information.

- Implementation UID : See Appendix D
- Implementation version name : See Appendix D

3.3.1.2 Real World Activities for the CD-R/CD-RW/DVD-R/DVD-RW/USB DICOM Media Interchange Application Entity

3.3.1.2.1 Real World Activity: Record Media - CREATE (CD/DVD/USB)

The DICOM Media Interchange Application acts as an FSC using the interchange option when requested to copy SOP Instances from the local database to a CD-R / CD-RW / DVD-R / DVD-R / USB.

The user selects the entries in the local database that he/she wants the DICOM Media Interchange Application to copy onto Interchange Media.

The graphic interface allows the user to select the entries (studies, series or images) in the local database to be copied onto to the selected Interchange Media.

The DICOM Media Interchange Application creates one File Set per generated Interchange Media.

- The graphic interface allows the user to select the entries (studies, series or images) in the local database to be copied onto to the selected Interchange Media.

- A user cannot create CD/DVD/USB while restore CD/USB is in process.
- A DICOM Media Viewer is provided along with the selected object instances on the interchange media. This viewer can be loaded on a standard PC running Windows XP, Windows Vista or Windows 7.

Before writing on the Interchange Media, the DICOM Media Interchange Application checks for the following condition:

- The inserted media is blank and write-able. If the condition is not met, an error is displayed and the user needs to replace it with a blank media.

Note:

Since JPEG compression is not enabled, the transfer syntax for SOP Instances will always be Explicit VR Little Endian (ELE) Uncompressed Transfer Syntax, UID 1.2.840.10008.1.2.1. For any other IODs with Transfer syntax other than ELE, the corresponding SOP instance data are converted to ELE and then copied to CD/DVD/USB. During the conversion to ELE, the private tags are stored with VR as UN if the syntax is implicit to facilitate fidelity.

The Object SOP instances have to be encoded with the ISO_IR 100 Specific Character set or DICOM Default Character Set.

3.3.1.2.1.1 Application Profiles for the RWA: Record Media - CREATE (CD/DVD/USB)

Refer to Table 3.3.1-1 for the list of Application Profiles that invoke this AE for the Create CD/DVD/USB RWA.

Refer to Table 3.3.1.2.1.1-1 below for the SOP Classes supported by the RWA "Create CD/DVD/USB". All SOP Instances use the Explicit VR Little Endian Uncompressed Transfer Syntax, UID 1.2.840.10008.1.2.1 for creating CD/DVD/USB.

TABLE 3.3.1.2.1.1-1

SOP Class	SOP Class UID
CT Image Storage	1.2.840.10008.5.1.4.1.1.2
MR Image Storage	1.2.840.10008.5.1.4.1.1.4
PET Image Information Storage	1.2.840.10008.5.1.4.1.1.128
RT Structure Set Storage	1.2.840.10008.5.1.4.1.1.481.3
Secondary Capture Image Storage	1.2.840.10008.5.1.4.1.1.7
Grayscale Softcopy Presentation State Storage	1.2.840.10008.5.1.4.1.1.11.1
X-Ray Radiation Dose SR Image Storage	1.2.840.10008.5.1.4.1.1.88.67

Enhanced SR Storage	1.2.840.10008.5.1.4.1.1.88.22
---------------------	-------------------------------

3.3.1.2.1.1.1 Options for STD-GEN-C D Application Profile:

Refer TABLE 3.3.1.2.1.1-1 for SOP Classes supported by this AE.

Common DICOMDIR Directory Records created by this AE will include key attributes as described in **Appendix C - DICOMDIR Directory Information.**

The following Additional DICOMDIR keys are supported for this profile in IMAGE Directory Records.

Table 3.3.1.2.1.1.1-1 Additional DICOMDIR Keys for STD-GEN-CD

Key Attribute	Tag	Directory Record Type	Type	Notes
Image Type	(0008,0008)	IMAGE	1C	If present in composite object instances it will be set to same value, otherwise an error is returned.
Referenced Image Sequence	(0008,1140)	IMAGE	1C	If present in composite object instances it will be set to same value, otherwise an error is returned.
> Referenced SOP Class UID	(0008,1150)	IMAGE	1C	If present in composite object instances it will be set to same value, otherwise an error is returned.
> Referenced SOP Instance UID	(0008,1155)	IMAGE	1C	If present in composite object instances it will be set to same value, otherwise an error is returned.
Rows	(0028,0010)	IMAGE	3	If present in composite object instances it will be set to same value, otherwise not stored.
Columns	(0028,0011)	IMAGE	3	If present in composite object instances it will be set to same value, otherwise not stored.
Frame of Reference UID	(0020,0052)	IMAGE	3	If present in composite object instances it will be set to same value, otherwise not stored.
Image Position Patient	(0020,0032)	IMAGE	3	If present in composite object instances it will be set to same value, otherwise not stored.
Image Orientation Patient	(0020,0037)	IMAGE	3	If present in composite object instances it will be set to same value, otherwise not stored.
Pixel Spacing	(0028,0030)	IMAGE	3	If present in composite object instances it will be set to same value, otherwise not stored.

3.3.1.2.1.1.2 Options for STD-GEN-DVD-JPEG Application Profile:

Refer TABLE 3.3.1.2.1.1-1 for SOP Classes supported by this AE.

Common DICOMDIR Directory Records created by this AE will include key attributes as described in **Appendix C - DICOMDIR Directory Information.**

Following are the Additional DICOMDIR Keys supported for this profile:

Table 3.3.1.2.1.1.2-1 Additional DICOMDIR Keys for STD-GEN-DVD-JPEG

Key Attribute	Tag	Directory Record Type	Type	Notes
Patient's Birth Date	(0010,0030)	PATIENT	1C	If present in composite object instances it will be set to same value, otherwise not present
Patient's Sex	(0010,0040)	PATIENT	1C	If present in composite object instances it will be set to same value, otherwise not present
Institution Name	(0008,0080)	SERIES	1C	If present in composite object instances it will be set to same value, otherwise not sent
Institution Address	(0008,0081)	SERIES	1C	If present in composite object instances it will be set to same value, otherwise not sent
Performing Physician's Name	(0008,1050)	SERIES	1C	If present in composite object instances it will be set to same value, otherwise not sent
Image Type	(0008,0008)	IMAGE	1C	If present in composite object instances it will be set to same value, otherwise not sent
Calibration Image	(0050,0004)	IMAGE	1C	If present in composite object instances it will be set to same value, otherwise not sent
Referenced Image Sequence	(0008,1140)	IMAGE	1C	If present in composite object instances it will be set to same value, otherwise not sent
> Referenced SOP Class UID	(0008,1150)	IMAGE	1C	If present in composite object instances it will be set to same value, otherwise not sent
> Referenced SOP Instance UID	(0008,1155)	IMAGE	1C	If present in composite object instances it will be set to same value, otherwise not sent
Lossy Image Compression Ratio	(0028,2112)	IMAGE	1C	If present in composite object instances it will be set to same value, otherwise not sent
Rows	(0028,0010)	IMAGE	1	If present in composite object instances it will be set to same value, otherwise an error is returned

Columns	(0028,0011)	IMAGE	1	If present in composite object instances it will be set to same value, otherwise an error is returned
Frame of Reference UID	(0020,0052)	IMAGE	1C	If present in composite object instances it will be set to same value, otherwise not sent
Synchronization Frame of Reference UID	(0020,0200)	IMAGE	1C	If present in composite object instances it will be set to same value, otherwise not sent
Number of Frames	(0028,0008)	IMAGE	1C	If present in composite object instances it will be set to same value, otherwise not sent
Acquisition Time Synchronized	(0018,1800)	IMAGE	1C	If present in composite object instances it will be set to same value, otherwise not sent
Acquisition DateTime	(0008,002A)	IMAGE	1C	If present in composite object instances it will be set to same value, otherwise not sent
Image Position (Patient)	(0020,0032)	IMAGE	1C	If present in composite object instances it will be set to same value, otherwise not sent
Image Orientation (Patient)	(0020,0037)	IMAGE	1C	If present in composite object instances it will be set to same value, otherwise not sent
Pixel Spacing	(0028,0030)	IMAGE	1C	If present in composite object instances it will be set to same value, otherwise not sent

3.3.1.2.1.1.3 Options for STD-GEN-USB-JPEG Application Profile:

Refer TABLE 3.3.1.2.1.1-1 for SOP Classes supported by this AE.

Common DICOMDIR Directory Records created by this AE will include key attributes as described in **Appendix C - DICOMDIR Directory Information.**

Following are the Additional DICOMDIR Keys supported for this profile:

Table 3.3.1.2.1.1.3-1 Additional DICOMDIR Keys for STD-GEN-USB-JPEG

Key Attribute	Tag	Directory Record Type	Type	Notes
Patient's Birth Date	(0010,0030)	PATIENT	1C	If present in composite object instances it will be set to same value, otherwise not sent

Patient's Sex	(0010,0040)	PATIENT	1C	If present in composite object instances it will be set to same value, otherwise not sent
Institution Name	(0008,0080)	SERIES	1C	If present in composite object instances it will be set to same value, otherwise not sent
Institution Address	(0008,0081)	SERIES	1C	If present in composite object instances it will be set to same value, otherwise not sent
Performing Physician's Name	(0008,1050)	SERIES	1C	If present in composite object instances it will be set to same value, otherwise not sent
Image Type	(0008,0008)	IMAGE	1C	If present in composite object instances it will be set to same value, otherwise not sent
Calibration Image	(0050,0004)	IMAGE	1C	If present in composite object instances it will be set to same value, otherwise not sent
Referenced Image Sequence	(0008,1140)	IMAGE	1C	If present in composite object instances it will be set to same value, otherwise not sent
> Referenced SOP Class UID	(0008,1150)	IMAGE	1C	If present in composite object instances it will be set to same value, otherwise not sent
> Referenced SOP Instance UID	(0008,1155)	IMAGE	1C	If present in composite object instances it will be set to same value, otherwise not sent
Lossy Image Compression Ratio	(0028,2112)	IMAGE	1C	If present in composite object instances it will be set to same value, otherwise not sent
Rows	(0028,0010)	IMAGE	1	If present in composite object instances it will be set to same value, otherwise an error is returned
Columns	(0028,0011)	IMAGE	1	If present in composite object instances it will be set to same value, otherwise an error is returned
Frame of Reference UID	(0020,0052)	IMAGE	1C	If present in composite object instances it will be set to same value, otherwise not sent
Synchronization Frame of Reference UID	(0020,0200)	IMAGE	1C	If present in composite object instances it will be set to same value, otherwise not sent
Number of Frames	(0028,0008)	IMAGE	1C	If present in composite object instances it will be set to same value, otherwise not sent

Acquisition Time Synchronized	(0018,1800)	IMAGE	1C	If present in composite object instances it will be set to same value, otherwise not sent
Acquisition DateTime	(0008,002A)	IMAGE	1C	If present in composite object instances it will be set to same value, otherwise not sent
Image Position (Patient)	(0020,0032)	IMAGE	1C	If present in composite object instances it will be set to same value, otherwise not sent
Image Orientation (Patient)	(0020,0037)	IMAGE	1C	If present in composite object instances it will be set to same value, otherwise not sent
Pixel Spacing	(0028,0030)	IMAGE	1C	If present in composite object instances it will be set to same value, otherwise not sent

3.3.1.2.1.1.4 FSC Directory Options

Refer to Appendix C: **DICOMDIR Directory Information** for a complete listing of all modules and attributes used in the DICOMDIR definition.

NOTE:

Modality attribute (0008,0060) in the DICOMDIR Series records should be “CT” for Secondary Capture SOP Class Images. Otherwise the GEHC CT system’s DICOM media display browser will not list-up the series for contents rendering the retrieval to local storage impossible.

For USB, only one DICOM file set shall be stored in the first partition of a partitioned device. If the device is not partitioned, only one DICOM file set shall be stored on the device.

3.3.1.2.2 Real World Activity: Display Directory – QUERY (CD/USB)

The DICOM Media Interchange AE acts as an FSR using the interchange option when requested to browse the Interchange Media.

When the DICOM Media Interchange AE is requested to provide a directory listing, it reads the File-set and displays the DICOMDIR directory entries, according to the STUDY Root paradigm.

If the media is not blank, then Interchange Media gets mounted. To remove the media, the user has to select the eject button on user interface for the appropriate drive.

A user cannot display the directory when create CD/DVD/USB or restore CD/USB are in progress.

3.3.1.2.2.1 Application Profiles for the RWA: Display Directory

For the list of Application Profiles that invoke this AE for the Display Directory CD/USB RWA,, see Table 3.3.1-1.

There are no extensions or specializations.

3.3.1.2.2.2 Media Storage Application Profile for the RWA: Display Directory:

Following are the SOP Classes supported by the RWA “Display Directory of CD/USB”:

Information Object Definition	SOP Class UID	Transfer Syntax	Transfer Syntax UID
Media Storage Directory Storage	1.2.840.10008.1.3.10	Explicit VR Little Endian	1.2.840.10008.1.2.1

3.3.1.2.3 Real World Activity (RWA): Local Storage – RESTORE (CD/USB)

The CD/USB DICOM Media Interchange AE acts as an FSR using the interchange option when requested to copy SOP instances from the CD/USB to the local database.

The user selects the SOP instances that he wants the DICOM Media Interchange AE to copy on the local database by selecting appropriate Study/Series/Image instances and clicking on the suitable restore buttons. Once selected, the SOP instances are copied from the media to the local database.

If the media is not blank, then the Interchange Media gets mounted. To remove the media, the user has to select the eject button on the User Interface for the appropriate drive.

A user cannot restore CD/USB while create CD/DVD/USB is in process.

A user can only restore selected composite objects at a time from a media; any other attempt of selections to restore CD/USB on media in same drive will wait until the first one is completed.

3.3.1.2.3.1 Application Profiles for the RWA: Local Storage – RESTORE (CD/USB)

For the list of Application Profiles that invoke this AE for the Restore RWA, see Table 3.3.1-1. For extensions and specialization’s see section 3.5.

3.3.1.2.3.1.1 Options for STD-GEN-CD and STD-GEN-USB-JPEG Application Profile:

Common DICOMDIR Directory Records read by this AE will include key attributes as described in Appendix C.

Following are the SOP Classes supported by the RWA “Local Storage – RESTORE (CD/USB)”.

Information Object	SOP Class UID	Transfer Syntax	Transfer Syntax UID
--------------------	---------------	-----------------	---------------------

Definition			
Media Storage Directory Storage	1.2.840.10008.1.3.10	Explicit VR Little Endian	1.2.840.10008.1.2.1
See Table 3.3.1.2.1.1-1	See Table 3.3.1.2.1.1-1	Explicit VR Little Endian	1.2.840.10008.1.2.1
See Table 3.3.1.2.1.1-1	See Table 3.3.1.2.1.1-1	JPEG Lossless Process 14 (selection value 1) (STD-GEN-USB-JPEG only)	1.2.840.10008.1.2.4.70
See Table 3.3.1.2.1.1-1	See Table 3.3.1.2.1.1-1	JPEG Lossy, Baseline Sequential with Huffman Coding (Process 1) (STD-GEN-USB-JPEG only)	1.2.840.10008.1.2.4.50
See Table 3.3.1.2.1.1-1	See Table 3.3.1.2.1.1-1	JPEG Extended (Process 2 & 4): Default Transfer Syntax for Lossy JPEG 12 Bit Image Compression (Process 4 only) (STD-GEN-USB-JPEG only)	1.2.840.10008.1.2.4.51

3.4 Augmented and Private Application Profiles

3.4.1 Augmented Application Profiles

The CD/DVD/USB Media Archive Interchange AE does not support any augmented Application Profiles.

3.4.2 Private Application Profiles

The CD/DVD/USB Media Interchange AE does not support any private Application Profiles

3.5 Extensions, Specializations and Privatization of SOP Classes and Transfer Syntax

3.5.1 Extensions, Specialization's and Privatizations of SOP Classes

The CT/MR SOP Class Images have definitions extended for Defined Terms and include GE specific Private Data elements. The following sections describe the details for these SOP classes.

3.5.1.1 SOP Specific Conformance Statement for Basic Directory SOP Class

Following attributes are Standard extensions for each Directory Record type.

Key Attribute	Tag	Directory Record Type
Image Type	(0008,0008)	SERIES IMAGE
Manufacturer's ID	(0008,0070)	SERIES
Series Description	(0008,103E)	SERIES
Manufacturer's Model Name	(0008,1090)	SERIES
SOP Instance UID	(0008,0018)	IMAGE PRESENTATION SR DOCUMENT
Acquisition Time	(0008,0032)	IMAGE
Slice Thickness	(0018,0050)	IMAGE
Spacing Between Slices	(0018,0088)	IMAGE
Data Collection Diameter	(0018,0090)	IMAGE
Reconstruction Diameter	(0018,1100)	IMAGE
Gantry/Detector Tilt	(0018,1120)	IMAGE
Convolution Kernel	(0018,1210)	IMAGE
Slice Location	(0020,1041)	IMAGE

Refer to Appendix B: *Private Data Elements* for private data elements.

3.5.2 Private Transfer Syntax Specification

None specified.

3.6 Configuration

For the CD/DVD/USB Interchange Media Application, the source AE Title encoded in the File Meta-Information cannot be modified.

3.7 Support of Extended Character Sets

The CD/DVD/USB Interchange Media Application will support copy of SOP instances containing the ISO IR 100 (Latin alphabet No. 1, supplementary set) and DICOM default character sets as defined in PS3.5.

Any incoming SOP instances encoded using another extended character set will not be installed in the GEHC CT system database

3.8 IHE Integration

3.8.1 IHE PDI

The CT system supports the Integrating the Healthcare Enterprise (IHE) Portable Data for Imaging (PDI) Profile as Portable Media Creator actor.

Table 3.8.1-1 lists the IHE PDI profile options supported by Portable Media Creator.

Table 3.8.1-1 Support of IHE PDI profile as Portable Media Creator

Option	Support
Write to DVD Media	Yes
Write to USB Media	Yes
Add Basic Viewer	Yes
Media Labeling	Yes
Privacy Protection	No
Sending Software	No
WEB Content	No

4 Print Management Implementation

4.1 Introduction

This section of conformance Statement specifies the implementation for the specific SOP Classes supported in the Basic Grayscale and Color Print Management Meta SOP Classes, the attributes supported for both IODs and services, and the valid range of values for mandatory and optional attributes.

4.2 Basic Film Session SOP Class

The Print SCU supports the following DIMSE Service Elements for the Basic Film Session SOP Class.

- N-CREATE – Requests the Print SCP to create an instance of Basic Film Session.

4.2.1 Basic Film Session N-Create Attributes

The following Attribute values are supported by the N-CREATE:

Attribute name	Tag	Use
Specific Character Set	(0008,0005)	Not used
*Number of Copies	(2000,0010)	Set by user. Valid range is : 1-99
*Print Priority	(2000,0020)	Set when a printer device is added using the Film Composer Tool. Default value is HIGH. Set in Configuration file Valid Range is : HIGH or MED or LOW
*Medium Type	(2000,0030)	Set when a printer device is added using the Film Composer Tool. Set in Configuration File Valid values are : PAPER or CLEAR FILM or BLUE FILM
*Film Destination	(2000,0040)	Set when a printer device is added using the Film Composer Tool. Set in Configuration File Valid values are : MAGAZINE or PROCESSOR
Film Session Label	(2000,0050)	Not used.
Memory Allocation	(2000,0060)	Not used.
Owner ID	(2100,0160)	Not used.

Note: * denotes that the attribute is optional for the SCU. However, we do provide values for all of these optional attributes and if the SCP does not support the requested value it may choose to either return a failure status or ignore the value provided and use its default value.

4.3 Basic Film Box SOP Class

The Print SCU supports the following DIMSE Service Elements for the Basic Film Box SOP Class.

- N-CREATE – Requests the Print SCP to create an instance of Film Box.
- N-ACTION – Requests the Print SCP to print the Film Box onto Printer.
- N-DELETE – Requests the Print SCP to delete the Film Box Instance.

4.3.1 Basic Film Box N-Create Attributes

This table lists the attributes that are sent to the SCP in the Basic Film Box N-Create Request, and that are received in the Basic Film Box N-Create Response from the SCP

Attribute Name	Tag	Use
Image Display Format	(2010,0010)	Set in User Interface. Valid Range: STANDARD\C,R
Referenced Film Session Sequence	(2010,0500)	Sent in the request
>Referenced SOP Class UID	(0008,1150)	Film session SOP Class UID (1.2.840.10008.5.1.1.1)
>Referenced SOP Instance UID	(0008,1155)	Film session SOP instance UID
Referenced Image Box Sequence	(2010,0510)	Used in Image Box N-SET request
>Referenced SOP Class UID	(0008,1150)	
>Referenced SOP Instance UID	(0008,1155)	
*Film Orientation	(2010,0040)	Set when a printer device is added using the Film Composer Tool. Set in Configuration File. Valid value is : PORTRAIT.
Film Size ID	(2010,0050)	Set when a printer device is added using the Film Composer Tool. Valid values are : 14INX17IN, A3, A4, 8INX10IN, 8.5INX11IN, 10INX12IN, 10INX14IN, 11INX14IN, 11INX17IN, 14INX14IN, 24CMX24CM, 24CMX30CM.
*Magnification Type	(2010,0060)	Set when a printer device is added using the Film Composer Tool. Set in Configuration File. Valid values are: REPLICATE

		BILINEAR CUBIC NONE
*Max Density	(2010,0130)	Set when a printer device is added using the Film Composer Tool. Set in Configuration File. Valid range is : 0-4095.
Configuration Information	(2010,0150)	Set when a printer device is added using the Film Composer Tool
Annotation Display Format ID	(2010,0030)	Not Supported.
*Smoothing Type	(2010,0080)	Set when a printer device is added using the Film Composer Tool. Set in Configuration File.
*Border Density	(2010,0100)	Set when a printer device is added using the Film Composer Tool. Set in Configuration File. Valid values are: BLACK or WHITE or Not sent
*Empty Image Density	(2010,0110)	Set when a printer device is added using the Film Composer Tool. Set in Configuration File. Valid values are: BLACK or WHITE or Not sent
*Min Density	(2010,0120)	Set when a printer device is added using the Film Composer Tool. Set in Configuration File. Valid values are: 0-4095 or Not sent
*Trim	(2010,0140)	Valid values are: YES or NO or Not Sent Default value : NO
Illumination	(2010,015E)	Not Supported.
Reflected Ambient Light	(2010,0160)	Not Supported.
Requested Resolution ID	(2020,0050)	Not Supported.
ICC Profile	(0028,2000)	Not Supported.

4.3.2 Basic Film Box N-Action Attributes

Following are the Action reply arguments that are supported if present in the N-Action response of the Basic Film Box SOP Class

Action Type Name	Action Type ID	Attribute	Tag	Usage SCU
Print	1	Referenced Print Job Sequence	(2100,0500)	Ignored
		>Referenced SOP Class UID	(0008,1150)	Ignored
		>Referenced SOP Instance UID	(0008,1155)	Ignored
		>Print Job ID	(2100,0010)	Not supported

4.3.3 Basic Film Box N-Delete

The DICOM SERVER AE requests the Print SCP to delete the Film Box Instance.

Note: * denotes that the attribute is optional for the SCU. However, we do provide values for all of these optional attributes and if the SCP does not support the requested value it may choose to either return a failure status or ignore the value provided and use its default value.

4.4 Basic Grayscale Image Box SOP Class

The Print SCU supports the following DIMSE Service Elements for Grayscale Image Box SOP Class.

- N-SET – Requests the Printer to set the image box attributes.

This table lists the attributes that are sent in the Basic Grayscale Image Box N-Set Request:

Attribute Name	Tag	Use
Image Position	(2020,0010)	Based on Image Display Format
Basic Grayscale Image Sequence	(2020,0110)	Sent in the request
>Samples Per Pixel	(0028,0002)	1
>Photometric Interpretation	(0028,0004)	MONOCHROME2
>Rows	(0028,0010)	Image Dependent
>Columns	(0028,0011)	Image Dependent
>Pixel Aspect Ratio	(0028,0034)	1\1
>Bits Allocated	(0028,0100)	8 (if Bits Stored=8) or 16 (if Bits Stored=12)
>Bits Stored	(0028,0101)	8 or 12. Default value: 8
>High Bit	(0028,0102)	7 (if Bits Stored=8) or 11 (if Bits Stored=12)
>Pixel Representation	(0028,0103)	0 (unsigned integer)
>Pixel Data	(7FE0,0010)	Pixel data

*Polarity	(2020,0020)	NORMAL
Magnification Type	(2010,0060)	BILINEAR CUBIC REPLICATE NONE
Smoothing Type	(2010,0080)	Printer Dependent
Min Density	(2010,0120)	0-4095, Not Sent
Max Density	(2010,0130)	0-4095
Configuration Information	(2010,0150)	Printer Dependent
Requested Image Size	(2020,0030)	Not used
Requested Decimate/Crop Behavior	(2020,0040)	Not used
Referenced Presentation LUT Sequence	(2050,0500)	Not supported.
> Referenced SOP Class UID	(0008,1150)	Not supported.
> Referenced SOP Instance UID	(0008,1155)	Not supported.

Note: * denotes that the attribute is optional for the SCU. However, we do provide values for all of these optional attributes and if the SCP does not support the requested value it may choose to either return a failure status or ignore the value provided and use its default value.

4.5 Basic Color Image Box SOP Class

The Print SCU supports the following DIMSE Service Elements for Basic Color Image Box SOP Class.

- N-SET - Requests the Printer to set the image box attributes.

This table lists the attributes that are sent in the Basic Color Image Box N-Set Request:

Attribute Name	Tag	Use
Image Position	(2020,0010)	Based on Image Display Format
Basic Color Image Sequence	(2020,0111)	
>Samples Per Pixel	(0028,0002)	3
>Photometric Interpretation	(0028,0004)	RGB
>Planar Configuration	(0028,0006)	1
>Rows	(0028,0010)	Image Dependent
>Columns	(0028,0011)	Image Dependent
>Pixel Aspect Ratio	(0028,0034)	1/1
>Bits Allocated	(0028,0100)	8
>Bits Stored	(0028,0101)	8
>High Bit	(0028,0102)	7
>Pixel Representation	(0028,0103)	0 (unsigned integer)

>Pixel Data	(7FE0,0010)	Pixel data
*Polarity	(2020,0020)	NORMAL
Magnification Type	(2010,0060)	BILINEAR CUBIC REPLICATE NONE
Smoothing Type	(2010,0080)	Printer Dependent
Requested Image Size	(2020,0030)	Not used
Requested Decimate/Crop Behavior	(2020,0040)	Not used

4.6 Printer SOP Class

N-GET DIMSE service is supported for the Printer SOP Class. If an N-EVENT-REPORT DIMSE service is received when the association is active, Print SCU handles the relevant states but the data received is ignored.

This table defines the set of attributes that this product may request using the Printer N-Get service. It also describes the product behavior when receiving the N-Get response from the Printer SCP:

Attribute Name	Tag	Use
Printer Status	(2110,0010)	NORMAL: Status is logged and sends Film Session N-CREATE request. WARNING: Status is logged. Pauses the print job and displays status code on the film composer UI. FAILURE: Status is logged. Pauses the print job and displays print failure message on the film composer UI.
Printer Status Info	(2110,0020)	SUPPLY LOW: Logs the message and continues printing. SUPPLY EMPTY: print job is paused and the message is logged. RECEIVER FULL: print job is paused and the message is logged. FILM JAM: print job is paused and the message is logged.
Printer Name	(2110,0030)	Logged if sent by SCP
Manufacturer	(0008,0070)	Logged if sent by SCP
Manufacturer Model Name	(0008,1090)	Logged if sent by SCP

Device Serial Number	(0018,1000)	Logged if sent by SCP
Software Versions	(0018,1020)	Logged if sent by SCP
Date Of Last Calibration	(0018,1200)	Ignored
Time Of Last Calibration	(0018,1201)	Ignored

5 Storage Commitment Push Model Implementation

5.1 Storage Commitment Push Model Information Object Definition

Please refer to DICOM Part 3 (Information Object Definitions) for a description of each of the attributes contained within the Storage Commitment Information Object.

The Storage Commitment Information Object is used both for N-ACTION Storage Commitment Requests and N-EVENT-REPORT Storage Commitment Notifications by the SCU.

5.1.1 Storage Commitment Module for N-ACTION

Table – 5.1.1-1 Storage Commitment Module for N-ACTION

Attribute Name	Tag	SCU Use
Transaction UID	(0008,1195)	Generated for each retry
Storage Media File-Set ID	(0088,0130)	Not supported
Storage Media File-Set UID	(0088,0140)	Not supported
Referenced SOP Sequence	(0008,1199)	
>Referenced SOP Class UID	(0008,1150)	
>Referenced SOP Instance UID	(0008,1155)	
>Storage Media File-Set ID	(0088,0130)	Not supported
>Storage Media File-Set UID	(0088,0140)	Not supported

5.1.2 Storage Commitment Module for N-EVENT-REPORT

Table – 5.1.2-1 Storage Commitment Module for N-EVENT-REPORT

Attribute Name	Tag	SCU Use
Transaction UID	(0008,1195)	Value received from SCP
Retrieve AE Title	(0008,0054)	Not used
Storage Media File-Set ID	(0088,0130)	Not used
Storage Media File-Set UID	(0088,0140)	Not used
Referenced SOP Sequence	(0008,1199)	When status is SUCCESS, the “Archived” flag value for the referenced SOP instances is changed to “Yes” in the browser. In case of partial failure, the archival status of a series is updated only if all the images of the series are archived successfully. Archive status of series is not updated if archiving of one or more images of the series failed. Image level archive status updation is not supported.

>Referenced SOP Class UID	(0008,1150)	
>Referenced SOP Instance UID	(0008,1155)	
>Retrieve AE Title	(0008,0054)	Not used.
>Storage Media File-Set ID	(0088,0130)	Not used
>Storage Media File-Set UID	(0088,0140)	Not used
Failed SOP Sequence	(0008,1198)	"Archived" flag value for the failed SOP instance is unaltered. Failed SOP instances are logged.
>Referenced SOP Class UID	(0008,1150)	
>Referenced SOP Instance UID	(0008,1155)	
>Failure Reason	(0008,1197)	Not used.

5.1.2.1 **Processing of Failure Reason when received in a N-Event-Report**

When receiving a N-Event-Report request with Event Type ID equal to 2, meaning that Storage Commitment is complete, but failure exists, following is the set of value that this Storage Commitment SCU AE is able to process.

Failure Reason	Meaning	Application Behavior When Receiving Reason Code
0110H	Processing failure	Log file updated: Processing Failure. Job failed.
0112H	No such object instance	Log file updated: No such object instance. Job failed.
0213H	Resource limitation	Log file updated: resource limitation. Job failed.
0122H	Referenced SOP Class not supported	Log file updated: reference SOP class not supported. Job failed.
0119H	Class / Instance conflict	Log file updated: class/instance conflict. Job failed.
0131H	Duplicate transaction UID	Log file updated: duplicate transaction UID. Job failed.
*	Other Failure Reason code values	Log file updated: unknown failure. Job failed.

6 Modality Worklist Query Implementation

6.1 Modality Worklist Information Model Definition

6.1.1 Introduction

This section specifies the use of the DICOM Modality Worklist Information Model used to organize data and against which a Modality Worklist Query will be performed.

6.1.2 Modality Worklist Information Model Description

In order to serve as a Service Class Provider (SCP) of the Modality Worklist Service Class, a DICOM Application Entity (AE) possesses information about the attributes of a number of managed worklist items. These items are organized into Modality Worklist Information Modules. In this Service Class, the Information Model plays a role similar to an Information Object Definition of most other DICOM Service Classes.

6.1.3 Modality Worklist Information Model Entity-Relationship Model

The Entity-Relationship diagram for the Modality Worklist Information Model schema is shown in Illustration 6.1.3-1. It represents the information that composes a Worklist Item. In this figure, the following diagrammatic convention is established to represent the information organization:

- Each entity is represented by a rectangular box
- Each relationship is represented by a diamond shaped box.
- The fact that a relationship exists between two entities is depicted by lines connecting the corresponding entity boxes to the relationship boxes.

Illustration 6.1.3-1 – Modality Worklist Information Model E/R DIAGRAM

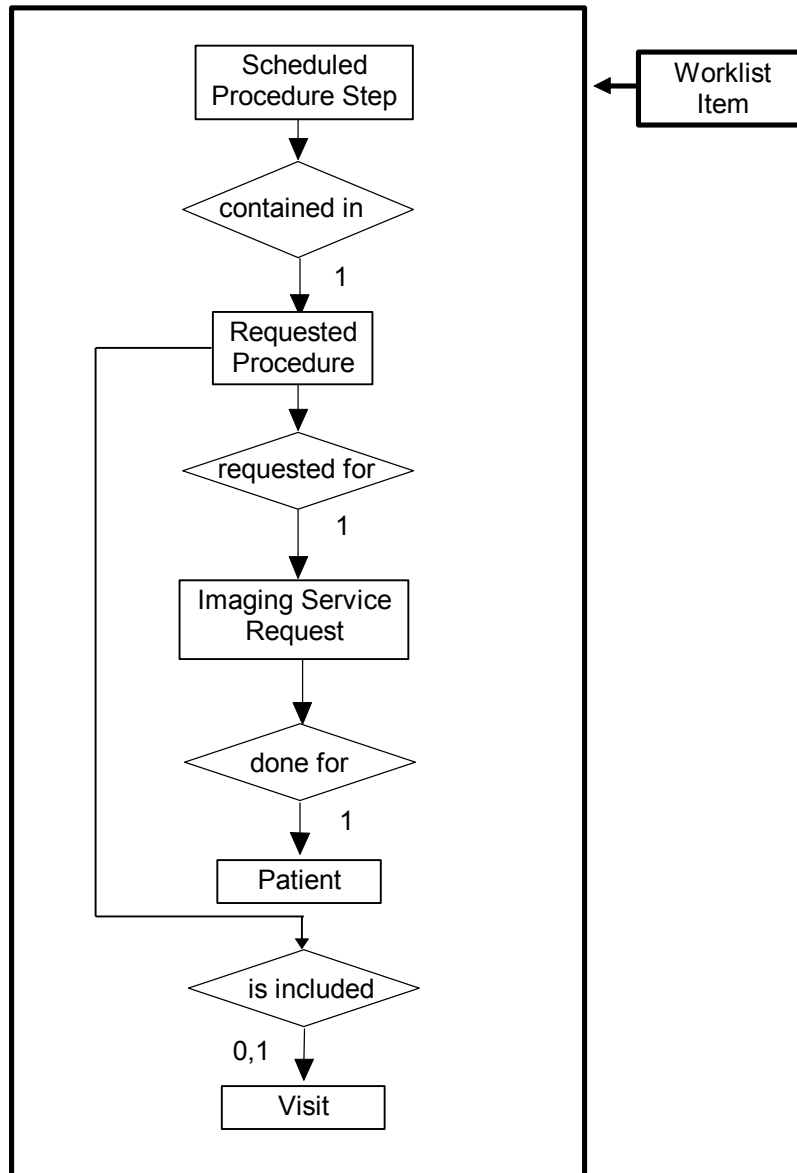

6.1.3.1 Entity Descriptions

Please refer to DICOM Standard PS 3.3. (Information Object Definitions) and PS 3.4 (Service Class Specifications) for a description of each of the Entities contained within the Modality Worklist Information Model.

6.1.3.1.1 Scheduled Procedure Step

A Scheduled Procedure Step is an arbitrarily defined scheduled unit of service that is specified by the Procedure Plan for a Requested Procedure. It specifies one or more Action Items (events) involving equipment (i.e. imaging modality equipment), human resources, location and time (i.e. start time, stop time, duration).

6.1.3.1.2 Requested Procedure Entity Description

A Requested Procedure is an instance of a Procedure of a given Procedure Type. An instance of a Requested Procedure includes all of the items of information that are specified by an instance of a Procedure Plan that is selected for the Requested Procedure by the imaging service provider.

6.1.3.1.3 Imaging Service Request Entity Description

An Imaging Service Request is a set of one or more Requested Procedures selected from a list of Procedure Types. An Imaging Service Request is submitted by one authorized imaging service requester to one authorized imaging service provider in the context of one Service Episode.

6.1.3.1.4 Visit Entity Description

A Visit is the context in which the treatment or management of an arbitrary subset of a Patient's medical conditions occurs. A Visit is limited to the description of a Patient's activities at a single facility.

6.1.3.1.5 Patient Entity Description

A Patient is a person receiving, or registered to receive healthcare services.

6.1.4 ModalityWorklist Mapping of DICOM Entities

Table 6.1.4-1 —Mapping of DICOM Entities to ModalityWorklist Entities

DICOM	ModalityWorklist Entity
Scheduled Procedure Step	Exam
Requested Procedure	Exam
Imaging Service Request	Exam
Visit	Exam
Patient	Patient

6.1.5 Modality Worklist Information Model Module

Within an entity of the DICOM Modality Worklist Information Model, attributes are grouped together into related set of attributes called modules. A module facilitates the understanding of the semantics concerning the attributes and how the attributes relate to one another. A module grouping does not infer any encoding of information into datasets.

Table 6.1.5-1 identifies the defined modules within the entities that comprise the DICOM Modality Worklist Information Model. Modules are identified by Module Name.

See DICOM PS 3.3 and PS 3.4 for a complete definition of the entities, modules, and attributes.

Table 6.1.5-1 – Modality Worklist Information Model Modules

Entity Name	Module Name	Reference
Scheduled Procedure Step	SOP Common	6.1.6.2.1
	Scheduled Procedure Step	6.1.6.2.2
Requested Procedure	Requested Procedure	6.1.6.3.1
Imaging Service Request	Imaging Service Request	6.1.6.4.1
Visit	Visit Identification	6.1.6.5.1
	Visit Status	6.1.6.5.2
	Visit Relationship	6.1.6.5.3
	Visit Admission	6.1.6.5.4
Patient	Patient Relationship	6.1.6.6.1
	Patient Identification	6.1.6.6.2
	Patient Demographic	6.1.6.6.3
	Patient Medical	6.1.6.6.4

6.1.6 Information Model Keys

Please refer to DICOM Standard PS 3.3. (Information Object Definitions) and PS 3.4 (Service Class Specifications) for a description of each of the Entities contained within the Modality Worklist Information Model.

The following Module descriptions contain the attributes that are present in a C-FIND request message sent by the Worklist Server AE to a remote AE. It should be noted that they are the same as those defined in the DICOM Standard, PS 3.4 (Service Class Specifications) and include:

- **Attribute Name**
- **Tag:** group and element numbers
- **Expected Matching Key Type:** R-required, O-optional
- **Expected Return Key Type:**
 - 1 - non-zero value required
 - 1C - conditionally of type 1
 - 2 - required to be present, possibly with zero-length value
 - 3 - optional
- **Mapped into The Image:** whether this data is mapped into subsequently acquired images
- **Notes:** clarification of this implementation's use/treatment of this attribute

All data elements in the following Module descriptions are requested by the Worklist Server AE. Values of data elements that are not mapped into images, and are not otherwise dealt with (displayed on the user interface, etc.), are not used and are, thus, discarded upon receipt. See Table B-1 for further information.

Data elements for which values can be sent for matching purposes are described as such. Data elements for which values are not sent are sent with zero length and universal matching will apply. This is the default case if no other description to the contrary is provided.

6.1.6.1 Supported Matching

The following are the types of matching that can be request by the implementation:

- Single Value matching
- Universal Matching
- Range of date/time

6.1.6.2 Scheduled Procedure Step Entity

6.1.6.2.1 SOP Common Module

Table 6.1.6.2.1-1 – SOP Common Module Attributes

Attribute Name	Tag	Expected Matching Key Type	Expected Returned Key Type	Mapped into the Image/MPPS	Note
Specific Character Set	(0008,0005)	O	1C	No/No	This value is always sent. ISO_IR_100 is the default value sent during querying if not set explicitly. Product uses the value returned if it is set in the response.

6.1.6.2.2 Scheduled Procedure Step Module

Table 6.1.6.2.2-1 – Scheduled Procedure Step Module Attributes

Attribute Name	Tag	Expected Matching Key Type	Expected Returned Key Type	Mapped into the Image/MPPS	Note
Scheduled Procedure Step Sequence	(0040,0100)	R	1	No/No	Requested in the MWL queries.
Scheduled Station AE Title	(0040,0001)	R	1	No/No	Matching is supported as follows: either no AE title is supplied (universal matching), or the scanner’s Worklist Server AE title is supplied for matching; this is user selectable.

Scheduled Procedure Step Start Date	(0040,0002)	R	1	No/No	Matching is supported as one of the following; this is user selectable: <ul style="list-style-type: none"> • all days, • today only, • today and a number of days before today, • today and a number of days after today, • today and a number of days before today and a number of days after today. Number of days before/after is specified by the user. Returned values must be exactly 8 numeric characters in YYYYMMDD format.
Scheduled Procedure Step Start Time	(0040,0003)	R	1	No/No	This attribute is sent with zero-length. Returned values must be exactly 6 numeric characters in HHMMSS format.
Modality	(0008,0060)	R	1	Yes/Yes	Matching is supported as follows: either no Modality is supplied (universal matching), or the scanner's Modality is supplied for matching; this is user selectable.
Scheduled Performing Physician's Name	(0040,0006)	R	2	Yes/Yes	This attribute is sent with zero-length. This value is mapped into (0008, 1050) in the image header and in MPPS.
Scheduled Procedure Step Description	(0040,0007)	O	1C	Yes/Yes	
Scheduled Station Name	(0040,0010)	O	2	No/No	
Scheduled Procedure Step Location	(0040,0011)	O	2	No/No	
Scheduled Protocol Code Sequence	(0040,0008)	O	1C	Yes/Yes	Up to 5 Scheduled Protocol Code Sequence Items are mapped into the image if they system is configured to support GSPS.
Code Value	(0008,0100)	O	1C	Yes/No	
Coding Scheme Designator	(0008,0102)	O	1C	Yes/No	
Code Meaning	(0008,0104)	O	3	Yes/No	NOTE: though type 3, the scanner expects Code Meaning to be sent if (0040,0008) is sent.
Pre-Medication	(0040,0012)	O	2C	No/No	

Scheduled Procedure Step ID	(0040,0009)	O	1	Yes/Yes	
Requested Contrast Agent	(0032,1070)	O	2C	No/No	Displayed on "More Info..." screen.

6.1.6.3 Requested Procedure Entity

6.1.6.3.1 Requested Procedure Module

Table 6.2.6.3.1-1 Requested Procedure Module Attributes

Attribute Name	Tag	Expected Matching Key Type	Expected Returned Key Type	Mapped into the Image/MPPS	Note
Requested Procedure ID	(0040,1001)	O	1	Yes/Yes	User can enter the value for Requested Procedure Id prior to query. If user has entered the value then that value will be sent as part of the query. The value returned in the response shall be mapped to the image.
Requested Procedure Description	(0032,1060)	O	1C	Yes/Yes	Truncated to 22 characters by default however this is configurable to allow 64 characters.
Requested Procedure Code Sequence	(0032,1064)	O	1C	Yes/No	
Code Value	(0008,0100)	O	1C	Yes/No	
Coding Scheme Designator	(0008,0102)	O	1C	Yes/No	
Code Meaning	(0008,0104)	O	3	Yes/No	NOTE: thought type 3, the scanner expects Code Meaning to be sent if (0032,1064) is sent.

Attribute Name	Tag	Expected Matching Key Type	Expected Returned Key Type	Mapped into the Image/MPPS	Note
Study Instance UID	(0020,000D)	0	1	Yes (Based on User option)/Yes	User (Modality) will be able to configure the following. If the user has set the option to "Use MWL Study UID", then study Instance UID will be copied into the final DICOM image header. If this option is not set then a new Study instance UID is generated locally on the scanner. The default setting is to generate a new study instance uid if a worklist entry is re-used however it can be configured to reuse the same study instance uid.
Referenced Study Sequence	(0008,1110)	0	2	Yes/Yes	Only 1 Referenced Study Sequence is mapped into the image.
Referenced SOP Class UID	(0008,1150)	0	1C	Yes/Yes	
Referenced SOP Instance UID	(0008,1155)	0	1C	Yes/Yes	
Requested Procedure Priority	(0040,1003)	0	2	No/No	
Patient Transport Arrangements	(0040,1004)	0	2	No/No	
Requested Procedure Location	(0040,1005)	0	3	No/No	
Confidentiality Code	(0040,1008)	0	3	No/No	

6.1.6.4 Imaging Service Request Entity

6.1.6.4.1 Imaging Service Request Module

Table 6.1.6.4.1-1 – Imaging Service Request Module Attributes

Attribute Name	Tag	Expected Matching Key Type	Expected Returned Key Type	Mapped into the Image/MPPS	Note
----------------	-----	----------------------------	----------------------------	----------------------------	------

Accession Number	(0008,0050)	O	2	Yes/Yes	User will be able to enter value for Accession Number prior to query to be sent as part of C-FIND request. Supports maximum of 16 characters.
Requesting Physician	(0032,1032)	O	2	No/No	
Referring Physician's Name	(0008,0090)	O	2	Yes/Yes	Truncated to 32 characters by default however this is configurable to allow 64 characters.
Requesting Service	(0032,1033)	O	3	No/No	

6.1.6.5 Visit Entity

6.1.6.5.1 Visit Identification

Table 6.1.6.5.1-1 – Visit Identification Module Attributes

Attribute Name	Tag	Expected Matching Key Type	Expected Returned Key Type	Mapped into the Image/MPPS	Note
Admission ID	(0038,0010)	O	2	No/No	
Institution Name	(0008,0080)	O	3	No/No	

6.1.6.5.2 Visit Status

Table 6.1.6.5.2-1 – Visit Status Module Attributes

Attribute Name	Tag	Expected Matching Key Type	Expected Returned Key Type	Mapped into the Image/MPPS	Note
Current Patient Location	(0038,0300)	O	2	No/No	Displayed on “More Info...” screen.

6.1.6.5.3 Visit Relationship

Table 6.1.6.5.3-1 – Relationship Module Attributes

Attribute Name	Tag	Expected Matching Key Type	Expected Returned Key Type	Mapped into the Image/ MPPS	Note
Referenced Patient Sequence	(0008,1120)	O	2	Yes/Yes	
Referenced SOP Class UID	(0008,1150)	O	2	Yes/Yes	
Referenced SOP Instance UID	(0008,1155)	O	2	Yes/Yes	

6.1.6.5.4 Visit Admission

No data elements are requested from the Visit Admission Module.

6.1.6.6 Patient Entity

6.1.6.6.1 Patient Relationship

No data elements are requested from the Patient Relationship Module.

6.1.6.6.2 Patient Identification

Table 6.1.6.6.2-1 – Patient Identification Module Attributes

Attribute Name	Tag	Expected Matching Key Type	Expected Returned Key Type	Mapped into the Image/ MPPS	Note
Patient's Name	(0010,0010)	R	1	Yes/Yes	Supports up to 32 characters by default however this is configurable to allow 64 characters. See also Note1 .
Patient ID	(0010,0020)	R	1	Yes/Yes	Supports up to 16 characters by default however this is configurable to 64 characters.
Other Patient ID	(0010, 1000)	O	3	Yes/No	Supports 64 characters.

Note 1 :

- Modality Worklist server supports 32 characters for patient Name
- Supports DICOM format for patient Name (with “^” as delimiters)
- If patient name in worklist has more than 32 characters then
 - Worklist will be accepted by the server
 - Worklist Browser will display only the first 32 characters
 - “More Info” screen will display the full patient name

- *Only the FIRST 32 characters is copied into the final DICOM image header by default however this is configurable to allow 64 characters.*

6.1.6.6.3 Patient Demographic

Table 6.1.6.6.3-1 – Patient Demographic Module Attributes

Attribute Name	Tag	Expected Matching Key Type	Expected Returned Key Type	Mapped into the Image/ MPPS	Note
Patient's Birth Date	(0010,0030)	0	2	Yes/Yes	This value is also used to calculate the Patient's Age.
Patient's Sex	(0010,0040)	0	2	Yes/Yes	
Patient's Weight	(0010,1030)	0	2	Yes/No	Limited to maximum value of 999 kg.
Confidentiality constraint on patient data	(0040,3001)	0	2	No/No	
Patient's Size	(0010,1020)	0	3	No/No	
Patient's Address	(0010,1040)	0	3	No/No	
Patient's Telephone Numbers	(0010,2154)	0	3	No/No	

6.1.6.6.4 Patient Medical

Table 6.1.6.6.4-1 – Patient Medical Module Attributes

Attribute Name	Tag	Expected Matching Key Type	Expected Returned Key Type	Mapped into the Image/ MPPS	Note
Patient State	(0038,0500)	0	2	No/No	
Pregnancy Status	(0010,21C0)	0	2	No/No	Displayed on "More Info..." screen.
Medical Alerts	(0010,2000)	0	2	No/No	Displayed on "More Info..." screen.
Contrast Allergies	(0010,2110)	0	2	No/No	Displayed on "More Info..." screen.
Special Needs	(0038,0050)	0	2	No/No	Displayed on "More Info..." screen.
Additional Patient History	(0010,21B0)	0	3	Yes/No	Displayed on "More Info..." screen.

6.2 Private Data Dictionary

The ModalityWorklist implementation does not define any Private Attributes within the Modality Worklist Information Model.

6.3 C-FIND Request Message

This section provides a detailed description of the C-FIND request message data that is provided to the remote AE during a worklist query operation. The dump in Table 6.4-1 below lists, in exact message order, the fields transferred as part of the C-FIND request message for a typical query.

In this particular dump, no values are specified for the Scheduled Procedure Step Start and End Dates (the attributes are sent with zero length). In DICOM this is interpreted as meaning all dates (i.e. universal matching). The Modality is also not specified in this particular dump, meaning all modalities. Note that the user, through the use of the GEHC CT user interface, can submit a worklist query that will cause non-zero values to be sent for these attributes.

Table 6.3-1 – C-FIND Request Message Dump

```
(0008,0000) UL 108          # 4, 1 IdentifyingGroupLength
(0008,0005) CS [ISO_IR 100] # 12, 1 SpecificCharacterSet
(0008,0050) SH (no value available) # 0, 0 AccessionNumber
(0008,0080) LO (no value available) # 0, 0 InstitutionName
(0008,0090) PN (no value available) # 0, 0 ReferringPhysicianName
(0008,1110) SQ (Sequence with explicit Length #=1) # 24, 1 ReferencedStudySequence
(fffe,e000) na (Item with explicit Length #=2) # 16, 1 Item
  (0008,1150) UI (no value available) # 0, 0 ReferencedSOPClassUID
  (0008,1155) UI (no value available) # 0, 0 ReferencedSOPInstanceUID
(fffe,e00d) na (ItemDelimitationItem for re-encoding) # 0, 1 ItemDelimitationItem
(fffe,e0dd) na (SequenceDelimitationItem for re-enc.) # 0, 1 SequenceDelimitationItem
(0008,1120) SQ (Sequence with explicit Length #=1) # 24, 1 ReferencedPatientSequence
(fffe,e000) na (Item with explicit Length #=2) # 16, 1 Item
  (0008,1150) UI (no value available) # 0, 0 ReferencedSOPClassUID
  (0008,1155) UI (no value available) # 0, 0 ReferencedSOPInstanceUID
(fffe,e00d) na (ItemDelimitationItem for re-encoding) # 0, 1 ItemDelimitationItem
(fffe,e0dd) na (SequenceDelimitationItem for re-enc.) # 0, 1 SequenceDelimitationItem
(0010,0000) UL 96          # 4, 1 PatientGroupLength
(0010,0010) PN (no value available) # 0, 0 PatientName
(0010,0020) LO (no value available) # 0, 0 PatientID
(0010,0030) DA (no value available) # 0, 0 PatientBirthDate
(0010,0040) CS (no value available) # 0, 0 PatientSex
(0010,1000) LO (no value available) # 0, 0 Other Patient IDs
(0010,1020) DS (no value available) # 0, 0 PatientSize
(0010,1030) DS (no value available) # 0, 0 PatientWeight
(0010,1040) LO (no value available) # 0, 0 PatientAddress
(0010,2000) LO (no value available) # 0, 0 MedicalAlerts
(0010,2110) LO (no value available) # 0, 0 ContrastAllergies
(0010,2154) SH (no value available) # 0, 0 PatientTelephoneNumber
(0010,2160) SH (no value available) # 0, 0 Ethinc Group
(0010,21b0) LT (no value available) # 0, 1 AdditionalPatientHistory
(0010,21c0) US (no value available) # 0, 0 PregnancyStatus
(0010,4000) LT (no value available) # 0, 0 Patient Comments
(0020,0000) UL 8          # 4, 1 ImageGroupLength
(0020,000d) UI (no value available) # 0, 0 StudyInstanceUID
(0032,0000) UL 64          # 4, 1 StudyGroupLength
(0032,1032) PN (no value available) # 0, 0 RequestingPhysician
(0032,1033) LO (no value available) # 0, 0 RequestingService
```

```

(0032,1060) LO (no value available) # 0, 0 RequestedProcedureDescription
(0032,1064) SQ (Sequence with explicit Length #=1) # 32, 1 RequestedProcedureCodeSequence
(fffe,e000) na (Item with explicit Length #=3) # 24, 1 Item
(0008,0100) SH (no value available) # 0, 0 CodeValue
(0008,0102) SH (no value available) # 0, 0 CodingSchemeDesignator
(0008,0104) LO (no value available) # 0, 0 CodeMeaning
(fffe,e00d) na (ItemDelimitationItem for re-encoding) # 0, 1 ItemDelimitationItem
(fffe,e0dd) na (SequenceDelimitationItem for re-enc.) # 0, 1 SequenceDelimitationItem
(0038,0000) UL 32 # 4, 1 VisitGroupLength
(0038,0010) LO (no value available) # 0, 0 AdmissionID
(0038,0050) LO (no value available) # 0, 0 SpecialNeeds
(0038,0300) LO (no value available) # 0, 0 CurrentPatientLocation
(0038,0500) LO (no value available) # 0, 0 PatientState
(0040,0000) UL 192 # 4, 1 ModalityWorklistGroupLength
(0040,0100) SQ (Sequence with explicit Length #=1) # 136, 1 ScheduledProcedureStepSequence
(fffe,e000) na (Item with explicit Length #=12) # 128, 1 Item
(0008,0060) CS (no value available) # 0, 0 Modality
(0032,1070) LO (no value available) # 0, 0 RequestedContrastAgent
(0040,0001) AE (no value available) # 0, 0 ScheduledStationAETitle
(0040,0002) DA (no value available) # 0, 0 ScheduledProcedureStepStartDate
(0040,0003) TM (no value available) # 0, 0 ScheduledProcedureStepStartTime
(0040,0006) PN (no value available) # 0, 0 ScheduledPerformingPhysiciansName
(0040,0007) LO (no value available) # 0, 0 ScheduledProcedureStepDescription
(0040,0008) SQ (Seq with explicit Length #=1) # 32, 1 ScheduledActionItemCodeSequence
(fffe,e000) na (Item with explicit Length #=3) # 24, 1 Item
(0008,0100) SH (no value available) # 0, 0 CodeValue
(0008,0102) SH (no value available) # 0, 0 CodingSchemeDesignator
(0008,0104) LO (no value available) # 0, 0 CodeMeaning
(fffe,e00d) na (ItemDelimitationItem for re-encoding) # 0, 1 ItemDelimitationItem
(fffe,e0dd) na (SequenceDelimitationItem for re-enc.) # 0, 1 SequenceDelimitationItem
(0040,0009) SH (no value available) # 0, 0 ScheduledProcedureStepID
(0040,0010) SH (no value available) # 0, 0 ScheduledStationName
(0040,0011) SH (no value available) # 0, 0 ScheduledProcedureStepLocation
(0040,0012) LO (no value available) # 0, 0 PreMedication
(fffe,e00d) na (ItemDelimitationItem for re-encoding) # 0, 1 ItemDelimitationItem
(fffe,e0dd) na (SequenceDelimitationItem for re-enc.) # 0, 1 SequenceDelimitationItem
(0040,1001) SH (no value available) # 0, 0 RequestedProcedureID
(0040,1003) SH (no value available) # 0, 0 RequestedProcedurePriority
(0040,1004) LO (no value available) # 0, 0 PatientTransportArrangements
(0040,1005) LO (no value available) # 0, 0 RequestedProcedureLocation
(0040,1008) LO (no value available) # 0, 0 ConfidentialityCode
(0040,1010) PN (no value available) # 0, 0 Names of Intended Recipients
(0040,1400) LT (no value available) # 0, 0 Requested Procedure Comments
(0040,2400) LT (no value available) # 0, 0 Imaging Service Request Comm.
(0040,3001) LO (no value available) # 0, 0 ConfidentialityConstraintOnPatientData
  
```

If the query is for a particular date range, the ScheduledProcedureStepStartDate will be filled with a valid date range. If either the start or end date are left blank by the user, they will simply be blank in the query.

Below is an example of a date range for August 30, 1997 through October 12, 1997.

```
(0040,0002) DA [19970830-19971012] # 18, 1 ScheduledProcedureStepStartDate
```

Below is an example of a date range for August 30, 1997 through the end of time.

```
(0040,0002) DA [19970830-] # 18, 1 ScheduledProcedureStepStartDate
```

Below is an example of a date range from the beginning of time through August 30, 1997.

```
(0040,0002) DA [-19970830] # 18, 1 ScheduledProcedureStepStartDate
```

If the query is for records for this modality, the Modality will be filled in as follows:

(0008,0060) CS [CT] # 2, 1 Modality

If the query is for records for this Scanner, the Modality will be filled in with CT as above and the Scheduled Station AE Title will be filled in with the value configured for this system. For example, this station was configured as CTRoom1.

(0040,0001) AE [CTRoom1] # 8, 1 ScheduledStationAETitle

User will be able to enter the values for "Accession Number" prior to the query. If value is entered then that value will be sent as part of the query. For example, if "1234" is entered then

(0008,0050) SH [1234] # 4, 1 AccessionNumber

User will be able to enter the values for "Requested Procedure Id" prior to the query. If value is entered then that value will be sent as part of the query. For example, if "3456" is entered then

(0040,1001) SH [3456] # 4, 1 RequestedProcedureID

User will be able to enter the values for "Patient Id" prior to the query. If value is entered then that value will be sent as part of the query. For example, if "6789" is entered then

(0010,0020) LO [6789] # 4, 1 PatientID

User will be able to enter the values for "Patient Name" prior to the query. If value is entered then that value will be sent as part of the query. For example, if "Lastname^Firstname" is entered then

(0010,0010) PN [Lastname^Firstname] # 18, 1 PatientName

6.4 Use of Specific DICOM Data

This section details the use of the DICOM data returned by remote AEs during worklist queries. The GEHC CT user interface fields that display the data, along with the data's mapping into resulting acquired and transferred DICOM images, are presented in following table 6.5-1.

Table 6.4-1 – Specific Data Usage

DICOM Worklist Data Element	Patient Schedule Screen Field	GEHC CT DICOM Image Data Element
-----------------------------	-------------------------------	----------------------------------

Accession Number (0008,0050)	Req Number	Accession Number Supports maximum of 16 characters. Can be configured so the top level accession number tag in the image header will be empty if worklists are grouped and have different accession numbers. Default behavior is to fill in the top level accession number in the grouped case.
Patient ID (0010,0020)	Patient ID	Patient ID Supports maximum of 16 characters. Can be configured to allow 64 characters.
Other Patient ID (0010,1000)	Other Patient Ids (only displayed on the More Info screen)	Patient ID Supports maximum of 64 characters.
Patient Name (0010,0010)	Patient Name	Patient Name Supports maximum of 32 characters. Can be configured to allow 64 characters.
Patient's Birth Date (0010,0030)	Patient Age (Patient Birth Date user to calculate age)	Patient Birth Date
Patient's Sex (0010,0040)	Sex	Patient's Sex
Patient's Weight (0010,1030)	Weight in Kg	Patient's Weight
Referring Physician's Name (0008,0090)	Referring Physician	Referring Physician's Name
Requested Procedure Description (0032,1060)	Exam Description	Study Description.
Scheduled Procedure Step Start Date (0040,0002)	Date	Not available.
Scheduled Procedure Step Start Time (0040,0003)	Time	Not available.
Scheduled Performing Physician's Name (0040,0006)	Performing Physician (only displayed on the "More Info.." screen)	This value is mapped into (0008, 1050) in the image header.
Study Instance UID (0020,000d)	Study instance UID (only displayed on the "More Info..." screen)	Study Instance UID, if User has set the preference to "Use MWL Study UID" .
Requested Procedure Id (0040,1001)	Requested Proc ID	Requested Procedure Id.
Pregnancy Status (0010,21C0)	Pregnancy Status (only displayed on the "More Info..." screen)	Not available.

Medical Alerts (0010,2000)	Medical Alerts (only displayed on the "More Info..." screen)	Not available.
Contrast Allergies (0010,2110)	Contrast Allergies (only displayed on the "More Info..." screen)	Not available.
Special Needs (0038,0050)	Special Needs (only displayed on the "More Info..." screen)	Not available.
Requested Contrast Agent (0032,1070)	Requested Contrast Agent (only displayed on the "More Info..." screen)	Not available.
Current Patient Location (0038,0300)	Current Patient Location (only displayed on the "More Info..." screen)	Not available.
Additional Patient History (0010,21B0)	Additional Patient History (only displayed on the "More Info..." screen)	Patient History.

Note that the display of a specific data item on the "More Info..." screen is contingent on the item being enabled for display. Depending on the preferences of each specific site, data can either be displayed or not. A GE field service engineer can assist in setting these site preferences.

6.5 Setting User Preferences

6.5.1 Setting "Use MWL Study UID " Option

Setting this option to "**Yes**" copies the **Study Instance UID** from Worklist into the final **DICOM Image header**. If this option is set to "**No**" then a new study instance uid will be generated locally.

1. Click on "Patient Schedule"
2. Click on "Preferences" button
3. Set the option "Use Study UID?", to either "Yes" or "No"

6.5.2 Setting Custom Query Option

This option allows the user to enter values for "Accession Number" and / or "Requested Procedure Id", which are used for Custom Query.

1. Click on "Patient Schedule"
2. Click on "Preferences" button
3. Set the option "**Show Update Parameters?** ", to "**Yes**"

- 4.To do a query click on "Update" button.
A User Interface appears, with provision to enter values for:
- a) Accession Number
 - b) Requested Proc. ID

7 Modality Performed Procedure Step Implementation

7.1 Introduction

This section of the DICOM Conformance Statement specifies the compliance to DICOM conformance requirements for the Modality Performed Procedure Step feature on this GEHC product. Note that the format of this section strictly follows the format defined in DICOM Standard PS 3.2 (Conformance). Please refer to that part of the standard while reading this section. The PPS option for GEHC CT allows a Modality Performed Procedure Step to be communicated to the Hospital/Radiology information system. The PPS feature is providing the DICOM Modality Performed Procedure Step service as a service class user (SCU).

This feature works in conjunction with DICOM Modality Worklist feature, if installed. However the conformance of this feature is independent of Modality Worklist feature. For information on conformance of Modality Worklist feature to DICOM standard please refer to the appropriate section or document.

7.2 N-CREATE & N-SET Request Message

PPS Feature for GEHC CT supports all named attributes listed in Table F.7.2.1 in PS3.4 of DICOM standard. That is, attributes that are not explicitly referenced by name in the table are not supported. (Example is last row in the table reads "All other attributes from Radiation Dose Module and Billing and Material Code Module". The attributes referenced here are not supported).

For the MPPS associated with an acquisition, the following attributes are copied from the Modality Worklist SCU into the MPPS request Message, if procedure performed corresponds to the SPS information retrieved through the Modality Worklist.

GEHC CT supports the selection of single or multiple SPS for a scan. The following are applicable.

- Single SPS selection results in single PPS message
- Multiple SPS selection results in single PPS message
- Multiple SPS selection is allowed **only if they all correspond to same patient id**
- A maximum of 15 SPS's can be selected
- Referenced Study Sequence - a maximum of ten Item's is supported. *This attribute will be present only if SPS information is available from Modality Worklist SCU.*

- At the end of acquisition the user might choose to 'Defer PPS' and later choose to 'Complete PPS' or 'Discontinue PPS' from the user interface provided in the system. In this case, the date and time when user chooses to 'Complete PPS' or 'Discontinue PPS' is taken as the Performed Procedure Step End Date and Performed Procedure Step End Time respectively (Not the actual end date and end time of acquisition)
- Mapping of SPS data to **MPPS SOP instance** is explained in section 7.3
- Mapping of specific SPS data to **CT DICOM IMAGE HEADER** , for PPS is explained in section 7.4

For the MPPS associated with a post-processing the following restrictions apply on the attributes listed below.

- Referenced Study Sequence – The sequence is not sent in the MPPS message
- Scheduled Step Attribute Sequence – a maximum of ONE item is supported. The attribute will be send only if SPS information is available in the image instance.
- Referenced Patient Sequence – This sequence is not added
- Scheduled Protocol Code Sequence – The sequence is not send in the MPPS message
- Performed Procedure Step Start date & Performed Procedure Step start time – The exam date and exam time that is the Start date and Start Time of the associated Study Component (Exam) is used, not the actual time when post-processing started.
- Performed Procedure Step end date & Performed Procedure Step end time - The date and time when user chooses to 'Complete PPS' or 'Discontinue PPS' is taken as the Performed Procedure Step End Date and Performed Procedure Step End Time respectively (Not the actual end date and end time of post-processing).
- Procedure Code Sequence – This sequence is sent with ZERO items in the MPPS message
- Performed Protocol Code Sequence – This sequence is sent with ZERO items in the MPPS message.
- Referenced Standalone SOP Instance Sequence – The sequence is sent with ZERO items in the MPPS message.

7.3 MODALITY PERFORMED PROCEDURE STEP MODULE DEFINITIONS

The following table gives specific usage of some of attributes in the MPPS SOP instance created, with reference to each of the real-world scenarios mentioned in 2.3.1.2.7.1.1 of this document.

Attribute Name	Tag	Usage in MPPS Instance		
		Acquisition with MWL data	Acquisition without MWL data	Post-Processing
Specific Character Set	(0008,0005)	Not used, but copied into image header	Not used	Not used, but copied into image header
Scheduled Step Attribute Sequence	(0040,0270)	Up to 15 items		Up to 15 items
>Study Instance UID	(0020,000D)	Copied from SPS, if option to copy is selected or else created at the scanner	Created at the scanner	Copied from source image
>Referenced Study Sequence	(0008,1110)	Copied from SPS, if selected	Not sent as part of image header	Not sent as part of image header
>Accession Number	(0008,0050)	Copied from SPS, if selected	User input on the scanner	Copied from source image
>Placer Order Number/Imaging Service Request	(0040,2016)	Not sent as part of image header	Not sent as part of image header	Not sent as part of image header
>Filler Order Number/Imaging Service Request	(0040,2017)	Not sent as part of image header	Not sent as part of image header	Not sent as part of image header
>Requested Procedure ID	(0040,1001)	Copied from SPS, if selected	User input on the scanner	Copied from source image
>Requested Procedure Description	(0032,1060)	Copied from SPS, if selected	Not used	Not sent as part of image header
>Placer Order Number/Procedure	(0040,1006)	Not sent as part of image header	Not used	Not sent as part of image header
>Filler Order Number/Procedure	(0040,1007)	Not sent as part of image header	Not used	Not sent as part of image header
>Scheduled Procedure ID	(0040,0009)	Copied from SPS, if selected	Not used	Copied from source image
> Scheduled Performing Physician's Name	(0040,0006)	Copied from SPS, if selected	Not used	Copied from source image
>Scheduled Procedure Step Description	(0040,0007)	Copied from SPS, if selected	Not used	Copied from source image
>Scheduled Protocol Code Sequence	(0040,0008)	Copied from SPS, if selected	Not used	Not sent as part of image header
Patient's Name	(0010,0010)	Copied from SPS, if selected	User input on the scanner	Copied from source image

Attribute Name	Tag	Usage in MPPS Instance		
		Acquisition with MWL data	Acquisition without MWL data	Post-Processing
Patient ID	(0010,0020)	Copied from SPS, if selected	User input on the scanner	Copied from source image
Patient's Birth Date	(0010,0030)	Copied from SPS, if selected	User input on the scanner	Copied from source image
Patient's Sex	(0010,0040)	Copied from SPS, if selected	User input on the scanner	Copied from source image
Referenced Patient Sequence	(0008,1120)	Copied from SPS, if selected	Sent empty, zero length	Sent empty, zero length
Performed Procedure Step ID	(0040,0253)	Created at the scanner. Will have the following "PPS_ID_<exam number"	Created at the scanner. Will have the following "PPS_ID_<exam number"	New generated, may not be unique
Performed Station AE Title	(0040,0241)	Local system host-name	Local system host-name	Local system host-name
Performed Station Name	(0040,0242)	Local system suite id	Local system suite id	Local system host-name
Performed Location	(0040,0243)	Local system suite id	Sent empty, zero length	Sent empty, zero length
Performed Procedure Step Start Date	(0040,0244)	Same as exam start date	Same as exam date	Same as exam date
Performed Procedure Step Start Time	(0040,0245)	Same as exam start time	Same as exam time	Same as exam time
Performed Procedure Step Description	(0040,0254)	Copied from SPS, if selected	Not sent as part of image header	Not sent as part of image header
Performed Procedure Step status	(0040,0252)	See Note 1.	See Note 1.	See Note 1.
Performed Procedure Type Description	(0040,0255)	Not sent as part of image header	Not sent as part of image header	Not sent as part of image header
Procedure Code Sequence	(0008,1032)	Not sent as part of image header. Not sent in MPPS N-Create.	Not sent as part of image header. Not sent in MPPS N-Create.	Not sent as part of image header. Not sent in MPPS N-Create.
Performed Procedure Step End Date	(0040,0250)	Date when all images got installed	Date when all images got installed	The date "Complete PPS" or "Discontinue PPS" is invoked, not the actual end of post-processing
Performed Procedure Step End Time	(0040,0251)	Time when all images got installed	Time when all images got installed	The time "Complete PPS" or "Discontinue PPS" is invoked, not the actual end of post-processing

Attribute Name	Tag	Usage in MPPS Instance		
		Acquisition with MWL data	Acquisition without MWL data	Post-Processing
Performed Procedure Step Discontinuation Reason Code Sequence	(0040,0281)	The reason of the Performed Procedure Step Status(0040,0252) was set to "DISCONTINUED".		
>Code Value	(0008,0100)	Sent as "110513"		
>Coding Scheme Designator	(0008,0102)	Sent as "DCM"		
>Code Meaning	(0008,0104)	Sent as "Discontinued for unspecified reason"		
Modality	(0008,0060)	Value "CT" is stored in image header	Value "CT" is stored in image header	Value "CT" is stored in image header
Study ID	(0020,0010)	Same as exam number	Same as exam number	Copied from source image
Performed Protocol Code Sequence	(0040,0260)	Derived from (0040, 0008)	Not used	Not used
Performed Series Sequence	(0040,0340)	One item for each series created	One item for each series created	One item for each series created with post-processing
>Performing Physician's Name	(0008,1050)	Copied from SPS, if selected	User input on the scanner	Copied from source image
>Protocol Name	(0018,1030)	The name of the protocol selected on the scanner	The name of the protocol selected on the scanner	Copied from source image
>Operator's Name	(0008,1070)	Copied from SPS if selected and present otherwise from user input on the scanner	User input on the scanner	Not sent as part of image header
>Retrieve AE Title	(0008,0054)	Local system host-name	Local system host-name	host-name of the system
>Referenced Image Sequence	(0008,1140)	One item for each image created within the series	One item for each image created within the series	One item for each image generated by post-processing
>Referenced Standalone SOP Instance Sequence	(0040,0220)	One item for each GSPS or Dose SR created within the series	One item for each GSPS or Dose SR created within the series	One item for each GSPS or Dose SR created within the series
>All other attributes from Performed Series Sequence (which Table F.7.2.1 of DICOM standard PS3.4 does not explicitly		Not sent as part of image header	Not sent as part of image header	Not sent as part of image header

Attribute Name	Tag	Usage in MPPS Instance		
		Acquisition with MWL data	Acquisition without MWL data	Post-Processing
list)				
All other attributes from Radiation Dose Module and Billing and Material Code Module (which Table F.7.2.1 of DICOM standard PS3.4 does not explicitly list)		Not sent as part of image header	Not sent as part of image header	Not sent as part of image header

- Note 1:**
- When PPS start (N-CREATE) message is sent, this element will have the value "IN PROGRESS"
 - When PPS end (N-SET) message is sent, this element will have either "COMPLETED" or "DISCONTINUED" based on user selection

7.4 Use of Specific DICOM Data

7.4.1 Patient Level

Attribute Name	Tag	Usage in CT DICOM Image Header
Patient Name	(0010,0010)	Copied from SPS, if selected
Patient ID	(0010,0020)	Copied from SPS, if selected
Patient Birthdate	(0010,0030)	Copied from SPS, if selected
Patient Sex	(0010,0040)	Copied from SPS, if selected
Referenced Patient Sequence	(0008,1120)	Copied from SPS, if selected
Ref. SOP class uid	(0008,1150)	
Ref. SOP Instance uid	(0008,1155)	

7.4.2 Study Level

Attribute Name	Tag	Usage in CT DICOM Image Header
Study Instance UID	(0020,000D)	Copied from SPS, if selected
Study ID	(0020,0010)	Scanner generated study ID
Referring Physicians name	(0008,0090)	Copied from SPS, if selected
Accession Number	(0008,0050)	If multiple SPS's are selected, then accession number from the first selection (determined by the user) is used, however, it is configurable to be set to zero length. Default is to use the accession number from the first selection.
Referenced Study Sequence	(0008,1110)	Copied from SPS, if selected

Attribute Name	Tag	Usage in CT DICOM Image Header
Ref. SOP class uid	(0008,1150)	
Ref. SOP Instance uid	(0008,1155)	

7.4.3 Series Level

Attribute Name	Tag	Usage in CT DICOM Image Header
Modality	(0008,0060)	Value "CT" is copied
Protocol Name	(0018,1030)	Name of the selected protocol is copied
Operator Name	(0008,1070)	Copied from SPS if selected and present otherwise generated from user input on scanner
Referenced Performed Procedure Step Sequence	(0008,1111)	
Ref. SOP class uid	(0008,1150)	Value of MPPS SOP class UID
Ref. SOP Instance uid	(0008,1155)	Scanner generated unique UID
Requested Attribute Sequence	(0040,0275)	Will be present only if SPS obtained from HIS/RIS is selected for scanning. If multiple SPS's are selected then this will contain multiple items one for each SPS. For all other cases this element will not be present
Requested Procedure Id	(0040,1001)	Copied from SPS, if selected
Scheduled Procedure Step Id	(0040,0009)	Copied from SPS, if selected
Scheduled Procedure Step description	(0040,0007)	Copied from SPS, if selected
Scheduled Protocol Code Sequence	(0040,0008)	Copied from SPS, if selected
Performed Procedure Step Id	(0040,0253)	Created at the scanner. The string " PPS_ID_<exam number> " is used.
Performed Procedure Step start date	(0040,0244)	Same as exam start date
Performed Procedure Step start time	(0040,0245)	Same as exam start time
Performed Procedure Step description	(0040,0254)	Exam description is used

8 Grayscale Softcopy Presentation State Implementation

8.1 Introduction

This section specifies the use of the DICOM Grayscale Softcopy Presentation State (GSPS) IOD to represent the information included in GSPSs produced by this product.

8.2 CT Mapping of DICOM Entities

The CT system maps DICOM Information Entities to local Information Entities in the product's database and user interface.

DICOM IE	CT Entity
Patient	Patient
Study	Exam
Series	Series
Presentation State	Presentation State

8.3 IOD Module Table

The Grayscale Softcopy Presentation State Information Object Definition comprises the modules of the following table.

Entity Name	Module Name	Reference	Usage
Patient	Patient	8.4.1.1	M
Study	General Study	8.4.2.1	M
	Patient Study	8.4.2.2	U
Series	General Series	8.4.3.1	M
	Presentation Series	8.4.3.2	M
Equipment	General Equipment	8.4.4.1	M
Presentation State	Presentation State Identification	8.4.5.1	M
	Presentation State Relationship	8.4.5.2	M
	Presentation State Shutter	Exam Split : Not sent (attribute condition not met) Save State : 8.4.5.3	M
	Presentation State Mask	Not sent (attribute condition not met)	M
	Mask	Not sent (no multi-frame present)	C
	Display Shutter	Not sent (no display shutter)	C
	Bitmap Display Shutter	Not sent (no bitmap data present)	C

	Overlay Plane	Not sent (no overlay data present)	C
	Overlay Activation	Not sent (no overlay data present)	C
	Displayed Area	8.4.5.4	M
	Graphic Annotation	Not sent (no annotation data present)	C
	Spatial Transformation	Not sent (no flip/rotate being applied)	C
	Graphic Layer	Not sent (no graphics layers are added)	C
	Modality LUT	8.4.5.5	C
	Softcopy VOI LUT	8.4.5.6	C
	Softcopy Presentation LUT	8.4.5.7	M
	SOP Common	8.4.5.8	M

8.4 Information Module Definitions

Please refer to DICOM Part 3 (Information Object Definitions) for a description of each of the entities, modules, and attributes contained within the GSPS Information Object. The following modules are included to convey Enumerated Values, Defined Terms, and Optional Attributes supported. Type 1 & Type 2 Attributes are also included for completeness and to define what values they may take and where these values are obtained from when generating the instance. It should be noted that they are the same ones as defined in the DICOM Standard Part 3 (Information Object Definitions). Also note that Attributes not present in tables are not supported

8.4.1 Patient Entity Module

8.4.1.1 Patient Module

Attribute Name	Tag	Type	Notes
Patient's Name	(0010,0010)	2	Copied from original images
Patient ID	(0010,0020)	2	Copied from original images
Patient's Birth Date	(0010,0030)	2	Copied from original images
Patient's Sex	(0010,0040)	2	Copied from original images
Other Patient ID	(0010,1000)	3	Copied from original images

8.4.2 Study Entity Module

8.4.2.1 General Study Module

Attribute Name	Tag	Type	Notes
Study Instance UID	(0020,000D)	1	Copied from original images

Attribute Name	Tag	Type	Notes
Study Date	(0008,0020)	2	Copied from original images
Study Time	(0008,0030)	2	Copied from original images
Accession Number	(0008,0050)	2	Copied from original images
Referring Physician's Name	(0008,0090)	2	Copied from original images
Referenced Study Sequence	(0008,1110)	3	Exam Split : Copied from original images Save State : Not sent
> Referenced SOP Class UID	(0008,1150)	1	Value copied from original Images corresponding to the Requested Procedure this GSPS is responding to.
> Referenced SOP Instance UID	(0008,1155)	1	Value copied from original Images corresponding to the Requested Procedure this GSPS is responding to
Study ID	(0020,0010)	2	Copied from original images
Study Description	(0008,1030)	3	Exam Split : Copied from original images Save State : Not Sent

Note: If two or more of the accession numbers in the grouped case are different, the top level Accession Number (0008, 0050) shall contain 1 of the accession numbers if the relevant CT Image Objects contain a value in the top level Accession Number (0008, 0050) otherwise the top level Accession Number shall be zero length.

8.4.2.2 Patient Study Module

Attribute Name	Tag	Type	Notes
Patient's Age	(0010,1010)	3	Copied from original images
Patient's Size	(0010,1020)	3	Copied from original images
Patient's Weight	(0010,1030)	3	Copied from original images
Additional Patient's History	(0010,21b0)	3	Not Sent.

8.4.3 Series Entity Module

8.4.3.1 General Series Module

Attribute Name	Tag	Type	Notes
Series Number	(0020,0011)	2	Set to(original Series Number + 100000)
Laterality	(0020,0060)	2C	Always sent zero-length.
Series Date	(0008,0021)	3	Not Sent.
Series Time	(0008,0031)	3	Not Sent.

Modality	(0008,0060)	1	"PR"
Performing Physician's Name	(0008,1050)	3	Not Sent.
Protocol Name	(0018,1030)	3	Not Sent.
Series Description	(0008,103E)	3	Exam Split : This will be set as Requested Procedure Code Meaning. If Code Meaning absent, it will be Requested Procedure Description Save State : "Presentation Series"
Operators Name	(0008,1070)	3	Not sent
Series Instance UID	(0020,000E)	1	Generated new number for each series and always sent.
Performed Procedure Step Start Date	(0040,0244)	3	Exam Split : Calculated and sent. Save State ; Not sent
Performed Procedure Step Start Time	(0040,0245)	3	Exam Split : Calculated and sent. Save State : Not sent.
Performed Procedure Step ID	(0040,0253)	3	Exam Split : Will be set as Requested Procedure ID (0040,1001) from (0040,0275) Save State : Not sent.
Performed Procedure Step Description	(0040,0254)	3	Exam Split : This will be set as Requested Procedure Code Meaning with a "PGP-" prefix. If Code Meaning absent, it will be Requested Procedure Description. The length will be truncated to 64 if necessary. Save State : Not sent.
Requested Attributes Sequence	(0040,0275)	3	Exam Split : Sent when MPPS option is enabled and filled in based on what RIS provides to scanner. Number of items relates to number of items selected from Patient Schedule. Save State : Not sent.
> Requested Procedure ID	(0040,1001)	1C	Exam Split : Always sent, copied from RIS Save State : Not sent.
> Accession Number	(0008,0050)	3	Exam Split : Value from worklist sent Save State : Not sent.
> Referenced Study Sequence	(0008,1110)	3	Exam Split : Value from worklist sent Save State : Not sent.
> Study Instance UID	(0020,000D)	3	Exam Split : Value from worklist sent Save State : Not sent.
> Requested Procedure Desc	(0032,1060)	3	Exam Split : Value from worklist sent Save State : Not sent.

> Requested Procedure Code Sequence	(0032,1064)	3	Exam Split : Value from worklist sent. Save State : Not sent.
> Scheduled Procedure Step Desc	(0040,0007)	3	Exam Split : Value from worklist sent Save State : Not sent.
> Scheduled Protocol Code Sequence	(0040,0008)	3	Exam Split : Value from worklist sent Save State : Not sent.
> Scheduled Procedure Step ID	(0040,0009)	3	Exam Split : Value from worklist sent Save State : Not sent.
> Reason for Requested Procedure	(0040,1002)	3	Exam Split : Value from worklist sent Save State : Not sent.
> Reason for Requested Procedure Code sequence	(0040,1004)	3	Exam Split : Value from worklist sent Save State : Not sent.
Referenced Performed Procedure Step Sequence	(0008,1111)	3	Exam Split : Value used for performed procedure step Save State : Not Sent.
>Referenced SOP Class UID	(0008,1150)	1C	Copied from original images
>Referenced SOP Instance UID	(0008,1155)	1C	Generated for each series and always sent.

Note: If scheduled procedures are grouped, the accession number for each procedure is stored in the Request Attributes Sequence (0040, 0275) in the image header.

8.4.3.2 Presentation Series Module

Attribute Name	Tag	Type	Notes
Modality	(0008,0060)	1	"PR"

8.4.4 Equipment Module

8.4.4.1 General Equipment

Attribute Name	Tag	Type	Notes
Manufacturer	(0008,0070)	2	Always sent as "GE MEDICAL SYSTEMS"
Institution Name	(0008,0080)	3	Copied from original images
Station Name	(0008,1010)	3	Copied from original images
Manufacturers Model Name	(0008,1090)	3	Copied from original images
Software Versions	(0018,1020)	3	Copied from original images

8.4.5 Presentation State Entity Module

8.4.5.1 Presentation State Identification Module

Attribute Name	Tag	Type	Notes
Presentation Creation Date	(0070,0082)	1	Calculated and sent.
Presentation Creation Time	(0070,0083)	1	Calculated and sent.
Instance Number	(0020,0013)	1	Set to 23 and sent.
Content Label	(0070,0080)	1	Exam Split: This will be set as "PGP" plus Requested Procedure Code Meaning or Requested Procedure Description converted to all capital letters and truncated to 16 characters. Save State : "GEGSPS_0"
Content Description	(0070,0081)	2	Exam Split : String input on Comments box in Exam Split screen Save State : "SE (Series Number) IM (First Image Number) TO IM (Last Image Number)"
Content Creator's Name	(0070,0084)	2	Same as Station Name(0008,1010)

8.4.5.2 Presentation State Relationship

Attribute Name	Tag	Type	Notes
Referenced Series Sequence	(0008,1115)	1	Calculated and sent.
> Referenced Image Sequence	(0008,1140)	1	Always sent, references images selected.
>> Reference SOP Class UID	(0008,1150)	1	Always sent
>> Reference SOP Instance UID	(0008,1155)	1	Always sent
> Series Instance UID	(0020,000E)	1	Always sent, references series selected

8.4.5.3 Presentation State Shutter

Attribute Name	Tag	Type	Notes
Shutter Presentation Value	(0018,1622)	1	Exam Split : Not sent. Save State : Always sent.

8.4.5.4 **Displayed Area**

Attribute Name	Tag	Type	Notes
Displayed Area Selection Sequence	(0070,005A)	1	Exam Split : calculated values for pan and zoom being displayed. Save State : the number of images in the original series
>Referenced Image Sequence	(0008,1140)	1C	Always sent.
>Displayed Area Top Left Hand Corner	(0070,0052)	1	Always sent.
>Displayed Area Bottom Right Hand Corner	(0070,0053)	1	Always sent.
>Presentation Size Mode	(0070,0100)	1	Always sent.
>Presentation Pixel Spacing	(0070,0101)	1C	Always sent.
>Presentation Pixel Magnification Ratio	(0070,0103)	1C	Always sent.

8.4.5.5 **Modality LUT Module**

Attribute Name	Tag	Type	Notes
Rescale slope intercept	(0028,1052)	1C	Always sent
Rescale slope	(0028,1053)	1C	Always sent
Rescale type	(0028,1054)	1C	Always sent as "HU"

8.4.5.6 **Softcopy VOI LUT Module**

Attribute Name	Tag	Type	Notes
Softcopy VOI LUT Sequence	(0028,3110)	1	Always sent
> Reference Image Sequence	(0008,1140)	1C	Always sent
> Window Center	(0028,1050)	1C	Always sent
> Window Width	(0028,1051)	1C	Always sent
> Window Center & Width Explanation	(0028,1055)	3	Always sent

8.4.5.7 **Softcopy Presentation LUT Module**

Attribute Name	Tag	Type	Notes
----------------	-----	------	-------

Presentation LUT sequence	(2050,0010)	1C	Not sent, condition not met.
Presentation LUT shape	(2050,0020)	1C	Always sent as "IDENTITY"

8.4.5.8 SOP Common Module

Attribute Name	Tag	Type	Notes
SOP Class UID	(0008,0016)	1	Always sent.
SOP Instance UID	(0008,0018)	1	Always sent.
Specific Character Set	(0008,0005)	1C	"ISO_IR 100"
Instance Creation Date	(0008,0012)	3	Always sent.
Instance Creation Time	(0008,0013)	3	Always sent.
Instance Number	(0020,0013)	1	Set to 23 and sent.

8.5 Image Header Changes Supporting GSPS

8.5.1 Request Attributes Sequence

The (0040, 0275) Request Attributes Sequence has been expanded to include DICOM tags that the Virtual Exam Split (VES) application requires to complete the VES GSPS and PPS.

The Requested Attributes Sequence may contain a maximum of 15 sequence items. This sequence will only appear in the image header if the VES/HES option is installed or PPS is enabled..

9 Structured Report Information Object Implementation

GEHC CT system supports 2 types of SRs, Enhanced SR and X-ray Radiation Dose SR. Both of them support following attributes.

9.1 IOD Module Table

Entity Name	Module Name	Reference	Usage
Patient	Patient	A.3.1	M
Study	General Study	A.3.2	M
	Patient Study	A.3.3	U
Series	SR Document Series	9.2	M
Equipment	General Equipment	A.3.5	M
	Enhanced Equipment	9.3	M
Document	SR Document General	9.4	M
	SR Document Content	9.5	M
	SOP Common	A.3.8	M

9.2 SR Document Series Module

Attribute Name	Tag	Type	Notes
Modality	(0008,0060)	1	Sent as "SR"
Series Instance UID	(0020,000E)	1	Sent.
Series Number	(0020,0011)	1	Sent as "997"
Referenced Performed Procedure Step Sequence	(0008,1111)	2	Sent with one item.

9.3 Enhanced Equipment Model Implementation

The fields that are filled in this module are Manufacturer, Manufacturer's Model Name and Software version. The Device Serial Number field is set as empty String.

Attribute Name	Tag	Type	Notes
Manufacture	(0008,0070)	1	Always sent
Manufacturer's Model Name	(0008,1090)	1	Always sent
Device Serial Number	(0008,1000)	1	Sent as empty
Software Version	(0018,1020)	1	Always sent

9.4 SR Document General Module

Attribute Name	Tag	Type	Notes
Instance Number	(0020,0013)	1	Sent
Completion Flag	(0040,A491)	1	COMPLETE sent
Completion Flag Description	(0040,A492)	3	Sent empty
Verification Flag	(0040,A493)	1	UNVERIFIED sent
Content Date	(0008,0023)	1	Sent
Content Time	(0008,0033)	1	Sent
Verifying Observer Sequence	(0040,A073)	1C	Not sent per conditional
>Verifying Observer Name	(0040,A075)	1	Not sent
>Verifying Observer Identification Code Sequence	(0040,A088)	2	Not sent
<i>>>Include 'Code Sequence Macro' Table 8.8-1</i>			Not sent
>Verifying Organization	(0040,A027)	1	Not sent
>Verification DateTime	(0040,A030)	1	Not sent
Author Observer Sequence	(0040,A078)	3	Not sent
<i>>Include 'Identified Person or Device Macro' Table C.17-3b</i>			
Participant Sequence	(0040,A07A)	3	Not sent
>Participation Type	(0040,A080)	1	Not sent
>Participation DateTime	(0040,A082)	2	Not sent
<i>>Include 'Identified Person or Device Macro' Table C.17-3b</i>			
Custodial Organization Sequence	(0040,A07C)	3	Not sent
>Institution Name	(0008,0080)	2	Not sent
>Institution Code Sequence	(0008,0082)	2	Not sent
<i>>>Include 'Code Sequence Macro' Table 8.8-1</i>			
Predecessor Documents Sequence	(0040,A360)	1C	Not sent per condition
<i>>Include ' Hierarchical SOP Instance Reference Macro' Table C.17-3</i>			
Identical Documents Sequence	(0040,A525)	1C	Not sent per condition
<i>>Include ' Hierarchical SOP Instance Reference Macro' Table C.17-3</i>			
Referenced Request Sequence	(0040,A370)	1C	Not sent per condition

>Study Instance UID	(0020,000D)	1	Not Sent
>Referenced Study Sequence	(0008,1110)	2	Not Sent
>> <i>Include 'SOP Instance Reference Macro' Table 10-11</i>			
>Accession Number	(0008,0050)	2	Not Sent
>Placer Order Number/Imaging Service Request	(0040,2016)	2	Not Sent
>Filler Order Number/Imaging Service Request	(0040,2017)	2	Not Sent
>Requested Procedure ID	(0040,1001)	2	Not Sent
>Requested Procedure Description	(0032,1060)	2	Not Sent
>Requested Procedure Code Sequence	(0032,1064)	2	Not Sent
>> <i>Include 'Code Sequence Macro' Table 8.8-1</i>		<i>No Baseline Context ID Number is specified.</i>	
>Reason for the Requested Procedure	(0040,1002)	3	Not Sent
>Reason for Requested Procedure Code Sequence	(0040,100A)	3	Not Sent
>> <i>Include 'Code Sequence Macro' Table 8.8-1</i>		<i>No Baseline Context ID Number is specified.</i>	
Performed Procedure Code Sequence	(0040,A372)	2	Sent empty
> <i>Include 'Code Sequence Macro' Table 8.8-1</i>		<i>No Baseline Context ID Number is specified.</i>	
Current Requested Procedure Evidence Sequence	(0040,A375)	1C	Not Sent
> <i>Include ' Hierarchical SOP Instance Reference Macro' Table C.17-3</i>			
Pertinent Other Evidence Sequence	(0040,A385)	1C	Not sent
> <i>Include ' Hierarchical SOP Instance Reference Macro' Table C.17-3</i>			
Referenced Instance Sequence	(0008,114A)	1C	Not sent
> <i>Include 'SOP Instance Reference Macro' Table 10-11</i>			
>Purpose of Reference Code Sequence	(0040,A170)	1	Not sent
>> <i>Include 'Code Sequence Macro' Table 8.8-1</i>			

9.5 SR Document Content Module

The tables below capture notes concerning the values stored.

9.5.1 TID 10011 – CT Radiation Dose

	NL	Rel with Parent	VT	Concept Name	VM	Req Type	Notes
1			CONTAINER	EV (113701, DCM, "X-Ray Radiation Dose Report")	1	M	Sent
2	>	HAS CONCEPT MOD	CODE	EV (121058, DCM, "Procedure reported")	1	M	Code sequence (P5-08000, SRT, Computed Tomography X-Ray) sent
3	>>	HAS CONCEPT MOD	CODE	EV (G-C0E8, SRT, "Has Intent")	1	M	Code sequence (R-408C3, SRT, Diagnostic Intent) sent
4	>		INCLUDE	DTID (1002) Observer Context	1-n	M	See TID 1002 Observer context (sent with Device context values equal to Implementation UID. Device Role in Procedure code sequences (113859, DCM, Irradiating Device) and (121097, DCM, Recording) sent. Single item sent.)
5	>	HAS OBS CONTEXT	DATETIME	EV (113809, DCM, "Start of X-Ray Irradiation")	1	M	Sent
6	>	HAS OBS CONTEXT	DATETIME	EV (113810, DCM, "End of X-Ray Irradiation")	1	M	Sent
7	>	HAS OBS CONTEXT	CODE	EV (113705, DCM, "Scope of Accumulation")	1	M	Code sequence (113014, DCM, Study) sent
8	>>	HAS PROPERTIES	UIDREF	DCID (10001) UID Types	1	M	Study Instance UID sent
9	>	CONTAINS	INCLUDE	DTID (10012) CT Accumulated Dose Data	1	M	See TID 10012 CT Accumulated Dose Data table below for details
10	>	CONTAINS	INCLUDE	DTID (10013) CT Irradiation Event Data	1-n	M	See TID 10013 CT Irradiation Event Data table below for details
11	>	CONTAINS	TEXT	EV (121106, DCM, "Comment")	1	U	Not sent
12	>	CONTAINS	CODE	EV (113854, DCM, "Source of Dose Information")	1-n	M	Code sequence (113856, DCM, Automated Data Collection) sent

13	>	CONTAINS	INCLUDE	DTID (1020) Person Participant	1	U	Not sent.
----	---	----------	---------	--------------------------------------	---	---	-----------

9.5.2 TID 10012 – CT Accumulated Dose Data

	NL	Rel with Parent	VT	Concept Name	VM	Req Type	Notes
1			CONTAINER	EV (113811, DCM, "CT Accumulated Dose Data")	1	M	Sent
2	>	CONTAINS	NUM	EV (113812, DCM, "Total Number of Irradiation Events")	1	M	Sent
3	>	CONTAINS	NUM	EV (113813, DCM, "CT Dose Length Product Total")	1	M	Sent
4	>	CONTAINS	NUM	EV (113814, DCM, "CT Effective Dose Total")	1	U	Not sent
5	>>	HAS PROPERTIES	TEXT	EV (121406,DCM, "Reference Authority")	1	MC	Not sent
6	>>	HAS PROPERTIES	CODE	EV (121406,DCM, "Reference Authority")	1	MC	Not sent
7	>>	HAS CONCEPT MOD	CODE	EV (G-C036,SRT, "Measurement Method")	1	M	Not sent
8	>>	HAS PROPERTIES	TEXT	EV (113815,DCM, "Patient Model")	1	MC	Not sent
9	>>	HAS PROPERTIES	CONTAINER	EV (113816, DCM, "Condition Effective Dose measured")	1	MC	Not sent
10	>>>	CONTAINS	TEXT	EV (113817,DCM, "Effective Dose Phantom Type")	1	M	Not sent
11	>>>	CONTAINS	TEXT	EV (113818,	1	M	Not sent

				DCM, "Dosimeter Type")			
12	>	CONTAINS	TEXT	EV (121106, DCM, "Comment")	1	U	Not sent
13	>	CONTAINS	INCLUDE	DTID(1021) Device Participant	1	MC	Not sent

9.5.3 TID 10013 – CT Irradiation Event Data

	NL	Rel with Parent	VT	Concept Name	VM	Req Type	Notes
1			CONTAINER	EV (113819, DCM, "CT Acquisition")	1	M	Sent
2	>	CONTAINS	TEXT	EV (125203, DCM, "Acquisition Protocol")	1	U	Sent; same as Protocol Name (0018,1030) Note: In case of multiple protocols selected in one exam, last protocol selected by operator will be set for each irradiation event.
3	>	CONTAINS	CODE	EV (123014 , DCM, "Target Region")	1	M	Sent. See note below for specifics. Note: In case of multiple protocols selected in one exam, target region for last protocol selected by operator will be set for each irradiation event.
4	>	CONTAINS	CODE	EV (113820, DCM, "CT Acquisition Type")	1	M	Sent
5	>	CONTAINS	CODE	(G-C32C, SRT, "Procedure Context")	1	U	Not sent
6	>	CONTAINS	UIDREF	EV (113769, DCM, "Irradiation Event UID")	1	M	Sent; all images from this irradiation event contain same Irradiation Event UID (0x0008, 0x3010)
7	>	CONTAINS	CONTAINER	EV (113822, DCM, "CT Acquisition Parameters")	1	M	Sent
8	>>	CONTAINS	NUM	EV (113824, DCM, "Exposure Time")	1	M	Sent

9	>>	CONTAINS	INCLUDE	DTID(10014) Scanning Length	1	M	See TID 10014 Scanning Length table below for details
10	>>	CONTAINS	NUM	EV (113826, DCM, "Nominal Single Collimation Width")	1	M	Sent
11	>>	CONTAINS	NUM	EV (113827, DCM, "Nominal Total Collimation Width")	1	M	Sent
12	>>	CONTAINS	NUM	EV (113828, DCM, "Pitch Factor")	1	MC	Sent per conditional
13	>>	CONTAINS	NUM	EV (113823, DCM, "Number of X-Ray Sources")	1	M	Sent
14	>>	CONTAINS	CONTAINER	EV (113831, DCM, "CT X-Ray Source Parameters")	1-n	M	Single item sent.
15	>>>	CONTAINS	TEXT	EV (113832, DCM, "Identification of the X-Ray Source")	1	M	Sent
16	>>>	CONTAINS	NUM	EV (113733, DCM, "KVP")	1	M	Sent
17	>>>	CONTAINS	NUM	EV (113833, DCM, "Maximum X-Ray Tube Current")	1	M	Sent
18	>>>	CONTAINS	NUM	EV (113734, DCM, "X-Ray Tube Current")	1	M	Sent
19	>>>	CONTAINS	NUM	EV (113834, DCM, "Exposure Time per Rotation")	1	MC	Sent per conditional
20	>>>	CONTAINS	NUM	EV (113821, DCM, "X-Ray Filter Aluminum Equivalent")	1	U	Not sent
21	>	CONTAINS	CONTAINER	EV (113829, DCM, "CT Dose")	1	MC	Sent per conditional
22	>>	CONTAINS	NUM	EV (113830, DCM, "Mean CTDIvol ")	1	M	Sent
23	>>	CONTAINS	CODE	EV (113835, DCM, "CTDIw Phantom	1	M	Sent (IEC Head Dosimetry Phantom or IEC Body

				Type")			Dosimetry Phantom)
24	>>	CONTAINS	NUM	EV (113836, DCM, "CTDIfreeair Calculation Factor")	1	U	Not sent
25	>>	CONTAINS	NUM	EV (113837, DCM, "Mean CTDIfreeair")	1	U	Not sent
26	>>	CONTAINS	NUM	EV (113838, DCM, "DLP")	1	M	Sent
27	>>	CONTAINS	NUM	EV (113839, DCM, "Effective Dose")	1	U	Not sent
28	>>>	HAS CONCEPT MOD	CODE	EV (G-C036, SRT, "Measurement Method")	1	MC	Not sent
29	>>>>	HAS PROPERTIES	NUM	EV (113840, DCM, "Effective Dose Conversion Factor")	1	MC	Not sent
30	>>	CONTAINS	INCLUDE	DTID(10015) CT Dose Check Details	1	M	See TID 10015 CT Dose Check Details table below for details
31	>	CONTAINS	TEXT	EV (113842, DCM, "X-Ray Modulation Type")	1	U	Not sent
32	>	CONTAINS	TEXT	EV (121106, DCM, "Comment")	1	U	Not sent
33	>	CONTAINS	INCLUDE	DTID (1020) Person Participant	1-n	U	Not sent
34	>	CONTAINS	INCLUDE	DTID (1021) Device Participant	1	MC	Not sent.

9.5.4 TID 10014 - Scanning Length

	NL	Rel with Parent	VT	Concept Name	VM	Req Type	Notes
1			NUM	EV(113825, DCM, "Scanning Length")	1	M	Sent
2			NUM	EV(113893, DCM, "Length of	1	U	Sent, except not sent for Scout

				Reconstructable Volume")			
3			NUM	EV(113899, DCM, "Exposed Range")	1	UC	Sent per conditional
4			NUM	EV(113895, DCM, "Top Z Location of Reconstructable Volume")	1	U	Sent, except not sent for Scout
5			NUM	EV(113896, DCM, "Bottom Z Location of Reconstructable Volume")	1	U	Sent, except not sent for Scout
6			NUM	EV(113897, DCM, "Top Z Location of Scanning Length")	1	U	Sent
7			NUM	EV(113898, DCM, "Bottom Z Location of Scanning Length")	1	U	Sent
8			UIDREF	EV(112227, DCM, "Frame of Reference UID")	1	MC	Sent

9.5.5 TID 10015 - CT Dose Check Details

	NL	Rel with Parent	VT	Concept Name	VM	Req Type	Notes
1			CONTAINER	EV(113900, DCM, "Dose Check Alert Details")	1	MC	Sent
2	>	CONTAINS	CODE	EV(113901, DCM, "DLP Alert Value Configured")	1	M	Sent
3	>	CONTAINS	CODE	EV(113902, DCM, "CTDIvol Alert Value Configured")	1	M	Sent
4	>	CONTAINS	NUM	EV(113903, DCM, "DLP Alert Value")	1	MC	Sent per conditional
5	>	CONTAINS	NUM	EV(113904, DCM, "CTDIvol Alert Value")	1	MC	Sent per conditional
6	>	CONTAINS	NUM	EV(113905, DCM, "Accumulated	1	MC	Sent per conditional

				DLP Forward Estimate")			
7	>	CONTAINS	NUM	EV(113906, DCM, "Accumulated CTDIvol Forward Estimate")	1	MC	Sent per conditional
8	>	CONTAINS	TEXT	EV(113907, DCM, "Reason for Proceeding")	1	UC	Sent per conditional
9	>	CONTAINS	INCLUDE	DTID(1020) Person Participant	1	MC	Sent per conditional. See TID 1020 Person Participant table below for details
10			CONTAINER	EV(113908, DCM, "Dose Check Notification Details")	1	MC	Sent
11	>	CONTAINS	CODE	EV(113909, DCM, "DLP Notification Value Configured")	1	M	Sent
12	>	CONTAINS	CODE	EV(113910, DCM, "CTDIvol Notification Value Configured")	1	M	Sent
13	>	CONTAINS	NUM	EV(113911, DCM, "DLP Notification Value")	1	MC	Sent per conditional
14	>	CONTAINS	NUM	EV(113912, DCM, "CTDIvol Notification Value")	1	MC	Sent per conditional
15	>	CONTAINS	NUM	EV(113913, DCM, "DLP Forward Estimate")	1	MC	Sent per conditional
16	>	CONTAINS	NUM	EV(113914, DCM, "CTDIvol Forward Estimate")	1	MC	Sent per conditional
17	>	CONTAINS	TEXT	EV(113907, DCM, "Reason for Proceeding")	1	UC	Sent per conditional
18	>	CONTAINS	INCLUDE	DTID(1020) Person Participant	1	UC	Not sent

9.5.6 TID 1002 – Observer Context

	NL	Rel with Parent	VT	Concept Name	VM	Req Type	Note
1		HAS OBS CONTEXT	CODE	EV (121005,DCM, "Observer Type")	1	MC	Sent as "Device".
2		HAS OBS CONTEXT	INCLUDE	DTID (1003) Person observer identifying attributes	1	MC	Not sent.
3		HAS OBS CONTEXT	INCLUDE	DTID (1004) Device observer identifying attributes	1	MC	See TID 1004 Device Observer Identifying Attributes table below for details.

9.5.7 TID 1004 – Device Observer Identifying Attributes

	NL	Rel with Parent	VT	Concept Name	VM	Req Type	Note
1			UIDREF	EV (121012,DCM, "Device Observer UID")	1	M	Sent. Same as Implementation UID (0002,0012) See Appendix.D.
2			TEXT	EV (121013,DCM, "Device Observer Name")	1	U	Sent. Same as Station Name (0008,1010)
3			TEXT	EV (121014,DCM, "Device Observer Manufacturer")	1	U	Sent as "GE Medical Systems".
4			TEXT	EV (121015,DCM, "Device Observer Model Name")	1	U	Sent. Same as Manufacturer's Model Name (0008,1090)
5			TEXT	EV (121016,DCM, "Device Observer Serial Number")	1	U	Sent. Same as Device Serial Number (0018,1000)
6			TEXT	EV (121017,DCM, "Device Observer Physical Location during observation")	1	U	Not Sent.
7			CODE	EV (113876, DCM, "Device Role in Procedure")	1-n	U	Sent as "Irradiating Device" and "Recording".

9.5.8 TID 1020 – Person Participant

	NL	Rel with Parent	VT	Concept Name	VM	Req Type	Note
1			PNAME	EV (113870,DCM, "Person Name")	1	M	Sent Person's name is free text, not PNAME format.

2	>	HAS PROPERTIES	CODE	EV (113875,DCM, "Person Role in Procedure")	1	M	Sent as "Irradiation Authorizing".
3	>	HAS PROPERTIES	TEXT	EV (113871,DCM, "Person ID")	1	U	Sent.
4	>	HAS PROPERTIES	TEXT	EV (113872,DCM, "Person ID Issuer")	1	U	Not Sent.
5	>	HAS PROPERTIES	TEXT	EV (113873,DCM, "Organization Name")	1	U	Not Sent.
6	>	HAS PROPERTIES	CODE	EV (113874,DCM, "Person Role in Organization")	1	U	Not Sent.

Note: Target region is filled in per the following table:

Protocol Category	Value stored in Target Region
Head	SRT T-D1100 Head
Orbit	SRT T-D0801 Eye region
Neck	SRT T-D1600 Neck
Upper Extremity	SRT T-02220 Shoulder
Chest	SRT T-D3000 Chest
Abdomen	SRT T-D4000 Abdomen
Spine	SRT T-11503 Lumbar spine
Pelvis	SRT T-D6000 Pelvis
Lower Extremity	SRT T-D0300 Extremity

Note: CT X-Ray Radiation Dose SR Record adheres to the DICOM 2011 edition.

9.6 Configuration

The product is configured by default to not generate the CT X-Ray Radiation Dose SR Record. Creation of the CT Dose Record can be enabled via reconfig.

The product implements the CT Radiation Dose Report template (TID 10011) per DICOM Supplement 127.

The DICOM standard says that the SOP class shall be the "X-Ray Radiation Dose SR" SOP Class (1.2.840.10008.5.1.4.1.1.88.67).

However, since many products may not support this SOP class, the product supports the option via reconfig to create the CT Radiation Dose Report as an "Enhanced SR" SOP Class (1.2.840.10008.5.1.4.1.1.88.22).

SR setting can be configured in "Dose Report" in reconfig menu as below.

- "Full" will produce the X-Ray Radiation Dose SR SOP class

- “On” will produce the Enhanced SR SOP class.
- “Off” will not produce any SOP class.

10 Security Conformance Statement

10.1 De-identification

The GEHC CT system satisfies the following requirements for de-identification. De-identification occurs, for example, when an anonymous patient operation is performed. This de-identification only covers DICOM attributes that contain protected patient information. The encrypted data capability is not supported, so once an image has been de-identified no facility is provided to recover the lost information.

The de-identification specified in this section only applies to GE generated images. All third party images have only the standard DICOM elements de-identified, all private tags (non-GE private tags) within these images are dropped.

De-identification supports the following object types:

- CT Image Objects

De-identification does not support the following object types:

- Secondary capture images
- Structured reports
- Grayscale presentation state objects

This de-identification specification applies when the GEHC CT system is configured for full de-identification. If the system is configured for partial de-identification, some attributes will remain unchanged.

Please note that Study ID (0020,0010) will be retained in anonymized images.

Table 10.1-1 provides the list of attributes and the expected action when de-identifying images.

**Table 10.1-1
 DICOM Attributes De-Identified**

DICOM Tag	Attribute Name	Action	Comments
0008,0014	Instance Creator UID	element dropped	Refer to Note 1
0008,0018	SOP Instance UID	assign new UID	
0008,0050	Accession Number	made zero length	
0008,0080	Institution Name	made zero length	
0008,0081	Institution Address	element dropped	Refer to Note 1
0008,0090	Referring Physician’s Name	made zero length	

DICOM Tag	Attribute Name	Action	Comments
0008,0092	Referring Physician's Address	element dropped	Refer to Note 1
0008,0094	Referring Physician's Telephone Numbers	element dropped	Refer to Note 1
0008,1010	Station Name	"ANONYMIZED"	
0008,1030	Study Description	"ANONYMIZED"	
0008,103E	Series Description	"ANONYMIZED"	
0008,1040	Institutional Department Name	element dropped	Refer to Note 1
0008,1048	Physicians of Record	element dropped	Refer to Note 1
0008,1050	Performing Physicians' Name	element dropped	Refer to Note 1
0008,1060	Name of Physicians Reading Study	made zero length	
0008,1070	Operators' Name	made zero length	
0008,1080	Admitting Diagnoses Description	element dropped	Refer to Note 1
0008,1110	Referenced Study Sequence	drop sequence	
>0008,1150	Referenced SOP Class UID	element dropped	
>0008,1155	Referenced SOP Instance UID	element dropped	
0008,1140	Referenced Image Sequence	drop sequence	Special handling is performed when the entire exam is de-identified in one operation. See Table 10.1-2 for details.
>0008,1150	Referenced SOP Class UID	element dropped	
>0008,1155	Referenced SOP Instance UID	element dropped	
0010,0010	Patient's Name	"ANONxxxx"	xxxx = study id
0010,0020	Patient ID	"ANONxxxx"	xxxx = study id
0010,0030	Patient's Birth Date	made zero length	
0010,0032	Patient's Birth Time	element dropped	Refer to Note 1
0010,0040	Patient's Sex	made zero length	
0010,1000	Other Patient Ids	made zero length	
0010,1001	Other Patient Names	element dropped	Refer to Note 1
0010,1010	Patient's Age	made zero length	
0010,1020	Patient's Size	made zero length	
0010,1030	Patient's Weight	made zero length	
0010,1090	Medical Record Locator	element dropped	Refer to Note 1
0010,2160	Ethnic Group	element dropped	Refer to Note 1
0010,2180	Occupation	element dropped	Refer to Note 1
0010,21B0	Additional Patient's History	made zero length	
0010,4000	Patient Comments	element dropped	Refer to Note 1
0018,1000	Device Serial Number	made zero length	
0018,1030	Protocol Name	made zero length	
0020,000D	Study Instance UID	assign new UID	This value is used for all images in exam

DICOM Tag	Attribute Name	Action	Comments
0020,000E	Series Instance UID	assign new UID	This value is used for all images in series
0020,0010	Study ID	retain Study ID	This value is used in patient ID
0020,0052	Frame of Reference UID	assign new UID	This value is used for all images sharing this UID
0020,0200	Synchronization Frame of Reference UID	element dropped	Refer to Note 1
0020,0400	Image Comments	made zero length	Refer to Note 1
0040,0275	Request Attributes Sequence	retain the sequence	
0040,A124	UID	element dropped	Refer to Note 1
0040,A730	Content Sequence	drop sequence	Refer to Note 1
0088,0140	Storage Media File-set UID	element dropped	Refer to Note 1
3006,0024	Referenced Frame of Reference UID	element dropped	Refer to Note 1
3006,00C2	Related Frame of Reference UID	element dropped	Refer to Note 1

Note 1: these elements are not currently present in GE images, however, the described action will occur on 3rd party images.

The following special processing is performed based on image type:

**Table 10.1-2
 De-identification Processing by Image Type**

Image Type	Processing
CT Image	de-identified based on the tables above
SC Image	image discarded
GSPS	object discarded
SR	object discarded

10.2 ASSOCIATION LEVEL SECURITY

The GEHC CT system provides association level security for Query Retrieve operations. The system will only allow remote DICOM servers to pull images if the remote DICOM server is defined on the GEHC CT system. The remote DICOM server's IP address, AE title, and Port number must be configured on the GEHC CT system for the networking pull to begin.

Note that this association level security only applies to the retrieve request; query operations will be accepted from any connected DICOM client.

APPENDIX A: CT Image and Secondary Capture

The tables below specify the modules/attributes of the CT Image and Secondary Capture Image transmitted by the Storage SCU AE.

A.1 CT Image IOD

A.1.1 CT Image IOD Modules

Entity Name	Module Name	Reference	Usage
Patient	Patient	A.3.1	M
Study	General Study	A.3.2	M
	Patient Study	A.3.3	U
Series	General Series	A.3.4	M
Frame of Reference	Frame of Reference	A.4.5	M
Equipment	General Equipment	A.3.5	M
Image	General Image	A.3.6	M
	Image Plane	A.4.1	M
	Image Pixel	A.4.2	M
	Contrast/Bolus	A.4.3	C
	CT Image	A.4.4	M
	VOI LUT	A.3.7	U
	SOP Common	A.3.8	M

A.1.1.1 Implementation Specific details

- For all CT Images created by GEHC CT patient birth date element (0010,0030) is sent, if the operator has entered the details. If the operator has not entered the details it will be sent as a “Zero length element”
- The length of Accession number element (0008,0050) is a maximum of 16 characters
 - Window Center (0028,1050) and Window Width (0028,1051) are sent for all CT Images created by GEHC CT
 - Based on whether contrast was used or not the following applies for CT Images created by GEHC CT

Mode	(0018,0010)	(0018,1040)
No Contrast	Not sent	Not sent
Oral Contrast	Oral Contrast Agent name	The string “Oral”
IV Contrast	IV Contrast agent name	The String “IV”
Oral and IV contrast	Oral contrast agent “ & “ IV Contrast agent	The string “Oral & IV”

- Supported field length for DICOM fields

DICOM Tag	Field Name	Field Length
(0008, 0050)	Accession Number	16 characters
(0010, 0010)	Patient Name	32 characters (configurable to 64)
(0010, 0020)	Patient Id	16 characters (configurable to 64)

A.2 SC Image IOD

A.2.1 SC Image IOD Modules

Entity Name	Module Name	Reference	Usage
Patient	Patient	A.3.1	M
Study	General Study	A.3.2	M
	Patient Study	A.3.3	U
Series	General Series	A.3.4	M
	General Equipment	A.3.5	U

	SC Equipment	A.5.1	M
Image	General Image	A.3.6	M
	Image Pixel	A.5.2	M
	SC Image	Not sent (consists entirely of type 3 element).	M
	Modality LUT	A.5.3	U
	VOI LUT	A.3.7	U
	SOP Common	A.3.8	M

A.2.2 CT Dose Report SC Image Details

The product is configured by default to generate a CT X-Ray Radiation Dose Report SC Image summarizing the study dose. The pixel data contains a textual, viewable report of the dose information. The next section identifies the additional standard DICOM attributes added to capture the same information as reported in the CT X-Ray Radiation Dose Record, described in Section 9.

A.2.2.1 Implementation Specific details

Attribute Name	Tag	Type	Notes
Total Number of Exposures	(0040,0301)	3	Total number of exposures made during this Performed Procedure Step.
Exposure dose sequence	(0040,030E)	3	Exposure Dose Sequence will contain Total Number of Exposures (0040,0301) items.
>kVp	(0018,0060)	3	Peak kilo voltage output
>X-Ray Tube Current	(0018,8151)	3	X-Ray tube current in microA. NOTE: the X-Ray Radiation Dose SR records this in mA.
>Exposure Time	(0018,1150)	3	Time of x-ray exposure in msec.
>Acquisition Type	(0018,9302)	3	
>CTDIvol	(0018,9345)	3	Computed Tomography Dose Index in mGy according to IEC 60601-2-44.
>CTDI Phantom Type Code Seq	(0018,9346)	3	The type of phantom used for CTDI measurement according to IEC 60601-2-44.
>Single Collimation Width	(0018,9306)	3	The width of a single row of acquired data in mm.
>Total Collimation	(0018,9307)	3	The width of the total collimation in mm over the area of active x-ray detection.
>Spiral Pitch Factor	(0018,9311)	3	Ratio of the Table Feed per Rotation (0092,9310) to the Total Collimation Width (0018,9307)
>Body Part Examined	(0018,0015)	3	Text description of the part of the body examined. See the values for target region at the end of section 9.4.3 for the values stored.
Comments on Radiation Dose	(0040,0310)	3	Used to record total and per exposure DLP. The format is: TotalDLP=xxx DLP=xxx DLP=xxx

A.3 Common Modules

A.3.1 Patient Module

Attribute Name	Tag	Type	Notes
Patient's Name	(0010,0010)	2	As entered at user interface or from worklist. Supports 5 different components delimited by "^". Supports a maximum length of 32 characters including the delimiter. Can be configured to allow 64 characters.
Patient ID	(0010,0020)	2	As entered at user interface or from worklist. Supports maximum of 16 characters. Can be configured to allow 64 characters.
Patient's Birth Date	(0010,0030)	2	As entered at user interface or from worklist.
Patient's Sex	(0010,0040)	2	As entered at user interface or from worklist.
Referenced Patient Sequence	(0008,1120)	3	Value from the worklist
>Referenced SOP Class UID	(0008,1150)	1C	Value from the worklist
>Referenced SOP Instance UID	(0008,1155)	1C	Value from the worklist
Other Patient ID	(0010,1000)	3	Value from the worklist

A.3.2 General Study Module

Attribute Name	Tag	Type	Notes
Study Instance UID	(0020,000D)	1	Value from worklist, if present, is used. Otherwise, the scanner creates a unique value for each exam. If worklist is reused, system can be configured to reuse the study instance uid. Default behavior is to generate a new study instance uid if the worklist is reused.
Study Date	(0008,0020)	2	Generated for each exam and always sent.
Study Time	(0008,0030)	2	Generated for each exam and always sent.

Attribute Name	Tag	Type	Notes
Accession Number	(0008,0050)	2	Value from user interface or worklist sent. If worklists with different accession numbers are grouped, the default behavior is to fill in the top level accession number in the image header. The accession number can be configured to be empty in the grouped case.
Referring Physician's Name	(0008,0090)	2	Value from user interface sent. Accepts 32 characters by default but is configurable to accept 64 characters.
Study ID	(0020,0010)	2	Generated for each exam on the scanner and always sent..
Study Description	(0008,1030)	3	Value from user interface or worklist sent. Accepts 22 characters by default but is configurable to accept 64 characters.
Name of Physician(s) Reading Study	(0008,1060)	3	Sent if entered at the user interface.
Referenced Study Sequence	(0008,1110)	3	Value from the worklist
>Referenced SOP Class UID	(0008,1150)	1C	Value from the worklist
>Referenced SOP Instance UID	(0008,1155)	1C	Value from the worklist

A.3.3 Patient Study Module

Attribute Name	Tag	Type	Notes
Patient's Age	(0010,1010)	3	Calculated from Date of Birth entered at user interface.
Patient's Size	(0010,1020)	3	Value from user interface or worklist sent
Patient's Weight	(0010,1030)	3	Value from user interface or worklist sent.
Additional Patient's History	(0010,21b0)	3	Value from user interface or worklist sent

A.3.4 General Series Module

Attribute Name	Tag	Type	Notes
----------------	-----	------	-------

Series Number	(0020,0011)	2	Generated sequentially, always sent.
Laterality	(0020,0060)	2C	Always sent zero-length.
Series Date	(0008,0021)	3	Generated for each series and always sent.
Series Time	(0008,0031)	3	Generated for each series and always sent.
Modality	(0008,0060)	1	Always sent as "CT"
Performing Physician's Name	(0008,1050)	3	Mapped from (0040, 0006) in the worklist.
Protocol Name	(0018,1030)	3	Sent if entered at user interface.
Series Description	(0008,103E)	3	Value from user interface is sent.
Operator's Name	(0008,1070)	3	Value from user interface is sent.
Patient Position	(0018,5100)	2C	Sent. As selected by operator when patient is positioned. Defined terms are: HFP = Head-First Prone HFS = Head-First Supine HFDR = Head-First Decubitus Right HFDL = Head-First Decubitus Left FFDR = Feet-First Decubitus Right FFDL = Feet-First Decubitus Left FFP = Feet-First Prone FFS = Feet-First Supine
Series Instance UID	(0020,000E)	1	Always sent
Performed Procedure Step Start Date	(0040,0244)	3	Sent when MPPS option is enabled
Performed Procedure Step Start Time	(0040,0245)	3	Sent when MPPS option is enabled
Performed Procedure Step ID	(0040,0253)	3	Sent when MPPS option is enabled
Performed Procedure Step Description	(0040,0254)	3	Sent when MPPS option is enabled
Requested Attributes Sequence	(0040,0275)	3	Sent when MPPS option is enabled and filled in based on what RIS provides to scanner. Number of items relates to number of items selected from Patient Schedule.
> Requested Procedure ID	(0040,1001)	1C	Always sent, copied from RIS
> Accession Number	(0008,0050)	3	Value from worklist sent
> Referenced Study Sequence	(0008,1110)	3	Value from worklist sent
> Study Instance UID	(0020,000D)	3	Value from worklist sent
> Requested	(0032,1060)	3	Value from worklist sent

Procedure Desc			
> Requested Procedure Code Sequence	(0032,1064)	3	Value from worklist sent
> Scheduled Procedure Step Desc	(0040,0007)	3	Value from worklist sent
> Scheduled Protocol Code Sequence	(0040,0008)	3	Value from worklist sent
> Scheduled Procedure Step ID	(0040,0009)	3	Value from worklist sent
> Reason for Requested Procedure	(0040,1002)	3	Value from worklist sent
> Reason for Requested Procedure Code sequence	(0040,1004)	3	Value from worklist sent
Body Part Examined	(0018,0015)	3	Only sent for GSI CT images.
Referenced Performed Procedure Step Sequence	(0008,1111)	3	Value used for performed procedure step
>Referenced SOP Class UID	(0008,1150)	1C	Value used for performed procedure step
>Referenced SOP Instance UID	(0008,1155)	1C	Value used for performed procedure step

A.3.5 General Equipment Module

Attribute Name	Tag	Type	Notes
Manufacturer	(0008,0070)	2	Always sent as "GE MEDICAL SYSTEMS"
Institution Name	(0008,0080)	3	Sent. Value is configurable.
Station Name	(0008,1010)	3	Sent. Value is configurable.
Manufacturers Model Name	(0008,1090)	3	Sent.
Device Serial Number	(0018,1000)	3	Sent, Using Gantry Serial number from Product Locator tool.
Software Versions	(0018,1020)	3	Sent.
Pixel Padding Value	(0028,0120)	3	Sent.

A.3.6 General Image Module

Attribute Name	Tag	Type	Notes
Image Number	(0020,0013)	2	Generated sequentially, always sent.

Patient Orientation	(0020,0020)	2C	Always sent zero length for SC images.
Image Date	(0008,0023)	2C	Generated for each image, always sent.
Image Time	(0008,0033)	2C	Generated for each image, always sent.
Image Type	(0008,0008)	3	<p>Always sent.</p> <p>Value 3: CT Image IOD specific specializations</p> <p>AXIAL</p> <p>LOCALIZER</p> <p>SEGMENTED</p> <p>REFORMATTED</p> <p>PROCESSED</p> <p>COMBINED</p> <p>CTINTERVENTION</p> <p>Value 4: GE CT Image implementation specific</p> <p>MIN IP</p> <p>MIP</p> <p>AVERAGE</p> <p>VOLREN</p> <p>INTEGRAL</p> <p>HD MIP</p> <p>RAYSUM</p> <p>SURFACE</p> <p>MINMAX</p> <p>FLUORO</p> <p>GSI MONO</p> <p>GSI HIGH KV</p> <p>GSI LOW KV</p> <p>GSI MD</p> <p>GSI QC</p> <p>GSI EFF Z</p> <p>GSI CLR OVRLY</p> <p>DIGITALTILT</p>
Acquisition Number	(0020,0012)	3	Generated for each acquisition, always sent.
Acquisition Date	(0008,0022)	3	Generated for each acquisition, always sent.
Acquisition Time	(0008,0032)	3	Generated for each acquisition, always sent. Format is in fractional seconds as small as 1 millionth of a second.
Referenced Image	(0008,1140)	3	Value from the worklist

Sequence			
>Reference SOP Class UID	(0008,1150)	1	Value from the worklist
>Reference SOP Instance UID	(0008,1155)	1	Value from the worklist
Irradiation Event UID	(0008,3010)	3	Always sent.

A.3.7 VOI LUT Module

Attribute Name	Tag	Type	Notes
Window Center	(0028,1050)	1C	Window Center for display. Always sent.
Window Width	(0028,1051)	1C	Window Width for display. Always sent.

A.3.8 SOP Common Module

Attribute Name	Tag	Type	Notes
SOP Class UID	(0008,0016)	1	Always sent.
SOP Instance UID	(0008,0018)	1	Always sent.
Specific Character Set	(0008,0005)	1C	ISO_IR 100
Instance Creation Date	(0008,0012)	3	Always sent.
Instance Creation Time	(0008,0013)	3	Always sent.
Instance Number	(0020,0013)	3	Always sent.

A.4 CT Image Modules

A.4.1 Image Plane Module

Attribute Name	Tag	Type	Notes
Slice Thickness	(0018,0050)	2	Value always sent.
Image Slice Location	(0020,1041)	3	Value always sent. Note: Slice Location reflects the gantry ISO center table location value for the image in mm. If the gantry is tilted, this value will differ from the image position (0020, 0032) Z value which reflects the upper left-hand voxel (center of the first voxel transmitted) of the grid, in mm in the registered Frame of Reference. The system can be configured to save the upper left-hand corner Z coordinate value into (0020, 1041) Slice Location instead of the gantry ISO

			center table location.
Image Position	(0020,0032)	1	Always sent. System configuration allows images to be flipped and rotated. Default behavior is to not allow flip and rotate. Note that the Image Position reflects the x, y and z coordinate of the upper left corner of the first voxel transmitted instead of the center of the first voxel transmitted.
Image Orientation	(0020,0037)	1	Always sent. System configuration allows images to be flipped and rotated. Default behavior is to not allow flip and rotate.
Pixel Spacing	(0028,0030)	1	Always sent

A.4.2 Image Pixel Module

Attribute Name	Tag	Type	Notes
Samples per Pixel	(0028,0002)	1	Always sent with value = 1
Photometric Interpretation	(0028,0004)	1	Always sent.
Rows	(0028,0010)	1	Always sent
Columns	(0028,0011)	1	Always sent
Bits Allocated	(0028,0100)	1	Always sent with value = 16
Bits Stored	(0028,0101)	1	Always sent with value = 16
High Bit	(0028,0102)	1	Always sent with value = 15
Pixel Representation	(0028,0103)	1	Always sent with value = 1
Pixel Data	(7FE0,0010)	1	Always sent

A.4.3 Contrast Bolus Module

Attribute Name	Tag	Type	Notes
Contrast/Bolus Agent	(0018,0010)	2	Sent if contrast exam, as entered in user interface.
Contrast/Bolus Route	(0018,1040)	3	Sent if contrast exam, as entered in user interface.

A.4.4 CT Image Module

Attribute Name	Tag	Type	Notes
Image Type	(0008,0008)	1	Always sent. Defined terms:

Attribute Name	Tag	Type	Notes
			Value 3: AXIAL LOCALIZER SEGMENTED REFORMATTED PROCESSED COMBINED CTINTERVENTION Value 4: MIN IP MIP AVERAGE VOLREN INTEGRAL HD MIP RAYSUM SURFACE MINMAX FLUORO GSI MONO GSI HIGH KV GSI LOW KV GSI MD GSI QC GSI EFF Z GSI CLR OVRLY DIGITALTILT
Samples per Pixel	(0028,0002)	1	Always sent with value = 1
Photometric Interpretation	(0028,0004)	1	Always sent
Bits Allocated	(0028,0100)	1	Always sent with value = 16
Bits Stored	(0028,0101)	1	Always sent with value = 16
High Bit	(0028,0102)	1	Always sent with value = 15
Rescale Intercept	(0028,1052)	1	Always sent
Rescale Slope	(0028,1053)	1	Always sent
Rescale Type	(0028,1054)	1C	Always sent with value = HU
KV	(0018,0060)	2	Value always sent.
Acquisition Number	(0020,0012)	2	Value always sent.
Scan Options	(0018,0022)	3	Value always sent.

Attribute Name	Tag	Type	Notes
			<p>Defined Terms :</p> <p>AXIAL MODE SCOUT MODE AXIAL XRON MODE AXIAL XROFF MODE STATIC XRON MODE STATIC XROFF MODE TUBE HEAT MODE DAS MODE TUBE CAL MODE BIOPSY MODE CINE HELICAL ROTGENCAL MODE FLUORO MODE</p>
Data Collection Diameter	(0018,0090)	3	Value always sent.
Reconstruction Diameter	(0018,1100)	3	Value sent for all images except scouts.
Distance Source to Detector	(0018,1110)	3	Value always sent.
Distance Source to Patient	(0018,1111)	3	Value always sent.
Gantry / Detector Tilt	(0018,1120)	3	Value always sent.
Table Height	(0018,1130)	3	Value always sent.
Rotation Direction	(0018,1140)	3	Not sent for scout or axial.
Exposure Time	(0018,1150)	3	Value always sent.
X-Ray Tube Current	(0018,1151)	3	Value always sent.
Exposure	(0018,1152)	3	Value always sent. (See Note below)
Filter Type	(0018,1160)	3	<p>Sent.</p> <p>Defined terms: BODY FILTER MEDIUM FILTER HEAD FILTER</p>
Generator Power	(0018,1170)	3	Always sent
Focal Spot	(0018,1190)	3	Sent. Fixed value of 0.7 or 1.2.
Convolution Kernel	(0018,1210)	3	<p>Not sent for scouts.</p> <p>Defined terms:</p>

Attribute Name	Tag	Type	Notes
			<u>SMOOTH</u> <u>SOFT</u> <u>STANDARD</u> <u>STD+</u> <u>DETAIL</u> <u>BONE</u> <u>BONEPLUS</u> <u>CHST</u> <u>EDGE</u> <u>SHARP</u> <u>LUNG</u> <u>ULTRA</u> <u>HD LUNG</u> <u>STANDARD2</u> <u>DETAIL2</u> <u>BONE2</u> <u>BONEPLUS2</u> <u>EDGE2</u> <u>STANDARDPLUS2</u> <u>DETAILPLUS2</u> <u>HD ULTA</u> <u>HD SOFT</u>
Revolution Time	(0018, 9305)	3	Sent for spiral scan only
Single Collimation Width	(0018, 9306)	3	Sent for spiral scan only
Total Collimation Width	(0018, 9307)	3	Sent for spiral scan only
Table Speed	(0018, 9309)	3	Sent for spiral scan only
Table Feed per Rotation	(0018, 9310)	3	Sent for spiral scan only
CT Pitch Factor	(0018, 9311)	3	Sent for spiral scan only

CAUTION

It is possible for the operator of GEHC CT system to change the table height while scanning a series of images. Therefore, implementations must use the Frame of Reference UID (0020,0052) in conjunction with the Table Height (0018,1130) to determine if two images are spatially related.

Decsription of how to calculate the Dicom Exposure field (0018,1152)

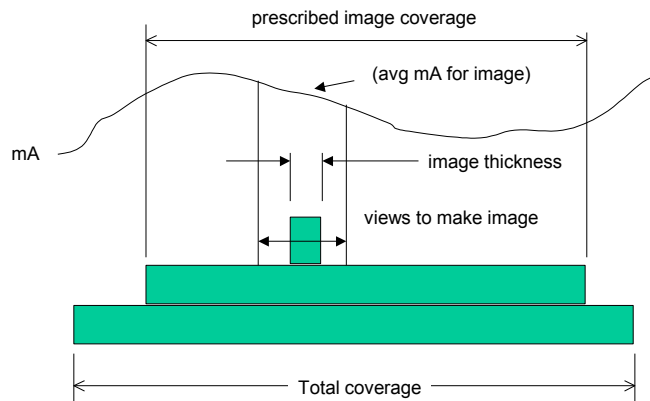

$$\text{exposure} = (\text{exposure time}) * (\text{image avg mA}) * (\text{slice thickness}) / (\text{total coverage})$$

exposure time = total x-ray on time
 helical total coverage= (exposure time * table velocity)
 axial or cine total coverage = macro row thickness * no of active rows
 Slice thickness = nominal prospective reconstructed slice selection

Exposure.ppt
T. Toth 03-Aug-04

Note:

A.4.5 Frame of Reference Module

Attribute Name	Tag	Type	Notes
Frame of Reference UID	(0020,0052)	1	See Caution below.
Position Reference Indicator	(0020,1040)	2	Value as entered at the user interface.

CAUTION

It is possible for the operator of GEHC CT system to change the table height while scanning a series of images. Therefore, implementations must use the Frame of Reference UID (0020,0052) in conjunction with the Table Height (0018,1130) to determine if two images are spatially related.

A.4.6 Other Attributes

Attribute Name	Tag	Type	Notes
Temporal Position Index	(0020,9128)	3	Filled into CT image for some applications. Pass number for shuttle images.
Nominal Percentage of Cardiac Phase	(0020,9241)	3	Filled into CT image for some applications. Prescribed percentage of cardiac phase.
Creator Version UID	(0008,9123)	3	Unique identifier filled into CT GSI

			images to capture the version of raw data.
--	--	--	--

A.5 SC Image Modules

A.5.1 SC Equipment Module

Attribute Name	Tag	Type	Notes
Conversion Type	(0008,0064)	1	Always sent with value WSD
Modality	(0008,0060)	3	Modality of original image. This will not be sent, if its value is NULL.

A.5.2 Image Pixel Module

Attribute Name	Tag	Type	Notes
Samples per Pixel	(0028,0002)	1	Always sent with value = 1
Photometric Interpretation	(0028,0004)	1	Always sent.
Rows	(0028,0010)	1	Always sent
Columns	(0028,0011)	1	Always sent
Bits Allocated	(0028,0100)	1	Always sent with value = 16
Bits Stored	(0028,0101)	1	Always sent with value = 16
High Bit	(0028,0102)	1	Always sent with value = 15
Pixel Representation	(0028,0103)	1	Always sent with value = 1
Pixel Data	(7FE0,0010)	1	Always sent

A.5.3 Modality LUT Module

Attribute Name	Tag	Type	Notes
Rescale intercept	(0028,1052)	1C	Always sent
Rescale Slope	(0028,1053)	1C	Always sent
Rescale Type	(0028,1054)	1C	Always sent with value = HU

APPENDIX B: Private Data Elements

Enclosed is a listing of private data elements used in this implementation for CT Image IOD definition.

B.1 CT Image IOD Private Data Elements Definition

B.1.1 Private Creator Identification (GEMS_IDEN_01)

Attribute Name	Tag	VR	VM
Full fidelity	(0009,1001)	LO	1
Suite id	(0009,1002)	SH	1
Product id	(0009,1004)	SH	1
Image actual date	(0009,1027)	SL	1
Equipment UID	(0009,10E3)	UI	1

Note: For all images created by GEHC CT system (0009,1001) element will have the value "CT_LIGHTSPEED".

B.1.2 Private Creator Identification (GEMS_ACQU_01)

Attribute Name	Tag	VR	VM
Number of cells I in Detector	(0019,1002)	SL	1
Cell number at Theta	(0019,1003)	DS	1
Cell spacing	(0019,1004)	DS	1
Horiz. Frame of ref.	(0019,100F)	DS	1
Series contrast	(0019,1011)	SS	1
First scan ras	(0019,1018)	LO	1
Last scan ras	(0019,101A)	LO	1
Table speed	(0019,1023)	DS	1
Mid scan time	(0019,1024)	DS	1
Mid scan flag	(0019,1025)	SS	1
Degrees of azimuth	(0019,1026)	SL	1
Gantry period	(0019,1027)	DS	1
Number of triggers	(0019,102C)	SL	1
Angle of first view	(0019,102E)	DS	1
Trigger frequency	(0019,102F)	DS	1
Scan FOV type	(0019,1039)	SS	1
Segment number	(0019,1042)	SS	1
Total segments requested	(0019,1043)	SS	1
View compression factor	(0019,1047)	SS	1
Recon post proc. Flag	(0019,1052)	SS	1

Attribute Name	Tag	VR	VM
Dependent on #views processed	(0019,106A)	SS	1

B.1.3 Private Creator Identification (GEMS_RELA_01)

Attribute Name	Tag	VR	VM
Series from which Prescribed	(0021,1003)	SS	1
Series Prescribed From	(0021,1035)	SS	1
Image Prescribed From	(0021,1036)	SS	1
Biopsy position	(0021,1091)	SS	1
Biopsy T location	(0021,1092)	FL	1
Biopsy ref location	(0021,1093)	FL	1

B.1.4 Private Creator Identification (GEMS_STDY_01)

Attribute Name	Tag	VR	VM
Start time(secs) in first axial	(0023,1070)	FD	1

B.1.5 Private Creator Identification (GEMS_IMAG_01)

Attribute Name	Tag	VR	VM
Scout Type	(0027,1010)	SS	1
Vma mamp	(0027,101C)	SL	1
Vma mod	(0027,101E)	SL	1
GE Noise Index * 10	(0027,101F)	SL	1
Smart scan ON/OFF flag	(0027,1020)	SS	1
Plane Type	(0027,1035)	SS	1
Center R coord of plane image	(0027,1042)	FL	1
Center A coord of plane image	(0027,1043)	FL	1
Center S coord of plane image	(0027,1044)	FL	1
Normal R coord	(0027,1045)	FL	1
Normal A coord	(0027,1046)	FL	1
Normal S coord	(0027,1047)	FL	1
Table start location	(0027,1050)	FL	1
Table end location	(0027,1051)	FL	1

B.1.6 Private Creator Identification (GEMS_0039)

Attribute Name	Tag	VR	VM
SR Application Name	(0039,1095)	LO	1

B.1.7 Private Creator Identification (GEMS_CT_FLRO_1)

Attribute Name	Tag	VR	VM
CT Int Fluoro	(0029,1001)	SS	1

Attribute Name	Tag	VR	VM
Image Precise Location	(0029,1002)	DS	1

B.1.8 Private Creator Identification (GEMS_PARM_01)

Attribute Name	Tag	VR	VM
Window value	(0043,1010)	US	1
X-ray chain	(0043,1012)	SS	3
Number of overranges	(0043,1016)	SS	1
Delta start time	(0043,101E)	DS	1
Max overranges in a view	(0043,101F)	SL	1
Corrected after glow terms	(0043,1021)	SS	1
Reference channels	(0043,1025)	SS	6
No views ref chans blocked	(0043,1026)	US	4
Scan pitch ratio	(0043,1027)	SH	1
Unique image iden	(0043,1028)	OB	1
Private Scan Options	(0043,102B)	SS	4
RA cord of target recon center	(0043,1031)	DS	2
Trigger on position	(0043,1040)	FL	1
Degree of rotation	(0043,1041)	FL	1
DAS trigger source	(0043,1042)	SL	1
DAS fpa gain	(0043,1043)	SL	1
DAS output source	(0043,1044)	SL	1
DAS ad input	(0043,1045)	SL	1
DAS cal mode	(0043,1046)	SL	1
Start scan to X-ray on delay	(0043,104D)	FL	1
Duration of X-ray on	(0043,104E)	FL	1
Recon filter	(0043,1064)	LO	1

B.1.9 Private Creator Identification (GEMS_HELIOS_01)

Note: DICOM elements (0045, 1030-1034) and (0045, 1036-1039) and (0045, 103B) are present only if the appropriate cardiac option is installed on the scanner.

Attribute Name	Tag	VR	VM
Number of Macro Rows in Detector	(0045, 1001)	SS	1
Macro width at ISO Center	(0045, 1002)	FL	1
DAS type	(0045, 1003)	SS	1
DAS gain	(0045, 1004)	SS	1
DAS Temperature	(0045, 1005)	SS	1
Table Direction	(0045, 1006)	CS	1
Z smoothing Factor	(0045, 1007)	FL	1
View Weighting Mode	(0045, 1008)	SS	1
Sigma Row number	(0045, 1009)	SS	1
Minimum DAS value	(0045, 100A)	FL	1

Attribute Name	Tag	VR	VM
Maximum Offset Value	(0045, 100B)	FL	1
Number of Views shifted	(0045, 100C)	SS	1
Z tracking Flag	(0045, 100D)	SS	1
Mean Z error	(0045, 100E)	FL	1
Z tracking Error	(0045, 100F)	FL	1
Start View 2A	(0045, 1010)	SS	1
Number of Views 2A	(0045, 1011)	SS	1
Start View 1A	(0045, 1012)	SS	1
Sigma Mode	(0045, 1013)	SS	1
Number of Views 1A	(0045, 1014)	SS	1
Start View 2B	(0045, 1015)	SS	1
Number Views 2B	(0045, 1016)	SS	1
Start View 1B	(0045, 1017)	SS	1
Number of Views 1B	(0045, 1018)	SS	1
Iterbone Flag	(0045, 1021)	SS	1
Peristaltic Flag	(0045, 1022)	SS	1
CardiacReconAlgorithm	(0045, 1030)	CS	1
AvgHeartRateForImage	(0045, 1031)	CS	1
TemporalResolution	(0045, 1032)	FL	1
PctRpeakDelay	(0045, 1033)	CS	1
ActualPctRpeakDelay	(0045, 1034)	CS	1
EkgFullMaStartPhase	(0045, 1036)	CS	1
EkgFullMaEndPhase	(0045, 1037)	CS	1
EkgModulationMaxMa	(0045, 1038)	CS	1
EkgModulationMinMa	(0045, 1039)	CS	1
NoiseReductionImageFilterDesc	(0045, 103B)	LO	1
RPeakTimeDelay	(0045, 103F)	IS	1
ActualRPeakTimeDelay	(0045, 1044)	IS	1
CardiacScanOptions	(0045, 1045)	ST	1

B.1.10 Private Creator Identification (GEMS_CT_CARDIAC_001)

Note: Private Group 49 is present only if the appropriate cardiac option is installed on the scanner.

Attribute Name	Tag	VR	VM
CT Cardiac Sequence	(0049, 1001)	SQ	1
HeartRateAtConfirm	(0049, 1002)	CS	1
AvgHeartRatePriorToConfirm	(0049, 1003)	FL	1
MinHeartRatePriorToConfirm	(0049, 1004)	CS	1
MaxHeartRatePriorToConfirm	(0049, 1005)	CS	1
StdDevHeartRatePriorToConfirm	(0049, 1006)	FL	1
NumHeartRateSamplesPriorToConfirm	(0049, 1007)	US	1
AutoHeartRateDetectPredict	(0049, 1008)	CS	1
SystemOptimizedHeartRate	(0049, 1009)	CS	1

EkgMonitorType	(0049, 100A)	ST	1
NumReconSectors	(0049, 100B)	CS	1
RpeakTimeStamps	(0049, 100C)	FL	1-256
EkgGatingType	(0049, 1016)	SH	1
EkgWaveTimeOffFirstDataPoint	(0049, 101B)	FL	1
TemporalAlg	(0049, 1022)	CS	1
PhaseLocation	(0049, 1023)	CS	1
PreBlendedCycle1	(0049, 1024)	OW	1
PreBlendedCycle2	(0049, 1025)	OW	1
CompressionAlg	(0049, 1026)	CS	1

B.1.11 Private Creator Identification (GEHC_CT_ADVAPP_001)

Note: Private tags (0053, 1001) through (0053,1003) and (0053,1070) through (0053,109F) are only present for multi-energy CT images.

Attribute Name	Tag	VR	VM
MultiEnergyNoiseRedBlendingFactor	(0053, 1001)	FL	1-n
MultiEnergyNoiseRedScaleFactor	(0053, 1002)	FL	1-n
MultiEnergyMDTransformEnergies	(0053, 1003)	IS	2
ShuttleFlag	(0053, 1020)	IS	1
TableSpeedNotReachesTargetFlag	(0053, 1021)	IS	1
IterativeReconAnnotation	(0053, 1040)	SH	1
IterativeReconMode	(0053, 1041)	SH	1
IterativeReconConfiguration	(0053, 1042)	LO	1
IterativeReconLevel	(0053, 1043)	SH	1
reconFlipRotateAnno	(0053, 1060)	SH	1
HiResMode	(0053, 1061)	SH	1
RespiratoryFlag	(0053, 1062)	SH	1
Image Position Patient Setting	(0053, 1063)	CS	1
Shutter Mode	(0053, 1064)	IS	1
Shutter Mode Percent	(0053, 1065)	IS	1
Image Browser Annotation	(0053, 1066)	LO	1
Overlapped Recon Flag	(0053, 1067)	IS	1
Row Number Anotation Flag	(0053, 1068)	IS	1
ImageCheckAnnotation	(0053, 1069)	LO	1
ODMFlag	(0053, 106A)	IS	1
ODMReductionPercent	(0053, 106B)	IS	1
multiEnergySourceCount	(0053, 1070)	IS	1
multiEnergyScanType	(0053, 1071)	LO	1
multiEnergyReconType	(0053, 1072)	LO	1
multiEnergyImageType	(0053, 1073)	LO	1
multiEnergyMaterialType	(0053, 1074)	LO	1
monochromaticEnergy	(0053, 1075)	DS	1
MultiEnergyWeightedSubtractionWeight1	(0053, 1076)	DS	1
MultiEnergyWeightedSubtractionWeight2	(0053, 1077)	DS	1

MultiEnergyWeightedSubtractionType	(0053, 1078)	LO	1
MultiEnergyAcqMethod	(0053, 1079)	LO	1
MultiEnergyFeatAnnotName	(0053, 107A)	SH	1
MultiEnergyNoiseReduced	(0053, 107B)	SH	1
MultiEnergyNoiseReducdeMethod	(0053, 107C)	LO	1
SubOptimallQString	(0053, 107D)	LO	1
MultiEnergyHighLowRatio	(0053, 107E)	DS	1
MultiEnergyDutyCycle	(0053, 107F)	DS	1
MeasuredEffectiveHighkVp	(0053, 1080)	DS	1
MeasuredEffectiveLowkVp	(0053, 1081)	DS	1
MeasuredEffectiveMeankVp	(0053, 1082)	DS	1
MeasuredEffectiveMeanmA	(0053, 1083)	DS	1
CommandedFirstkVp	(0053, 1084)	DS	1
CommandedFirstmA	(0053, 1085)	DS	1
CommandedSecondkVp	(0053, 1086)	DS	1
CommandedSecondmA	(0053, 1087)	DS	1
MultiEnergyKVAnnotName	(0053, 1088)	SH	1
MultiEnergyKVUnitLabel	(0053, 1089)	SH	1
MaterialType#1	(0053, 108A)	LO	1
MaterialType#2	(0053, 108B)	LO	1
GSIscanModePreset	(0053, 108C)	LO	1
MonoWindowLow	(0053, 108D)	IS	2
MonoWindoHigh	(0053, 108E)	IS	2
MD1AttenuationCurve	(0053, 108F)	FL	110
MD1intercept	(0053, 1092)	DS	1
MD1slope	(0053, 1093)	DS	1
MD1supportData	(0053, 1095)	OW	1
MD2supportData	(0053, 1096)	OW	1
NM1data	(0053, 1097)	OW	1
MD2intercept	(0053, 1098)	DS	1
MD2slope	(0053, 1099)	DS	1
NM2data	(0053, 109A)	OW	1
MD2attenuationCurve	(0053, 109B)	FL	110
GSIdataVersion	(0053, 109C)	SH	1
MARsAnnotation	(0053, 109D)	LO	1
MultiEnergyNumNoiseRedPairs	(0053, 109E)	IS	1
MultiEnergyNoiseRedString	(0053, 109F)	LO	1-n

APPENDIX C: DICOMDIR Directory Information

Enclosed here is a listing of only the optional (conditional) modules and optional attributes used by this implementation in the DICOMDIR definition. All standard attributes as defined in Part 3 Addendum (Basic Directory Information Object) are supported by this implementation but not listed here.

C.1 Basic Directory IOD Definition

Module	Usage	Notes
Directory Information	U	Sent
File Set Identification	M	Sent

C.2 File Set Identification Module

Attribute Name	Tag	Type	Notes
File Set ID	(0004,1130)	2	Set by application

C.3 Directory Information Module

Attribute Name	Tag	Type	Notes
Offset of the First Directory Record of the Root Directory Entity	(0004,1200)	1	Set by application
Offset of the Last Directory Record of the Root Directory Entity	(0004,1202)	1	Set by application
File-set Consistency Flag	(0004,1212)	1	0000H: no known inconsistencies.
Directory Record Sequence	(0004,1220)	2	Supported.
>Offset of the Next Directory Record	(0004,1400)	1	Set by application
>Record In-use Flag	(0004,1410)	1	FFFFH: record is in use
>Offset of Referenced Lower-Level Directory Entity	(0004,1420)	1	Set by application
>Directory Record Type	(0004,1430)	1	"PATIENT", "STUDY", "SERIES", "IMAGE", "PRESENTATION" and "SR DOCUMENT"
>Referenced File ID	(0004,1500)	1C	Generated only for Image, Presentation and SR Document Directory Records, starting with A/A/A/A/Z01.
>Referenced SOP Class UID in file	(0004,1510)	1C	Generated only for Image,

			Presentation and SR Document Directory Records
>Referenced SOP Instance UID in File	(0004,1511)	1C	Generated only for Image, Presentation and SR Document Directory Records. Set to SOP Instance UID (0008,0018) during save to media.
>Referenced Transfer Syntax UID in File	(0004,1512)	1C	Generated only for Image, Presentation and SR Document Directory Records
>Record Selection Keys			See C.4

C.4 Definition of Specific Directory Records

STD-GEN-CD, STD-GEN-DVD-JPEG and STD-GEN-USB-JPEG Application Profiles will have PATIENT, STUDY, SERIES, IMAGE, PRESENTATION and SR DOCUMENT directory record types. Given below are the attributes supported under each of these directories.

Additional Keys column in each list specifies whether each key is an additional key for STD-GEN-CD, STD-GEN-DVD-JPEG and STD-GEN-USB-JPEG or not.

C.4.1 Patient Directory Record Definition

Attribute Name	Tag	Type (for CD)	Type (for DVD / USB)	Notes
Specific Character Set	(0008,0005)	1C	1C	ISO_IR 100
Patient's Name	(0010,0010)	2	2	If present in composite object instances it will be set to same value, otherwise set to NULL
Patient ID	(0010,0020)	1	1	If present in composite object instances it will be set to same value, otherwise method as stated in section C.4.1.1 is followed to set the value.
Patient Birth Date	(0010,0030)	E	1C	If present in composite object instances it will be set to same value, otherwise not present
Patient Birth Time	(0010,0032)	E	E	If present in composite object instances it will be set to same value, otherwise not present
Patient Sex	(0010,0040)	E	1C	If present in composite object instances it will be set to same value, otherwise not present

NOTE: E represents Standard Extended Element

C.4.1.1 Methods to set Patient ID

```

dummyPatID = 0;
if (patientID is present in the image)
{
    put patientID value in DICOMDIR
}
else
{
    if (current image is of same study)
    {
        put "no_patID" + dummyPatID
    }
    else if (current image is not of same study)
    {
        put "no_patID" + (++dummyPatID)
    }
}
  
```

Later point of time, if we get the patient ID then the above dummy patient ID should be updated with the actual patient ID.

Scenario:

=====

For example if we are adding 8 images, and 4 images are of Series S1 and 4 images are of series S2 belonging to the same Study as S1. Series S1 images are not having any value for patient ID but series S2 images are having the value of patient ID. Now while DICOMDIR creation, initially we would put dummy patient ID value when iterating through series S1 but when we reach to the second series image then previously filled dummy patient ID should be filled with the actual patient ID found in series S2 images.

Another example: if several series belong to a same Study without Patient ID in any of the images, a single Patient ID (i.e. a single Directory Record) is assigned to this Study, and all Series are attached to the Study they belong to. Do not duplicate Study UIDs (i.e. do not generate two Directory Records with the same Study UID).

C.4.2 Study Directory Record Definition

Attribute Name	Tag	Type (for CD)	Type (for DVD / USB)	Notes
Specific Character Set	(0008,0005)	1C	1C	ISO_IR 100
Study Date	(0008,0020)	1	1	If present in composite object instances it will be set to same

				value, otherwise method as stated in sec C.4.2.1 is followed to set the value.
Study Time	(0008,0030)	1	1	If present in composite object instances it will be set to same value, otherwise method as stated in sec C.4.2.1 is followed to set the value.
Accession Number	(0008,0050)	2	2	If present in composite object instances it will be set to same value, otherwise set to NULL
Study Description	(0008,1030)	2	2	If present in composite object instances it will be set to same value, otherwise set to NULL
Study Instance UID	(0020,000D)	1C	1C	This is set to value that is present in the composite object instances, otherwise composite object instances are not Archived.
Study ID	(0020,0010)	1	1	If present in composite object instances it will be set to same value, otherwise method as stated in section C.4.2.2 is followed to set the value

C.4.2.1 Method to set Study Date and Time

```

if (studyDateTime is present)
{
    put its value in DICOMDIR
}
else
{
    look for seriesDateTime
    if (seriesDateTime is present)
    {
        put seriesDateTime value in DICOMDIR
    }
    else
    {
        look for acquisitionDateTime (either ((0008,0022),(0008,0032)) or (0008,002A))
        if (acquisitionDateTime is present)
        {
            put acquisitionDateTime value in DICOMDIR
        }
        else
        {
            look for contentDateTime
            if(contentDateTime is present)

```

```

    {
        put contentDateTime value in DICOMDIR
    }
    else
    {
        look for instanceCreationDateTime
        if(instanceCreationDateTime is present)
        {
            put instanceCreationDateTime value in DICOMDIR
        }
        else
        {
            put a DummyDateTime
        }
    }
  }
}

```

Ideally, the oldest Date-Time found among all images belonging to the Study should be stored in DICOMDIR.

C.4.2.2 Method to set Study ID

```

if (studyID is present in the image)
{
    put studyID value in DICOMDIR
}
else
{
    put a dummy studyID value in DICOMDIR. please take care of the length (< 16)
}

```

Later point of time, if correct Study ID is found in any of the image present in the Study then dummy Study ID has to be replaced with correct one.

C.4.3 Series Directory Record Definition

Attribute Name	Tag	Type (for CD)	Type (for DVD / USB)	Notes
Specific Character Set	(0008,0005)	1C	1C	ISO_IR 100
Image Type	(0008,0008)	E	E	If present in composite object instances it will be set to same value, otherwise not sent
Modality	(0008,0060)	1	1	If present in composite object instance it will be set to same value, otherwise an error is

				returned and the object not put on media
Manufacturer	(0008,0070)	E	E	If present in composite object instances it will be set to same value, otherwise not sent
Institution Name	(0008,0080)	E	1C	If present in composite object instances it will be set to same value, otherwise not sent
Institution Address	(0008,0081)	E	1C	If present in composite object instances it will be set to same value, otherwise not sent
Series Description	(0008,103E)	E	3	If present in composite object instances it will be set to same value, otherwise not sent
Performing Physician's Name	(0008,1050)	E	1C	If present in composite object instances it will be set to same value, otherwise not sent
Manufacturer's Model Name	(0008,1090)	E	E	If present in composite object instances it will be set to same value, otherwise not sent
Series Instance UID	(0020,000E)	1	1	This is set to value that is present in the composite object instance, otherwise check for presence of Referenced SOP Instance UID in File (0004,1511), if both not present, instance is not put on media.
Series Number	(0020,0011)	1	1	If present in composite object instance, it will be set to same value, otherwise method as stated in section C.4.3.1 is followed to set the value.

NOTE: E represents Standard Extended Element.

C.4.3.1 Method to set Series Number

```

dummySeriesNum = 0;
if (seriesNum is present in image)
{
    put seriesNum value in DICOMDIR
}
else
{
    if (same series)
    {
        put dummySeriesNum value in DICOMDIR
    }
}

```

```

else (different series)
{
    put (++dummySeriesNum) value in DICOMDIR
}
}

```

Later point of time, if correct series Num is found in any of the image present in the series then dummy series number has to be replaced with correct one.

C.4.4 Image Directory Record Definition

Attribute Name	Tag	Type (for CD)	Type (for DVD / USB)	Notes
Specific Character Set	(0008,0005)	1C	1C	ISO_IR 100
Image Type	(0008,0008)	1C	1C	If present in composite object instances it will be set to same value, otherwise not sent
SOP Instance UID	(0008,0018)	E	E	Same as (0004,1511)
Acquisition Datetime	(0008,002A)	E	1C	If present in composite object instances it will be set to same value, otherwise not sent.
Acquisition Time	(0008,0032)	E	E	If present in composite object instances it will be set to same value, otherwise not sent
Referenced Image Sequence	(0008,1140)	1C	1C	If present in composite object instances it will be set to same value, otherwise not sent
>Reference SOP Class UID	(0008,1150)	1C	1C	Required if Referenced Image Sequence (0008,1140) is present
>Reference SOP Instance UID	(0008,1155)	1C	1C	Required if Referenced Image Sequence (0008,1140) is present
Slice Thickness	(0018,0050)	E	E	Included
Spacing Between Slices	(0018,0088)	E	E	Included
Data Collection Diameter	(0018,0090)	E	E	Included

Reconstruction Diameter	(0018,1100)	E	E	Included
Gantry/Detector Tilt	(0018,1120)	E	E	Included
Convolution Kernel	(0018,1210)	E	E	Included
Acquisition Time Synchronized	(0018,1800)	E	1C	If present in composite object instances it will be set to same value, otherwise not sent.
Image Number	(0020,0013)	1	1	If present in composite object instances it will be set to same value. otherwise method as stated in section C.4.4.1 is followed to set the value.
Image Position (Patient)	(0020,0032)	E	1C	If present in composite object instances it will be set to same value, otherwise not sent
Image Orientation (Patient)	(0020,0037)	E	1C	If present in composite object instances it will be set to same value, otherwise not sent
Frame of Reference UID	(0020,0052)	E	1C	If present in composite object instances it will be set to same value, otherwise not sent
Synchronization Frame of Reference UID	(0020,0200)	E	1C	If present in composite object instances it will be set to same value, otherwise not sent
Slice Location	(0020,1041)	E	E	Included
Number of Frames	(0028,0008)	E	1C	Not included
Rows	(0028,0010)	E	1	If present in composite object instances it will be set to same value, otherwise an error is returned
Columns	(0028,0011)	E	1	If present in composite object instances it will be set to same value, otherwise an error is returned
Pixel Spacing	(0028,0030)	E	1C	If present in composite object instances it will be set to same value, otherwise not sent

Bits Allocated	(0028,0100)	E	1	Not included
Bits Stored	(0028,0101)	E	1	Not included
High Bit	(0028,0102)	E	1	Not included
Lossy Image Compression Ratio	(0028,2112)	E	1C	If present in composite object instances it will be set to same value, otherwise not sent
Calibration Image	(0050,0004)	E	1C	If present in composite object instances it will be set to same value, otherwise not sent

NOTE: E represents Standard Extended Element.

C.4.4.1 Method to set Image Number

```

dummyImageNum = 0;
if (imageNum is present in image)
{
    put imageNum value in DICOMDIR
}
else
{
    put ++ dummyImageNum in DICOMDIR
}

```

C.4.5 Presentation Directory Record Definition

Attribute Name	Tag	Type (for CD)	Type (for DVD / USB)	Notes
Specific Character Set	(0008,0005)	1C	1C	ISO_IR 100
SOP Instance UID	(0008,0018)	E	E	Same as (0004,1511)
Referenced Series Sequence	(0008,1115)	1C	1C	Calculated and sent.
> Referenced Image Sequence	(0008,1140)	1	1	Always sent, references images selected.
>> Reference SOP Class UID	(0008,1150)	1	1	Always sent
>> Reference SOP Instance UID	(0008,1155)	1	1	Always sent
> Series Instance UID	(0020,000E)	1	1	Always sent, references series

				selected
Image Number	(0020,0013)	1	1	If present in composite object instances it will be set to same value. otherwise method as stated in section C.4.4.1 is followed to set the value. Set to 23 and sent.
Content Label	(0070,0080)	1	1	Exam Split : This will be set as "PGP" plus Requested Procedure Code Meaning or Requested Procedure Description converted to all capital letters and truncated to 16 characters. Save State : "GEGSPS_0"
Content Description	(0070,0081)	2	2	Exam Split : String input on Comments box in Exam Split screen Save State : "SE (Series Number) IM (First Image Number) TO IM (Last Image Number)"
Presentation Creation Date	(0070,0082)	1	1	Calculated and sent.
Presentation Creation Time	(0070,0083)	1	1	Calculated and sent.
Content Creator's Name	(0070,0084)	2	2	Same as Station Name(0008,1010)

NOTE: E represents Standard Extended Element.

C.4.6 Structured Report Directory Record Definition

Attribute Name	Tag	Type (for CD)	Type (for DVD / USB)	Notes
Specific Character Set	(0008,0005)	1C	1C	ISO_IR 100
SOP Instance UID	(0008,0018)	E	E	Same as (0004,1511)
Image Date	(0008,0023)	1	1	Generated for each image, always sent.
Image Time	(0008,0033)	1	1	Generated for each image, always sent.
Image Number	(0020,0013)	1	1	If present in composite object instances it will be set to same

				value. otherwise method as stated in section C.4.4.1 is followed to set the value.
Concept Name Code Sequence	(0040,A043)	1	1	A coded representation of the document title.
>Code Value	(0008,0100)	1	1	Always sent
>Coding Scheme Designator	(0008,0102)	1	1	Always sent
>Code Meaning	(0008,0104)	1	1	Always sent
Completion Flag	(0040,A491)	1	1	COMPLETE sent
Verification Flag	(0040,A493)	1	1	UNVERIFIED sent
Content Sequence	(0040,A730)	1C	1C	Contains the Target Content Items that modify the Concept Name Code Sequence of the root Content Item (Document Title). One or more Items shall be included in this Sequence. All, and only, Content Items with the HAS CONCEPT MOD relationship from the root Content Item shall be included in this Sequence. Required if the root Content Item is the Source Content Item of HAS CONCEPT MOD relationships.
>Relationship Type	(0040,A010)	1	1	Enumerated Value: HAS CONCEPT MOD

NOTE: E represents Standard Extended Element.

APPENDIX D: Implementation UID for Product Versions

Product Model	Software Revision	Implementation UID
Revolution™ Discovery™ CT	14MW24.7	1.2.840.113619.6.340
Discovery™ CT	14MW24.7	1.2.840.113619.6.340
Discovery™ CT750 HD	14MW24.7	1.2.840.113619.6.340

GE Healthcare
3000 N. Grandview Blvd., Waukesha, WI 53188 U.S.A.

www.gehealthcare.com

